

Washing Machine

Front Loading

Model

BD-120XGV

BD-100XGV



BD-120GV

BD-100GV

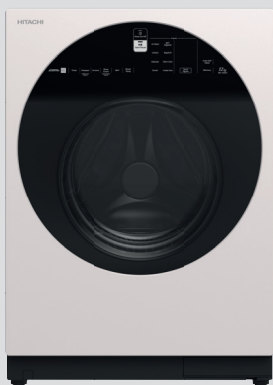

Thank you for purchasing a Hitachi front loading washing machine.

- Please read this Instruction Manual carefully for proper operation of the machine.
- Please keep this Instruction Manual for future reference.

Contents

Preparation for use

Environmentally Friendly Waste Disposal...	2
Hints and Tips for Eco-friendly Washing	2
Parts and Accessories	3
Safety Instructions	4
Precautions for using the wireless LAN function	7
How to Install the Washing Machine	10
Control Panel and Display	16
Use with smartphones	19
Before You Start Washing	26

Operation

How to Use the Washing Machine	27
Control your Washing Machine with your Smartphone.....	29
How to View the App.....	30
When the "NEW" symbol appears in the App version information	31
Checking the MAC address	32
How to put the detergent and softener.....	33
Program Overview.....	36
How to Use the Washing Machine Program.....	38

Maintenance

Convenient Usage	43
In Case of Emergency	46
Care and Maintenance	47
Troubleshooting	58
Error Codes.....	65
Specifications	66

For household use only

EN

3CS
ONLY

Environmentally Friendly Waste Disposal

Disposing of the packaging

The shipping package has protected your new washing machine on its way to your home. All materials are ecologically harmless and recyclable. Please contribute to a better environment by disposing of packaging materials in an environmentally conscious manner.

Ask your dealer about current means of disposal.

Risk of choking!

Do not let children play with packaging and associated parts.

Risk of choking on plastic film and collapsible boxes.

Disposing of your old appliance

Old appliances are not worthless rubbish. Environment-conscious recycling can reclaim them to valuable new materials.

Risk of death!

Unplug the power plug from appliances you are no longer using. Cut off the power cord and dispose of it with the plug.

Destroy the lock on the door. To prevent playing children from being trapped and endangered, ensure that the door locking mechanism is disabled.

If you wish to discard this product, please contact your local authorities or dealer and ask for the correct method of disposal.

Hints and Tips for Eco-friendly Washing

- Keep to the load limit of each program.
- Your washing machine automatically adjusts the operating time and amount of water of each program depending on the load.
- You only need to use the Prewash or Intensive options if your laundry is heavily soiled.
- Add detergent according to the degree of soiling, laundry size and water hardness, and follow the detergent manufacturer's instructions.
- Using the Cotton program with water temperature at 60°C setting instead of the Cotton program with water temperature at 90°C will save energy, and will remove ordinary stains. Better still, in areas where the temperature is high, you can remove ordinary stains without using hot water by setting 'Cold' programs for more economically friendly operation.

Parts and Accessories

Dispenser

For model : BD-120XGV/BD-100XGV

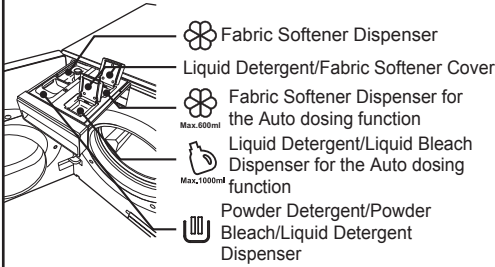

Dispenser

For model : BD-120GV/BD-100GV

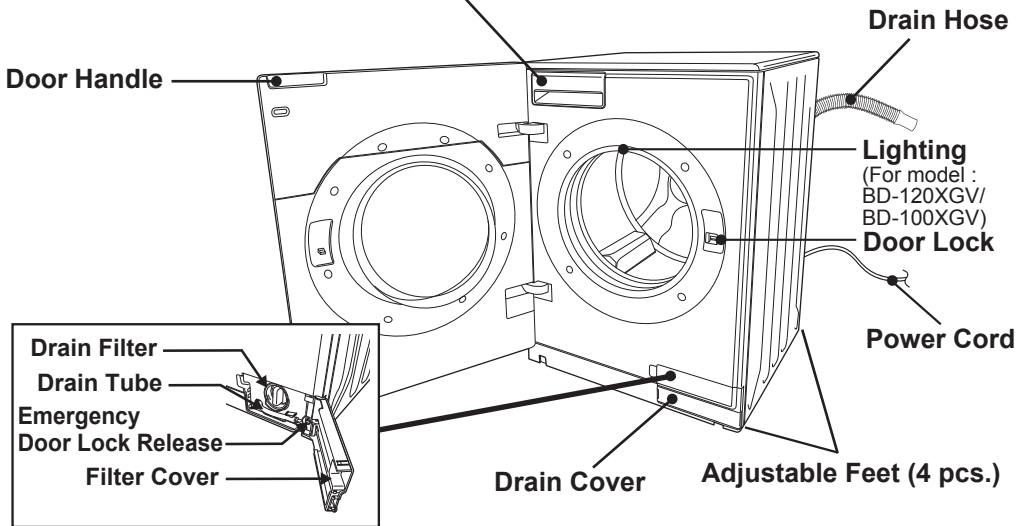
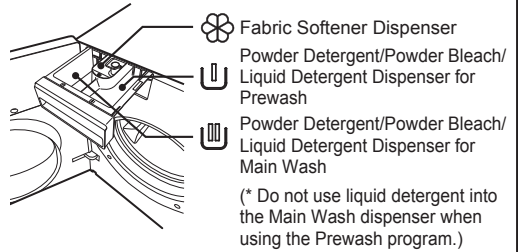

Packed-In Accessories

Either type of water supply hose is packed in by the demand of different area.

Water Supply Hose & One-touch Joint

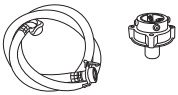

Water Supply Hose (Screw Type)



Hose Guide



(1 piece)

Spanner



(1 piece)

Cover Caps



(4 piece)

Safety Instructions

This washing machine is designed for home use only.

Before operating the washing machine, please read these safety instructions carefully.

- This appliance is intended to be used in household and similar applications such as: (IEC 60335-2-7)
 - staff kitchen areas in shops, offices and other working environments.
 - farm houses.
 - by clients in hotels, motels and other residential type environments.
 - bed and breakfast type environments.
 - areas for communal use in blocks of flats or in launderettes.

WARNING

Issues which could cause death or serious injury.

General safety

- Do not dismantle, repair or modify the appliance.
 - This could cause malfunction, fire, electric shock or injury.
 - For repair, please contact your local service center.
- Do not put fire sources or anything inflammable in or near the washing machine (gas, diesel, petrol, thinner, alcohol or clothes stained with these substances).
 - This could cause an explosion or fire.
- Do not pour water on the machine when it is running.
 - This could cause an electric shock.
- Do not climb on the washing machine.
 - This may cause injury.
- Do not put heavy objects on the washing machine.
 - This may damage the surface of the worktop.
- It is a malfunction if the drum is still rotating when the door is open. In this case never touch the drum nor laundry inside and stop using the washing machine immediately, and contact your local service center for repair.
- This appliance is not intended for use by persons (including children) with reduced physical, sensory or mental capabilities, or lack of experience and knowledge, unless they have been given supervision or instruction on how to use the appliance safely.

Installation

- The installation of the appliance should be done by the manufacturer's dealer or service agent.
 - If the installation, test run and inspection of the appliance are not carried out following the installation method outlined in these instructions, the manufacturer is not liable for any accident or damage caused.
- Do not install in a damp place such as a bathroom or a place exposed to rain.
 - Risk of fire, electric shock, current leakage or product damage.
- Do not install on a board with castors or an unstable surface.
 - This may cause injury or malfunction due to abnormal vibration.
- Do not use a plug adapter to convert 3 pins to 2 pins. (The washing machine must be grounded)
 - This could cause an electric shock.
- The opening must not be obstructed by carpeting when the washing machine is installed on a carpet floor.
- If the washing machine is to be connected to the water mains, please use new water supply hose.

Power source and cord

- Do not insert the plug with a wet hand.
→ This could cause an electric shock.
 - Use the rated mains voltage and do not connect another plug at the same socket.
→ Using the washing machine plug together with other electrical systems may cause overheating in the plug and result in fire.
 - Clean off all the dust on the plug.
→ A dirty or dusty plug may cause a fire.
 - Do not use an electric socket or connection which is damaged or loose.
→ This could cause an electric shock or a short circuit which may start fire.
 - Do not mark, cut, modify, bend or fold the power cable.
→ A damaged power cable could cause fire or an electric shock.
 - Do not use a mains plug adaptor or an extension cable.
→ This could cause overheating which may cause a fire.
 - If the power supply plug is damaged, it must only be replaced by the authorized service agent or repairing shops appointed by the manufacturer in order to avoid a hazard.
-

Child safety

- Keep packaging out of reach of children and babies.
→ Danger of suffocation.
- Do not let children climb onto the washing machine or open the drum door, and do not leave a box or chair near the washing machine which could enable children to climb onto it.
→ This may cause injury.
- Children should be supervised to ensure that they do not play with the washing machine.

 **CAUTION**

Issues which could cause injury or damage your belongings

General safety

- If there is a water outage or you remove the water supply hose and reattach it, turn off the tap and press the Start/Pause button, then turn on the tap slowly after 40 seconds.
→ Air pressure could damage the washing machine if there is a lot of air in the water pipe.
- Regularly check to confirm that the union nut of the water supply hose is tightened.
→ A loose nut may cause a water leak.
- Remove the plug from the socket and turn off the water tap if you don't use the machine for a long time.

Safety Instructions (Continue)

Use

- All transport bolts must be removed before using the washing machine.
→ They may cause abnormal vibration or failure.
 - Check inside the drum before washing.
→ Make sure that small pets do not climb into the drum.
 - Do not wash waterproof items such as raincoats, wet suits, ski suits, sleeping bags, cushions, pillows, shoes, etc.
→ The washing machine may not work properly, or the items may cause injury or damage the machine.
 - Do not operate without the detergent dispenser.
 - Do not use tap water hotter than 40°C.
 - Do not wash items together with coins, pins or stones.
→ This may damage clothes and the washing machine, and cause a water leak. Check inside pockets before washing.
 - Do not press the control panel with sharp or pointed objects.
 - Be careful when draining hot water.
 - Do not lean on or put weight on the opened door of the washing machine.
→ This may cause damage to the washing machine.
 - Do not attempt to open the door while it is operating.
 - Do not put heavy objects, liquid-filled containers or equipment which produces heat (e.g. oven, rice cooker, etc.) on the washing machine.
→ This may damage the washing machine or the surface of the worktop.
 - Do not insert your fingers or sticks into the hole in the front door lock. It may cause a malfunction.
 - Do not install the washing machine in an area with a temperature above 40°C or near heating equipment. If liquid detergent or fabric softener is still in the dispenser solution may deteriorate.
(For model : BD-120XGV/BD-100XGV)
-

Care and maintenance

- If detergent, fabric softener or bleach spills on the surface of the machine, clean it up with a damp cloth immediately.
→ The plastic or steel parts of the washing machine may be damaged.
- Do not place heat sources near the washing machine.
→ This may cause deformation of the machine.

Please read this manual and the "Safety Precautions" in the instruction manual supplied with this product to ensure correct usage. The following precautions are to be observed to prevent injury to the user or other persons or property damage. Please read the precautions in this manual carefully before using the product correctly.

- The following indications classify and dictate the degree of harm or damage that may result from improper use of the product without observing the indicated information. Please note that we are not responsible for any injury or damage that may result from not following these instructions.

 **WARNING**

The information in this column indicates that death or serious injury may occur.

Examples of picture displays

 The "prohibited" content is what you must not do.

 These are the "instructions" that you will be asked to carry out.

 **WARNING**

About the wireless LAN function (Remote control via wireless LAN function)



prohibited

- **Do not use near automatic doors or other automatic control devices.**
The radio waves from the wireless LAN may affect the automatic control equipment. This may lead to malfunctions.
- **Do not use it in a room with medical electrical equipment.**
The radio waves from the wireless LAN may affect the medical electrical equipment - this may lead to malfunctions.



instructions

- **Keep cardiac pacemakers away from the device.**
Radio waves from a wireless LAN may affect the operation of a cardiac pacemaker. If you have a cardiac pacemaker, please consult your doctor before using this device.

Precautions for using the wireless LAN function

We shall not be liable for any damage caused by misuse, malfunction, or any other failure of this product by you or any third party, except to the extent that we are legally liable for such damage.

Use this product as a general wireless LAN device in your home.

This product collects operating history and fault history for the following purposes. This product will not be used for any other purpose.

We use this information to:

- Develop and improve our services and quality.
- Improve our customer service for repair or advice.
- For more information on how we use your personal information, please see the App's terms of use. You can find the terms of use when you first start the App or click on the "Menu" button.

■ **Built-in wireless LAN adapter**

This product contains radio equipment that has been certified for radio stations for low-power data communication systems by the Radio Wave Law. It is unnecessary to apply for a radio station license, nor is it necessary for the telecommunications carrier to conduct an inspection. The following actions may be punishable by law.

- Dismantling or modifying the wireless LAN adapter built into the product.
- Removing the nameplate or the conformity marking of the built-in wireless equipment.

Precautions for using the wireless LAN function (Continue)

■ Wireless LAN Router

- Connection to all wireless LAN routers and wireless LANs in residential environments cannot be guaranteed.
- Radio reception may be lost or interrupted in buildings made of concrete, steel, or metal, near obstacles, or near devices that use the same frequency band (2.4GHz band) (such as Bluetooth® devices and computer peripherals).
- The communication standard must be one of the IEEE802.11b/g/n (2.4GHz band only). 5 GHz band communication standards are not supported.
- Connect this product to the internet via a router.
This product cannot be directly connected to the communication lines (including public wireless LAN) of telecommunication carriers (mobile communication companies, fixed-line communication companies, Internet providers, etc.).

■ Radio waves and Radio Interference

Specification of the communication method

Wireless LAN IEEE802.11b/g/n is supported.

Frequency bands used.

The specifications for the radio frequency bands used by this product are as follows (These are shown on the nameplate)

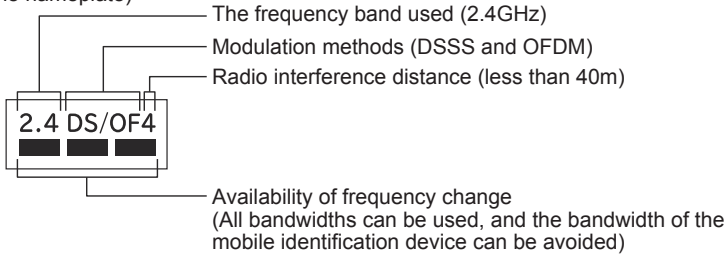

In the frequency band in which this product is used, industrial, scientific, and medical equipment as well as premises radio stations for mobile identification (licensed radio stations) and specified low-power radio stations (unlicensed radio stations) used in factory production lines, etc., and amateur radio stations (licensed radio stations) are in operation.

- ① Before using this product, make sure that there are no radio stations for mobile identification, specified low power radio stations, or amateur radio stations operating nearby.
- ② In the unlikely event that this product causes harmful interference to a mobile identification radio station, immediately change the frequency of use, or stop emitting radio waves. Consult with the consultation service counter for advice on connecting to a smartphone or network to avoid interference, such as the installation of partitions.
- ③ If any other problems arise involving harmful radio interference from this product to specified low-power radio stations for mobile identification or amateur radio stations, please contact the consultation service counter for advice on connecting to a smartphone or network.

Use of this product in the following locations may result in unstable communication:

- Dismantling areas where magnetic fields, static electricity, or radio waves are generated (including microwave ovens.)
- Around devices that use the same frequency band (2.4GHz band) as this product (Bluetooth® devices, PC peripherals, etc.)
- Places covered with metal objects that can easily reflect radio waves.

■ Security

- When using a wireless LAN device, regardless of the encryption settings, there is a possibility that the device will be intercepted due to its use of radio waves.
- Please use a wireless LAN router configured to use WPA2 or WPA (TKIP or AES) encryption.
- The wireless LAN function uses radio waves to exchange information between this product and a wireless LAN router. It has the advantage of allowing free LAN connections within the range of radio waves. Unauthorized persons may intercept the communication contents since the radio waves can reach anywhere within the range of the product, including obstacles (such as walls).
- Do not connect to devices or networks that you are not authorized to use when setting up the wireless LAN function.
- When disposing of the product or transferring it to a third party, please erase all registered information as described in the instruction manual included with the product.
- If the product is transferred from a third party, please erase all registered information in the instruction manual supplied with the product to prevent unauthorized access by a third party.

■ Pairing with a smartphone

- Do not connect to devices or networks that do not have security measures when setting up the wireless LAN function.
- In unforeseen circumstances, data stored inside smartphones or other external devices paired with this product may be damaged or lost.
Please ensure your data is backed-up, in the event of an emergency.
- In no event will we be liable for any damage to or loss of data stored in the smartphone or other external device or for any connected device's failure in connection with this product.
- In the event of a temporary loss of communication, the transmission of settings and the status of use may not be updated.
Please check the communication status while Operating.
- Depending on the type of smartphone or wireless LAN router, the communication sensitivity, communication distance, and communication time may vary. Please check the communication conditions before use.
- We are not responsible for any damage caused by the wireless LAN function, excluding the event of any defects to the product.

■ App Functionality

- The screens and illustrations in this manual are only for illustrative purposes and may differ from actual conditions.
- The contents of this service and functions are subject to change due to version upgrades of the application.
We reserve the right to suspend the service without notice.
You must agree to the App's Terms of Use and Privacy Policy before using the App.
- The App is not guaranteed to work on all smartphones and may be unstable or not work properly on some models.
- Please set the wireless LAN function of the washing machine to "On (The wireless LAN function)" to begin use the application.
The factory default setting is "On (The wireless LAN function)".

■ Export Controls

If this product is exported, please check the relevant foreign export laws and regulations, such as the Foreign Exchange and Foreign Trade Act and the US Export Administration Regulations, and take the necessary procedures.

■ Trademarks

The names of other companies, products, and services mentioned in this document and the instruction manual supplied with this product are the trademarks or registered trademarks of their respective owners. The "™" and "®" marks are not shown in the text.

1. "iPhone" is a trademark of Apple Inc. registered in the US and other countries. The trademark "iPhone" is used under license from Apple Inc., Ltd. "App Store" is a service mark of Apple Inc.
2. "Google Play", "Google Play logo" and "Android" and trademarks or registered trademarks of Google LLC.
3. Wi-Fi® is a registered trademark of Wi-Fi Alliance®.
4. Wi-Fi® Protected Setup™, WPA™, WPA2™ are trademarks of Wi-Fi Alliance®.
5. Bluetooth® is a registered trademark of Bluetooth SIG, Inc.
6. iOS is the Apple Inc. OS name. iOS is a registered trademark or trademark in the United States and other countries of Cisco Systems, Inc. or its affiliates and is used under license.
7. In addition, various names, company names, product names, etc., described in this manual are trademarks or registered trademarks of respective companies. And "™" and "®" marks are not described in some parts of the text.

■ Software Licensing

The software incorporated in this product consists of several independent software modules: the company's copyright and third parties. The product also contains software modules developed or created by the company, subject to the company's ownership and intellectual property rights and accompanying documentation. These software modules and accompanying documentation are the company's property and are protected by copyright and other laws. This product also contains software modules that are licensed as open-source software. The software module has a separate copyright holder and other rights, and is provided as it is because it is licensed free of charge. The software modules are provided without warranty of any kind, either express or implied, to the extent permitted by applicable law. To the extent permitted by applicable law, the company shall not be liable for or bear the costs of any damage arising from the use of the software module or its service (including loss of data, loss of accuracy, incompatibility with other programs, etc.).

For further information on the terms and conditions of use of this software module, please refer to the following URL. Since it is a regulation by a third party other than our company, the original (English) will be posted.

<https://kadenfan.hitachi.co.jp/app/sgp/cs-en/license.html>

For information on how to obtain this software module and about inquiry, please visit the following URL

<https://www.hitachi-homeappliances.com/sg/contact/index.html>

How to Install the Washing Machine

- The symbol is for checking whether you install the washing machine correctly.

Safety Instructions

- The washing machine is heavy. Use caution when lifting it.
- When lifting the washing machine, do not hold the door or adjustable leg. Lift the washing machine with two persons holding the bottom by one hand and the back of the washing machine by the other hand.



- Frozen hoses may tear/burst. Do not install the washing machine in areas where there is a risk of freezing, or outdoors.
- If the power supply plug is damaged, in order to avoid hazard, it must only be replaced by an authorized service agent or repair shop appointed by the manufacturer.
- Make sure to earth the unit. Failure to earth the unit may cause electric shock if an electric leak takes place.

Dimensions

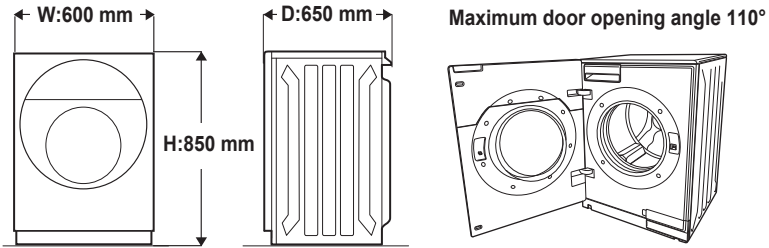

Where to install the washing machine

- Install the appliance on a flat hard floor to avoid excessive vibration and noise.
- Do not install the unit in humid places such as a bathroom or places that are exposed to wind and rain.
- Keep the minimum installation distance from the walls to prevent abnormal sound and vibration.
- For neater installation under the counter, check the height of internal measurement before fitting and adjust to the appropriate height with the adjustable feet.
→ Page 14 : How to Install the Washing Machine (Level Adjustment).

* Distance above installation under the counter case

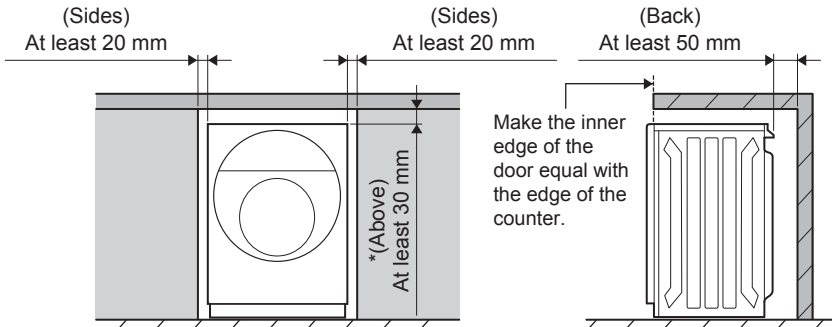

• The symbol  is for checking whether you install the washing machine correctly.

Removing the transport bolts

- Remove the four transport bolts using the spanner (P. 3; Packed-In Accessories). After that, insert the cover caps at these positions.
- The transport bolts must always be removed before using the washing machine for the first time and must be retained for any subsequent transport (e.g. when moving).

* Wear gloves before removing the transport bolts to prevent injury.

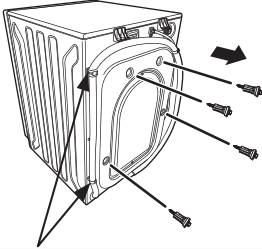

Do not remove these hose holders.

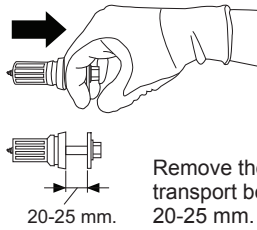

Remove the transport bolt out 20-25 mm. Then use your hand to pull straight out.

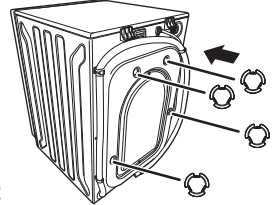

Insert the cover caps

Hose and cable length

• Connection on the left side

- Optimum Water Pressure : (0.03-0.8 MPa)
- Use cold water from the tap

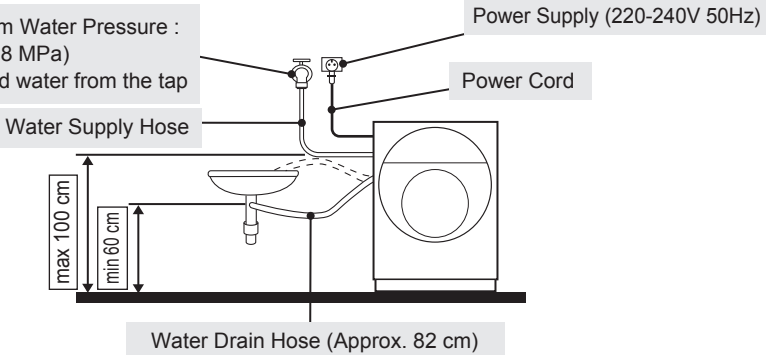

• Connection on the right side

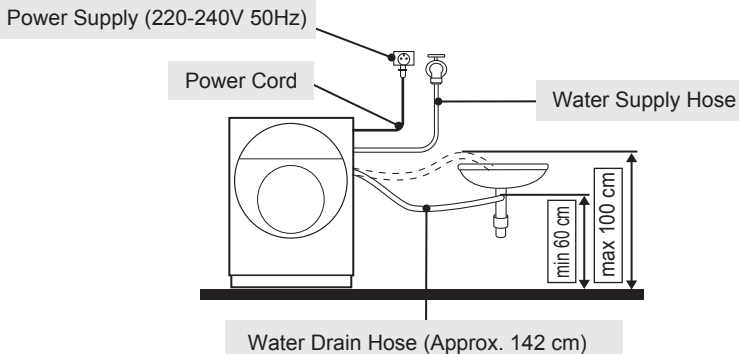

How to Install the Washing Machine (Continue)

• The symbol is for checking whether you install the washing machine correctly.

Connecting the water supply

• Water supply hose

- Optimum water pressure is 0.03-0.8MPa.
- Do not connect to the mixer tap of an unpressurised hot-water apparatus.
- Use a horizontal tap.

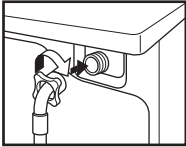
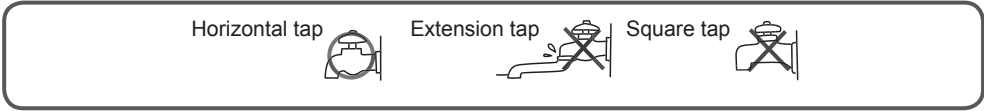

- Connect the water supply hose to the rear panel of the washing machine. Make sure that the rubber seal is inside the hose connector.

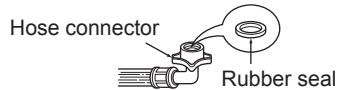

* Model with SCREW TYPE water supply hose.

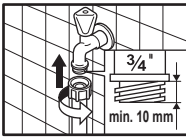

- Firmly connect the water supply hose to the tap, and check connection points for water-tightness.

* Model with ONE TOUCH JOINT water supply hose.

<p>1. Untighten the upper connector screw.</p> <ul style="list-style-type: none"> • In case the diameter of the tap is large, remove the guide plate. <p style="text-align: center;">Guide plate Connector</p>	<p>2. Push the upper connector up till the rubber packing is in tight contact with the tap. Then tighten the 4 screws.</p> <ul style="list-style-type: none"> • Turn the middle connector so that there is no water leak.
<p>3. Connect the water supply hose to the middle connector, pushing the plate down.</p> <p style="text-align: center;">Middle connector Water supply hose</p>	<ul style="list-style-type: none"> • To separate the water supply hose from the middle connector, turn off the tap, and then pull the inlet hose down, pushing the plate down.

• **The symbol □ is for checking whether you install the washing machine correctly.**

- Make sure that the union nut between the water supply hose and main unit is tightly screwed.
- Turn the tap on to check if the water supply hose is properly connected before starting. If it is loosely connected, water leakage may occur.

• **Drain hose**

- The drain hose should be placed higher than 60 cm above and not higher than 100 cm above the floor.

If the drain outlet is lower than 60 cm, a joint pipe is necessary (additional part, sold at a specialist outlet). Secure the drain hose to prevent from slipping out from joint pipe.

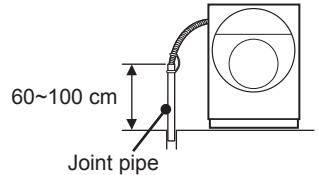

- Do not bend, twist, crush or pull out, bend or step on the drain hose. Use the hose guide to prevent the drain hose from kinking.
- Do not detach the drain hose from the rear panel of the washing machine.

Drainage into a wash basin (Using the packed-in hose guide) :

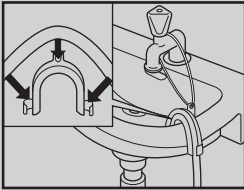

- Secure the drain hose to prevent it from slipping out of the wash basin.
- The wash basin outlet must not be sealed by a plug.
- When water is being pumped out of the washing machine, check that the water drains away quickly enough.

Drainage into a siphon :

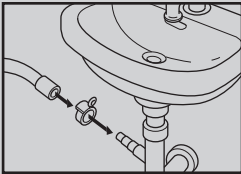

- Secure the connection point with 24-40 mm ϕ hose clip (Sold at a specialist outlet).

How to Install the Washing Machine (Continue)

- The symbol  is for checking whether you install the washing machine correctly.

Connecting the power

- Connect the washing machine to an alternating current via a correctly installed earthed socket only.
- The mains voltage must correspond to the voltage specification on the washing machine.
- Connection specifications as well as the required fuses are stipulated on the washing machine nameplate.
- Do not plug the washing machine into an extension lead or power strip with multiple sockets.

Level Adjustment

- All four adjustable feet must be firmly on the ground. The washing machine must not wobble.
- Check the alignment of the washing machine with a spirit level, and adjust the feet if it's not aligned.

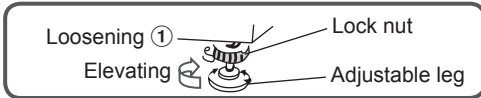

Loosen the lock nut by unscrewing in the arrow direction ① then stabilize the unit with the adjustable feet.

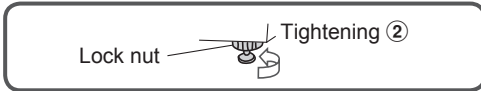

After adjustment, tighten the lock nut by screwing it in the arrow direction ②.

Metal base plate

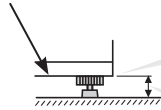

Tighten the lock nut until it reaches the metal base plate.

Adjustable leg is not over 25 mm.

Checking after installation

1. Turn on the water tap and close the washing machine door.
2. Press the Power On-Off button to switch power on.
3. Select the AI Wash program and press the Start/Pause button.
4. After 5 minutes, check if there is no water leakage from anywhere.
5. Press the Power On-Off button to switch power off.
6. Press the Power On-Off button again to switch power on.
7. Select the Spin program and press the Start/Pause button.
8. Check if there is no abnormal vibration or sound, and that water is drained out properly.

If any of the following conditions or other abnormalities occur, immediately pull out the power plug to prevent an accident and contact your local service center.

- The washing machine does not operate when you switch power on.
- The power cord has cracks.
- There are abnormal vibrations and sounds during operation.
- There is a smell of burning.

Before the first wash

Select the Cotton program with water temperature at 60°C setting and allow the unit to wash without clothing. This will remove residues and water that may have been left in the drum during manufacturing.

Customer Service

In case of malfunction of the washing machine, please check these Operating & Installation instructions carefully before you call for repair services.

If you are unable to identify or solve the problem, please contact your local service center.

Before calling, make a note of the model name, serial no. and purchase date of your washing machine. You can find the model name and serial no. on the label attached to the inside of filter cover.

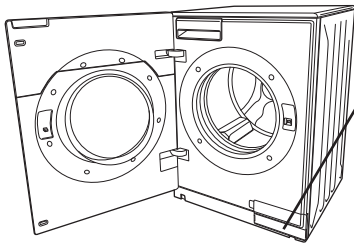







Model Name : XX-XXXXXX
Serial No : XXXXXXXX

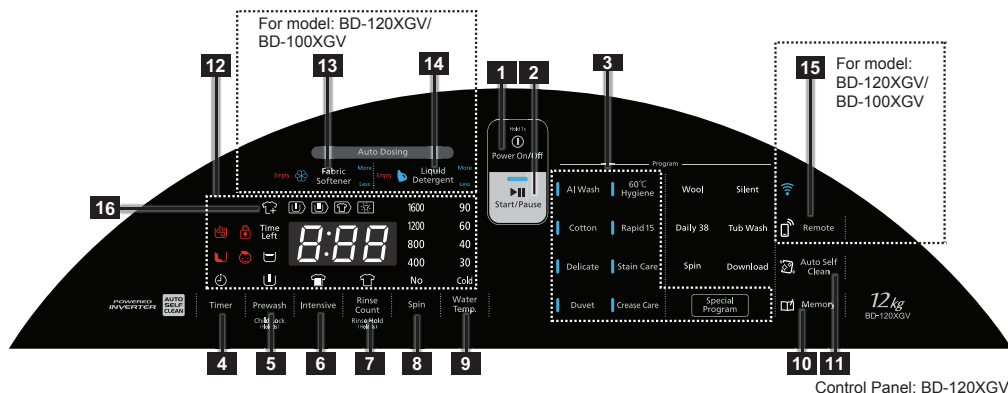





Control Panel and Display

NOTICE



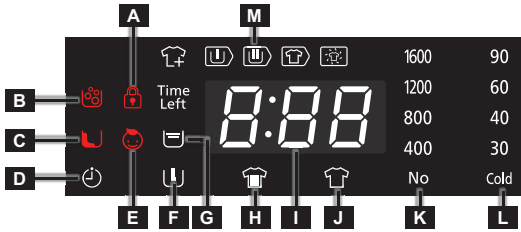





- Directly touch the buttons on the Control Panel with your bare finger.
- If you find water drops, detergent or other foreign substances on the Door Glass, please clean them up with a dry cloth.



<p>1 Power On/Off button</p>	<p>Press and hold this button 1 sec to switch power on and off. If no program is selected or no button is pressed for 20 minutes, the washing machine automatically switches itself off.</p> <p>(For model : BD-120XGV/BD-100XGV. In the case of selecting the unit to be in the remote status If no program is selected or no button is pressed for 23 hours, the washing machine automatically switches itself off.)</p>
<p>2 Start/Pause button</p>	<p>Press this button to start or pause a program. When the machine is paused for over 1 hour, the washing machine automatically switches itself off.</p>
<p>3 Program button</p>	<p>Press this button to select the program.</p>
<p>4 Timer button</p>	<p>Let you program a wash in advance sine 2 to 24 hours later. The ⌚ symbol is shown on the display.</p>
<p>5 Prewash button</p> <div data-bbox="78 1053 330 1093" style="border: 1px solid black; padding: 5px; margin-top: 10px;"> <p>Child Lock (Hold3s)</p> </div>	<p>Prewashes heavily soiled items before the main wash. The  symbol is shown on the display. Pour the powdered detergent into the dispenser .</p> <p>* This unit cannot be used Prewash program if the Auto dosing function is not enabled. (For model BD-120XGV/BD-100XGV)</p> <div data-bbox="352 1125 1047 1236" style="border: 1px solid black; padding: 10px; margin-top: 10px;"> <p>Child lock: To prevent accidental operation by children, this disables the operation buttons, and also locks the door. Press the Prewash button for 3 seconds to activate this option. The  symbol is shown on the display. Press Prewash button for 3 seconds again to cancel the child lock.</p> </div>
<p>6 Intensive button</p>	<p>Extends the washing time for more thorough washing. The  symbol is shown on the display.</p>
<p>7 Rinse Count button</p> <div data-bbox="78 1372 330 1412" style="border: 1px solid black; padding: 5px; margin-top: 10px;"> <p>Rinse Hold (Hold3s)</p> </div>	<p>Can increase and decrease the number of rinses for washing. While you press this button, the number of rinses and the  symbol is shown on the display.</p> <div data-bbox="352 1380 1047 1508" style="border: 1px solid black; padding: 10px; margin-top: 10px;"> <p>Rinse Hold : Laundry remains in the last rinse water without progressing to the final spin cycle to prevent the clothes from wrinkling. Press the Rinse Count button for 3 seconds to activate this option. The  symbol is shown on the display.</p> <p>To unload, select the Spin program from the Special Program and set the spin speed to No spin(No), the machine will only drain the water.</p> </div>

8 Spin button	Enables spin speed setting from No Spin(No) to a maximum speed of 1600 rpm. • No spin(No): Spin is cancelled, and the water is drained out only. Recommended for delicate fabrics.
9 Water Temp. button	Enables temperature setting from cold up to 90°C. When you select cold, the (Cold) symbol is shown on the display and the heater switches off.
10 Memory button	Allows you to store a customized wash cycle which you use frequently. The  symbol is shown on the display.
11 Auto Self Clean button	Automatically cleans the outside of the tub and the inside of the outer tub to keep the washing machine clean. The setting is switched off at the time of shipment from the factory. Once it is switched on, the  symbol is shown on the display. And the Auto Self Clean function operates every time you do your laundry.
12 LED Multifunction display	<p>Displays all cycle information, remaining time and error codes.</p>  <p>The diagram shows a digital display with 'Time Left' and '8:88' shown. Above the display are icons for Door Lock (A), Excessive foam (B), Imbalance (C), Child Lock (E), Prewash (F), Rinse Hold (G), Intensive (H), Remaining time (I), Rinse Count (J), Spin speed (K), and Cold (L). Below the display are icons for Door Lock (A), Excessive foam (B), Imbalance (C), Child Lock (E), Prewash (F), Rinse Hold (G), Intensive (H), Remaining time (I), Rinse Count (J), Spin speed (K), and Cold (L).</p> <p>A Door lock. The door is locked when the  symbol is on or blinks.</p> <p>B Excessive foam in the drum. Washing time is prolonged due to the washing machine will be pouring in extra water to remove excessive foam. *This is not a malfunction. Remaining time may be turned back when The  symbol is shown on the display so that operation is completed in a longer time than the remaining time displayed at the start.</p> <p>C Imbalance in the drum. Washing time is prolonged due to the washing machine will be correcting imbalance by rotating the drum. *This is not a malfunction. Remaining time may be turned back when The  symbol is shown on the display so that operation is completed in a longer time than the remaining time displayed at the start.</p> <p>D Timer option.</p> <p>E Child Lock option. All buttons are disabled except the Power On/Off button and the door is locked when the  symbol is on.</p> <p>F Prewash option.</p> <p>G Rinse Hold option. Final spin is cancelled and water is not drained, so the laundry remains in the last rinse water.</p> <p>H Intensive option.</p> <p>I Remaining time of the program (shows 'Time Left'), remaining time until timer operation is completed (shows 'h'), and error codes. (Page 65 : Error Codes)</p> <p>J Rinse Count option.</p> <p>K Spin speed. No spin(No) : Spin is cancelled and rinsed water is drained in Rinse process only.</p> <p>L Cold.</p>

Control Panel and Display (Continue)

	<p>L Water temperature. The (Cold) symbol is on when the heater is off (Cold setting).</p> <p>M Progress indicator. Shows which phase of the program is operating. The following symbols blink while each phase is running, and go off as each phase ends.</p> <p> Prewash.</p> <p> Main Wash.</p> <p> Rinse.</p> <p> Spin.</p>
<p>13 Fabric Softener button</p> <p>For model : BD-120XGV BD-100XGV</p> 	<p>Press this button when want to put fabric softener into tub automatically during washing process. This function cannot operate in the Tub Wash, Hot Tub Wash, and Spin.</p> <p>When you want to change the input amount → page 34</p>
<p>14 Liquid Detergent button</p> <p>For model : BD-120XGV BD-100XGV</p> 	<p>Press this button when want to put liquid detergent into tub automatically during washing process. This function cannot operate in the Tub Wash, Hot Tub Wash, and Spin.</p> <p>When you want to change the input amount → page 34</p>
<p>15 Remote button</p> <p>For model : BD-120XGV BD-100XGV</p> 	<p>Press this button when you want to operate the washing machine from a smartphone application.</p>
<p>16 Reload</p> 	<p>*You can add fabric when the  symbol is shown on the display. Available before the water become high level and the temperature up to 55°C</p>

Use with smartphones

About the App function

■ What is App functionality?

By pairing this product with your smartphone, you can control and check your washing machine's status from your smartphone.

Pairing is done once and does not need to be repeated every time you use the machine.

- Concierge function to support operation settings
 - After selecting the type of clothes and daily activities involved, such as sports and gardening, the system will guide you to the recommended program.
 - You can set up and run the operation from the list of programs.
You can make a reservation for a program or download a program.
- Notification settings for notifications on the go and at home.
Notifications are sent to your smartphone when the unit is finished running or when it is time to clean the tub.
- Remote function for checking operation status
You can check the operation status and change the scheduled end time of the scheduled operation from a distance.
- Support function for viewing operating instructions
If you are unsure how to operate your washing machine, you can view the instruction manual.
- Update the washing machine's software to the latest version.

■ Environment requirements

Internet Connection

You will need to sign up for an always-on broadband connection with your provider (internet service provider). Dial-up and smartphone tethering are not available.

There is a wireless LAN router installed.

- Please use a wireless LAN router that can be configured for encryption methods WPA2 or WPA (both TKIP or AES).
- The router must be compatible with either IEEE802.11b/g/n (2.4GHz band only).
We do not support the 5GHz band communication standard.
- Mobile routers are not guaranteed to work.

Have a compatible smartphone.

- Please use an Android or iOS (iPhone) smartphone.
Smartphones that do not support the wireless LAN function cannot be used.
Tablet devices are not guaranteed to work.

Please check the following website or the code on the right for compatible OS versions.

<https://www.homeappliances.hitachi.com/global/app/wash/series02/>



Connection diagram

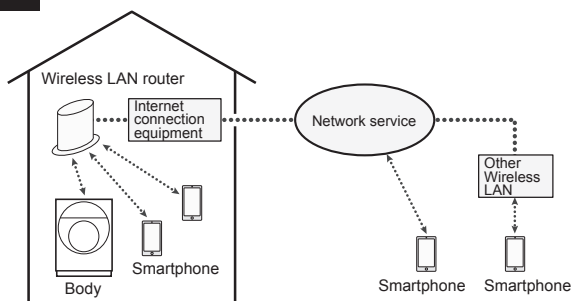

- Please Note: You are responsible for the communication costs required to connect to the Internet, download applications, and operate the product from your smartphone.
- If no communication between the product and the wireless LAN router is established, the product will be "unconnected", and you will be unable to operate the machine from your smartphone.
Take caution when moving the washing machine or the wireless LAN router.
- Up to five smartphones can control one washing machine. Immediately after another person has operated the machine, it will be temporarily inactive.

Use with smartphones (Continue)

NOTICE

- The following illustration is an example of a display. The display screen is subject to change as the application is updated.

1. Install the application on your smartphone.

Install the **Hitachi Washer** application.
(hereinafter Dedicated the "Application")



Hitachi Washer

Android
Open "Google Play"

iPhone
Open "App Store"

You can install the application from the website below.

<https://www.homeappliances.hitachi.com/global/app/wash/series02/>



The application is free of charge, but you will be charged for downloading and using the application. The communication costs are the responsibility of the subscriber of the smartphone used. For instructions on how to install the application, please refer to your smartphone's user manual.

2. Open the application and read the "Terms of Use" carefully.

After installing the application successfully. Open the application and read the 'Terms of Use' carefully, then click to accept the terms of use.

Step 1
Read the "Terms of use" carefully.

Step 2
If you accept the terms of use. Tap the square to mark it.

Step 3
Tap "Next".

The screenshot shows a 'Terms of use' screen with a 'Please select your area.' section listing Thailand, Hong Kong, and Singapore. Below is a Thai text block and a 'Next' button.

3. Register a new member and log in.

Register a new member and login to use the application.

Step 1
Tap "Sign up".

Step 2
Enter your email, set a password and confirm it.

Step 3
Select a country or region.

Step 4
Tap "Confirm".

Step 5
Check registration information. Tap "Send" An email verification code will then be sent to your email address.

The process is shown in three screens: 1. Login/Sign up screen with 'Sign up' button. 2. 'Enter Registration Information' screen with fields for email, password, and country. 3. 'Confirmation of registration information' screen with a 'Send' button.

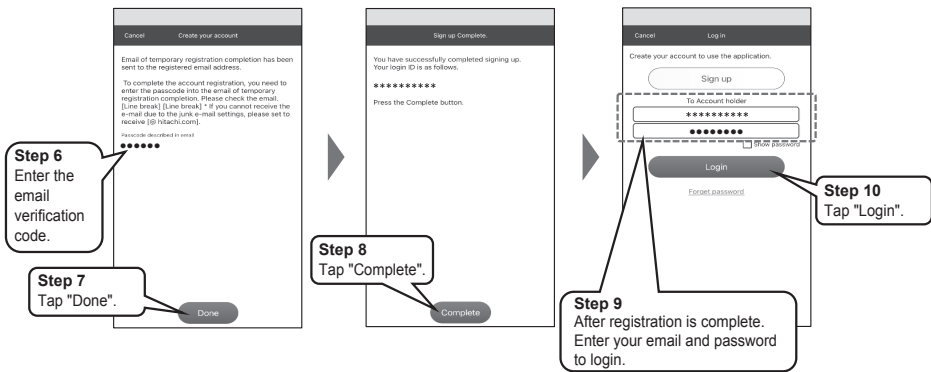

4. Connect your smartphone to a wireless LAN router.

From the application screen, go to the Wi-Fi settings screen on your smartphone and connect your smartphone to the wireless LAN router.

- The operation and setting screen on your smartphone may vary depending on the model and operating system.
- Make sure that the SSID of the wireless router you select in the Wi-Fi settings on your smartphone is in the 2.4GHz band.
- Choose a wireless LAN router connected to the place where the washing machine is installed.
- The SSID of your wireless LAN router is the name that appears in the Wi-Fi settings of your smartphone.
- If you do not know the SSID and password of your wireless LAN router (depending on your wireless LAN router, it may be written as "encryption key" or "security key"). Please refer to the instruction manual of the wireless LAN.

Wi-Fi setting screen on smartphone.

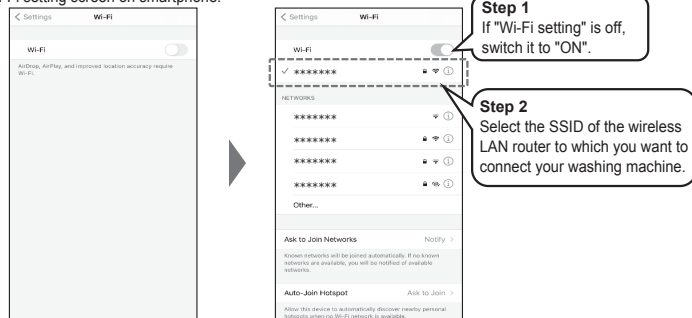

5. Proceed to connect (pairing) the washing machine to your smartphone.

There are 2 ways to connect (pairing) the washing machine to your smartphone:

- Simple connection → (page 22 - 23).
- Manual connection → (page 24-25).

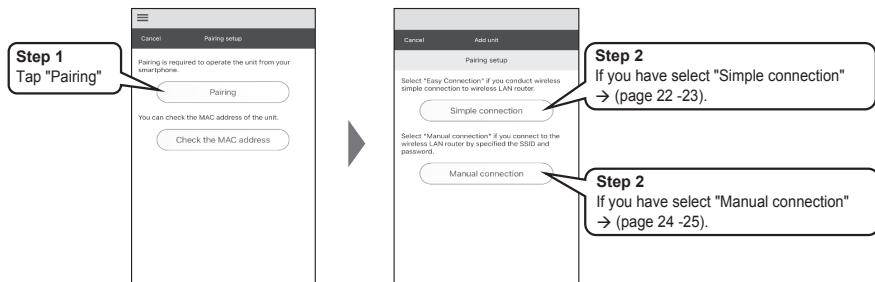

When pairing fails. → (page 58).

Use with smartphones (Continue)

Connecting (pairing) with your smartphone.

Simple connection





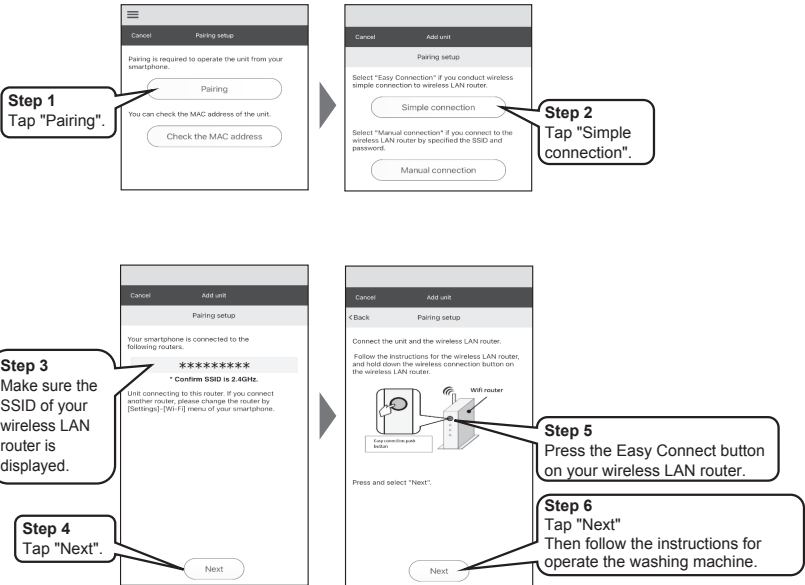

NOTICE

- The following illustration is an example of a display. The display screen is subject to change as the application is updated.

- 1 Operate the application on the smartphone.**
Check the wireless LAN router to which your smartphone is connected to. Follow the on-screen instructions to make sure your router is connected.



- 2 Operate the washing machine.**

- 1 Press**  **to turn on the power.**
- 2 Press**  **and hold for more than 3 seconds.**
 - There will be 3 digits illuminate in the remaining time display Ex) .
- 3 Press**  **1 time.**
 -  will illuminate in the remaining time display.
- 4 Press**  **1 time.**
 -  will blink.

*You cannot enter pairing mode while the communication lamp  is blinking, as it is preparing for communication.

Please wait until the lamp on or off.

3

Operate the application on the smartphone.

Please wait a moment while the pairing process is completed. Follow the on-screen instructions to set the name of the unit and the user name.

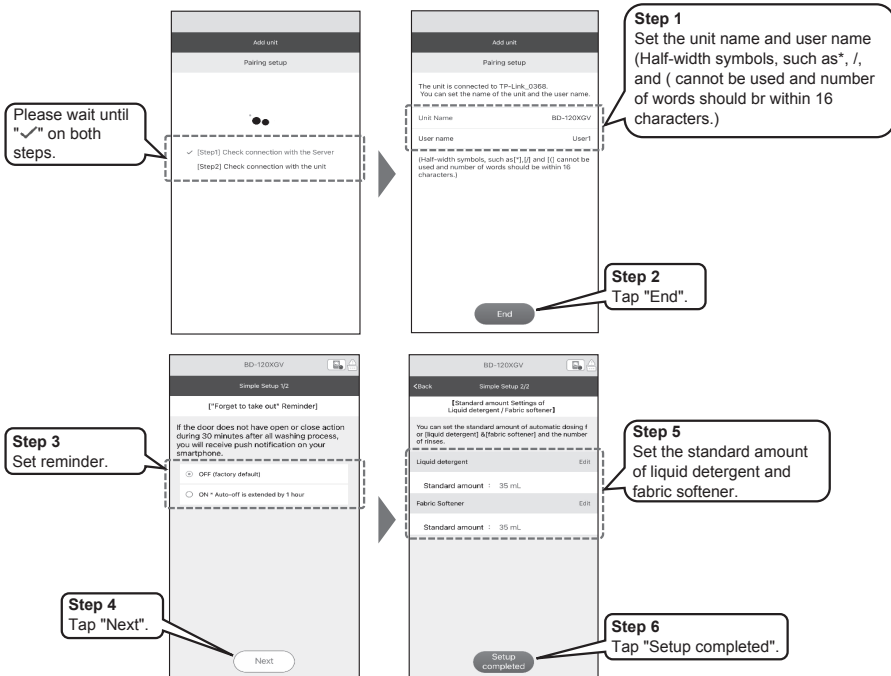

The "Simple connection" setup is complete.

Use with smartphones (Continue)

Connecting (pairing) with your smartphone.

Manual connection

NOTICE

- The following illustration is an example of a display. The display screen is subject to change as the application is updated.

- Operate the application on the smartphone.**
Ensure that your smartphone is connected to the wireless LAN router to which the washing machine is connected to.

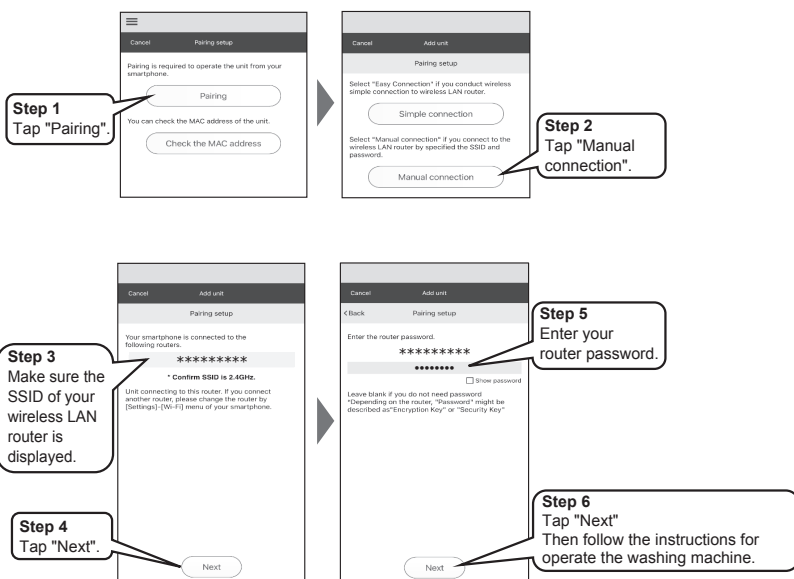

2 Operate the washing machine.

- 1** Press  to turn on the power.

- 2** Press  and hold for more than 3 seconds.

- There will be 3 digits illuminate in the remaining time display Ex) .

- 3** Press  2 times.

-  will illuminate in the remaining time display.

- 4** Press .

-  will blink.

*You cannot enter pairing mode while the communication lamp  is blinking, as it is preparing for communication.

Please wait until the lamp on or off.

3

Operate the application on the smartphone.

Follow the on-screen instructions to connect your smartphone to the washing machine.

When the following screen is displayed in the application, go to the Wi-Fi setting screen of your smartphone and select the SSID of the washing machine (Example : Model name_*****).

- The operation and setting screen on your smartphone may vary depending on the model and operating system.
- It may take a while until the SSID of the washing machine itself "Model name_*****" is displayed.

If it does not appear, please turn off the Wi-Fi setting on your smartphone and then turn it back on.

Step 1
Exit the application and go to the Wi-Fi setting screen of your smartphone.

Wi-Fi setting screen on smartphone.

Step 2
Select the SSID of the washing machine (Model name_*****) then return to the application.

4

Operate the application on the smartphone.

Please wait a moment while the pairing process is completed. Follow the on-screen instructions to set the name of the unit and the user name.

Please wait until "✓" all 4 steps are marked.

Step 1
Set the unit name and user name (Half-width symbols, such as *, /, and (cannot be used and number of words should be within 16 characters.)

Step 2
Tap "End".

Step 3
Set reminder.

Step 4
Tap "Next".

Step 5
Set the standard amount of liquid detergent and fabric softener.

Step 6
Tap "Setup completed".

The "Manual connection" setup is complete.

Before You Start Washing

Preparation of the washing

- Remove any foreign objects (coins, safety pins, etc.).
 - Use a washing net when you wash delicate clothes (knit products, lingerie, etc.).
 - Zip up and brush sand out of pockets and collars.
 - Brush pet hair out of laundries.
-

Sorting of the laundry



- Sort the laundry according to the type of fabric and care label symbol (cottons, mixed fibers, synthetics, wool, hand wash, etc.).
- Do not wash too small amount of laundry such as only a pair of jeans.
→ This may result in insufficient spin performance.
- Separate colored and white items.

Risk of injury!

Washing the following items may cause injury or malfunction due to abnormal vibration :

- Waterproof items such as a wet suit, ski suit, etc.
 - Anti-slip treated items with rubber bottoms such as a doormat.
 - Cushions, pillows, shoes, etc.
-

Detergents and additives

- Use the amount of detergent recommended on the detergent package. The type and amount of detergent depends on the type of fabric, load size, degree of soiling and hardness of the water used.
Use less detergent if :
 - you wash a small load.
 - the laundry is slightly soiled.
 - Too much detergent can result in excess foam formation which reduces rinse efficiency or may cause a water leak.
 - Depending on the detergent brand, detergent may remain undissolved when the water pressure is low, or when the water temperature is low.
→ Page 53 : Care and Maintenance (Cleaning the detergent dispenser).
 - Do not use liquid detergent input Dispenser Main Wash when using the Prewash option. (For model BD-120GV/BD-100GV)
 - If use Prewash program. Please on Auto dosing function, Washing machine will appropriate input amount is automatically (For model BD-120XGV/BD-100XGV)
 - The detergent and any additives must be poured into the appropriate dispenser.
→ Page 3 : Parts and Accessories (Detergent Dispenser).
 - Pour in the detergent before you press the Start/Pause button. If you add the Prewash option, pour detergent into both dispensers () before starting.
 - For bleaching, use bleaches that are suitable for washing machines.
 - For water softener and limescale removal agents, follow the instructions on the package.
 - For using laundry detergent and fabric softener When using the function Auto dosing
→ Page 33 : How to put the detergent and softener
-

Washing with different degrees of soiling

- Lightly to normally soiled : No washing options (Prewash/Intensive) are necessary for more eco-friendly operation.
- Normally to heavily soiled : Select Intensive as an option for better washing results.
- Heavily soiled : Select Prewash as an option for better washing results.

How to Use the Washing Machine



1 Sort and load the laundry

- Sort the laundry according to type of fabric, care label symbol, color and degree of soiling.
→ Page 26 : Preparation of the washing.
- Do not exceed the maximum load.
- Close the door. Take care not to trap any items of clothing between the door and rubber seal.

2 Press the Power On/Off button to switch power on

- If no program is selected is pressed for 20 minutes, the washing machine automatically switches itself off. Press the Power On/Off button again to turn power on.

3 Select and adjust the program

- Select a program with the Program button.
- The duration of the selected program is shown on the display as a guide. Actual washing time may vary depending on the conditions.
- Use the option buttons to set additional functions.
→ Page 16 : Control Panel and Display.
→ Page 36 : Program Overview.
- If you select the wrong program by mistake, reselect the washing program.

4 Add detergent into the detergent dispenser

- The detergent and any additives must be filled into the dispenser correctly.
→ Page 33 : How to put the detergent and softener

How to Use the Washing Machine (Continue)

5

Press the Start/Pause button

- The washing machine starts to detect laundry amount, before setting the wash time.
- The wash time displayed on the remaining time indicator varies according to the conditions.
→ Page 16 : Control Panel and Display.
- Once a program starts, settings cannot be changed except for the spin speed setting of programs other than the Duvet/Spin/Tub Wash/Rinse & Spin/Wool(*)/Hot Tub Wash(*)/Outdoor(*) programs.
* Download program for BD-120XGV/BD-100XGV.

Pausing a program.	Press the Start/Pause button. The washing machine switches itself off if it is not restarted within 1 hour. Switch the power on and the program starts again from the beginning.
Adding clothes part way through a wash.	<p>*You can add fabric when the  symbol is shown on the display. Available before the water become high level and the temperature up to 55°C</p> <p>Press the Start/Pause button to pause the selected program. The door lock is automatically released after about 5 seconds when the water level and temperature are safe. You can then open the door and add your clothes. Close the door and press the Start/Pause button again to restart the program.</p> <p>*Note: It is not recommended to add a large amount of clothes as the washing machine first measures the load size to determine optimum operation.</p>
Terminating a program.	Press the Start/Pause button, and press the Power On/Off button to switch power off. Then press the Power On/Off button again and select the Spin program to drain remaining water in the drum and spin-dry the laundry.

6

Program ends

- The buzzer sounds when the program ends.

By pressing the Special Program button for 3 seconds, (After press Power On/Off button) There is a reception sound and if you press and setting will be set. Setup until you get the sound you want.

- The washing machine automatically switches itself off when the program ends.

Control your Washing Machine with your Smartphone

To remotely control your washing machine from your smartphone, please follow the steps below. If pairing has not been completed, the machine cannot be set to remote control standby. → (P.61)

Put the remote control in standby

1 Operation of the washing machine

Close the door.

Press  to switch on

「」 Wait for the communication lamp to light up.

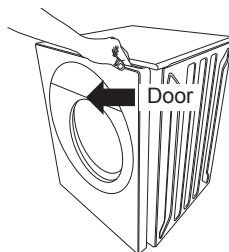

Please wait while the light is flashing as it is preparing for communication.

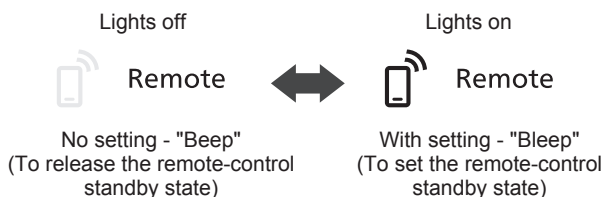

2 Press

Each press changes the display and allows you to make changes. The display and sound indicate when the setting is complete.



- When the remote-control standby mode is set, 「」 (Symbolic "Door lock") lights up to prevent the door or lid from being opened and the door or lid is locked.
- When the communication lamp is flashing, the remote-control standby mode cannot be set because 「」 communication is being prepared.
- The remote-control standby mode is automatically released when the power is switched off or the operation is finished.
- When the remote-control standby mode is set, the power is automatically turned off after 23 hours of inactivity.

How to View the App

NOTICE

- The following illustration is an example of a display. The display screen is subject to change as the application is updated.

How to view the initial screen

The screen display and other information in the application may change as the application is updated. For detailed instructions, please refer to the in-App instructions.

"Menu" button

"Menu" button Tap to bring up the menu, where you can change or check your settings.

- Included is: connection settings, notifications, version information, terms of use, copyright information and logout.

Name of the Washing Machine

The name of the connected washing machine is displayed. The name of the washing machine can be changed using the "Menu" button.

Status of the Unit

The status of the unit is displayed. If you tap the button while the announcement is being displayed, the details of the notification will be displayed.



Notice displays



There is a "notification display".



There is no "Notification display".

"Select function" button

By selecting the icon for each function, you can switch between Top Page, Concierge, Status check, Support and Set.

- **Top Page**

Displays Favorite program used programs.

- **Concierge**

You can set up and run a program from the program list. You can also make a reservation for a program or download a program.

- **Status Check**

You can check the operating status of your washing machine from your smartphone.

- **Support**

You can view instruction manual, About wireless LAN function, How to maintenance, Announcement display and Contact us

- **Setting**

Changing the notification setting, Liquid Detergent/Fabric Softener Standard amount Setting, Convenient Usage and History List.

When the "NEW" symbol appears in the App version information

When the "NEW" symbol is displayed in the version information of the application, you can update the washing machine's software.

- The update cannot be carried out when the power is off, during operation or during a reservation.
- If you update the software or application, the contents of the update may differ from those described in this manual.
- The update will take approximately 10 to 15 minutes.
- During the update, you cannot operate the machine.

During the update, the bar on the remaining time display of the washing machine will turn round and round.

Depending on the update's content, the display may turn off and then turn around and around again.

When the update is finished, the display will automatically turn off, and the machine will return to standby mode.

- Please do not turn off the power while updating.

This may result in the washing machine not turning on, not being able to run, or not being able to operate from a smartphone.



Software Updating

Updating the washing machine's software

NOTICE

- The following illustration is an example of a display. The display screen is subject to change as the application is updated.

1

Operation of the washing machine

Press  to turn it on

Please make sure that the "Wireless LAN function setting" of the washing machine is set to "On (The wireless LAN function)"
→ Page 44 : Setting of the wireless LAN function.

2

Smartphone (App) operation

Step 1
Tap the "Menu"
button.



3

Smartphone (App) operation

Step 2
Tap on "Version
Information".

"NEW" will be
displayed.

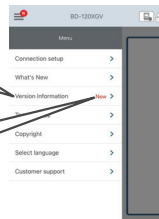

Step 3
Select "Unit Version".



4

Smartphone (App) operation

Step 4
Select "Update the
software".

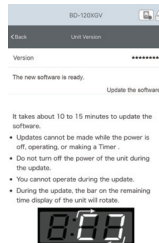

If "This is the latest software" is displayed, you do not need to update your software.

- If the power is cut off during an update due to a power failure:

(1) Ensure that the power has been restored after the power failure, then turn on the power by pressing the  button.

(2) Please wait for about 10 seconds without operating the washing machine or the application.

If the display does not change to "Updating", the update has been completed successfully, and you can use the washing machine. If the display changes automatically to the updating display: Do not disconnect the power supply plug until the updating is finished.

Checking the MAC address

NOTICE

- The following illustration is an example of a display. The display screen is subject to change as the application is updated.

You can check the MAC address of your washing machine in two different ways.

If pairing has not been completed

You can find the MAC address of washing machines that have not been paired follow the steps below. Please follow the on-screen instructions.

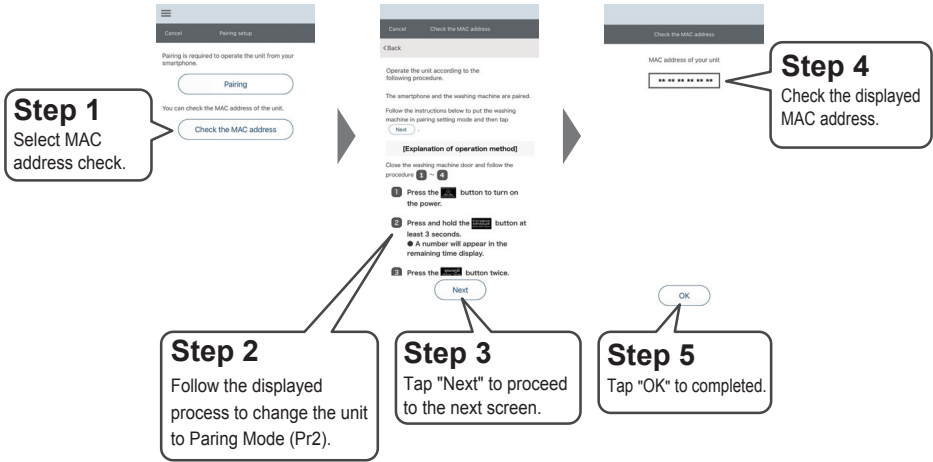

If paring has already taken place

You can find the MAC addresses of a washing machine that has been paired follow the steps below.

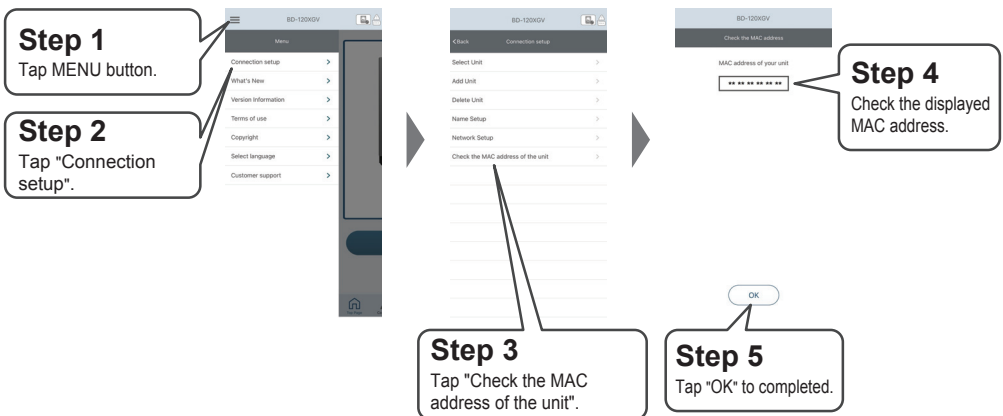

How to put the detergent and softener

For BD-120XGV/BD-100XGV

Automatic Loading Section

Pull out the liquid detergent/fabric softener Dispenser

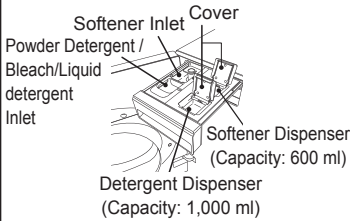

What to put in the automatic section

• Liquid detergent

If you want to add powdered detergent or liquid detergent, please deactivate the automatic loading setting

• Softener

If you want to add fabric softener, please deactivate the automatic loading setting

What to put in the manual section

- Powder detergent
- Liquid detergent
- Liquid soap
- Softener
- Oxygen Bleach

Put it in bleach along with powder detergent in the detergent dispenser.

Note.

Do not add powder detergent, or bleach to the automatic input dispensers.

Check the liquid level scale with the liquid detergent and fabric softener dispensers installed in the machine and make sure that the liquid level does not exceed the level indicated by the "Max." sign.

For BD-120GV/BD-100GV

Manual Loading Section

Pull out the powder detergent/fabric softener Dispenser

Powder Detergent/Bleach/Liquid detergent Inlet (for Main Wash program)

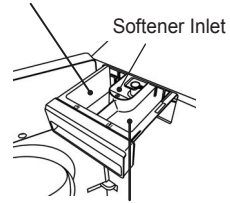

Powder Detergent/Bleach/Liquid detergent Inlet (for Prewash function)

What to put in the manual section

- Powder detergent
 - Liquid detergent
 - Liquid soap
 - Softener
 - Oxygen Bleach
- Put it in bleach along with powder detergent in the detergent dispenser.

Things to put directly into the drum

- Gel ball detergent
- Laundry beads
- Detergents in tablet, sheet, and cube forms

Items that cannot be used in a washing machine

- **Baking soda, otherwise it may cause malfunction.**
- **Soap powder (natural oils and fats)**

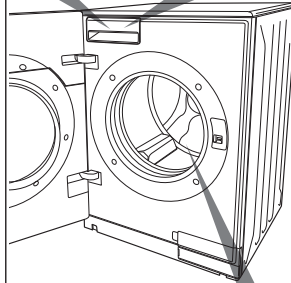

- If the liquid detergent-softener dispenser still contains deteriorated detergent-softener ingredients, there is a risk of blockages in the pathways.
- Do not use highly viscous detergents/softeners or those that have solidified or separated into a jelly-like material.
- If the machine will not be used for a long period of time, it should be cleaned. Otherwise, mildew may occur. → (P.53, 57)
- Condensation may occur in the manual loading section even when the automatic feeder is in use, as water flows through it. This is not a malfunction. If you are concerned about this, please clean it. → (P.53)

How to put the detergent and softener (Continue)

The standard amount setting.

It is necessary to set the standard volume (volume used per 30 L of water) according to the liquid detergent or fabric softener used. Liquid detergent and fabric softener cannot be set at the same time.

Procedure

1 Press  to switch on.

2 To set the standard amount of liquid detergent

Press  for at least 5 seconds.

*The standard amount is displayed as shown in the display example. (as per fixture)
At the time of shipment from the factory, the standard amount is set for a water volume of 30 L.
– For liquid detergent 35 mL
– For fabric softener 30 mL

To set the standard amount of fabric softener

Press  for at least 5 seconds.

Ex) 

3 Check and set the “amount used for 30 L of water” written on the container.

The amount can be set from 10 to 80 ml.

To reduce the amount, press .

To increase the amount, press .

Check the recommended amount of liquid detergent or fabric softener to use.



If this information is not available, please contact the detergent manufacturer.

4 Press  to set up.

■ When changing the type of liquid detergent or fabric softener

- Clean the dispenser mounting part of the automatic loading section first.
If different types are mixed together, they can clog the automatic loading section and the channels.
- Change the standard amount setting for liquid detergent or fabric softener.
If you run the machine without setting the standard amount of liquid detergent or fabric softener, the laundry may not be easily cleaned, and it may cause darkening or yellowing. In addition, a large amount of bubbles may be generated, which may cause water leakage or overflow from the drain.

■ How to read the remaining amount of liquid detergent and fabric softener

"Empty" will flash when the liquid detergent or fabric softener in the fabric softener dispenser is low. Refill with liquid detergent or fabric softener.

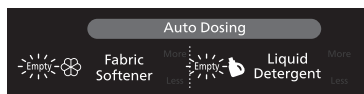

Setting and unsetting automatic loading

Liquid detergent and fabric softener are automatically added every time you wash. You can set the amount of liquid detergent or fabric softener by pressing "More" or "Less".

Procedure

1 Press  to turn on the power.

2 You can select only "Liquid Detergent" or "Fabric Softener".

Depending on the setting, it may be deactivated automatically or may not be accepted.

To set and unset liquid detergent

Press 

The display changes with each press.

Display example

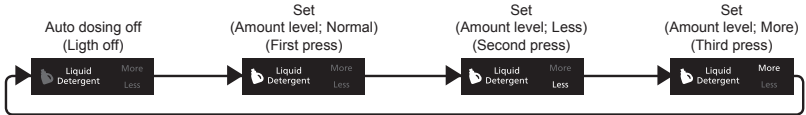

The display changes each time you press

If you selected the AI wash program, you can choose between "No setting" and "With setting" (Detergent amount: standard) for the automatic loading of liquid detergent. "With setting" (more or less detergent) cannot be set as it is adjusted automatically.

To set and unset fabric softener

Press 

The display changes with each press.



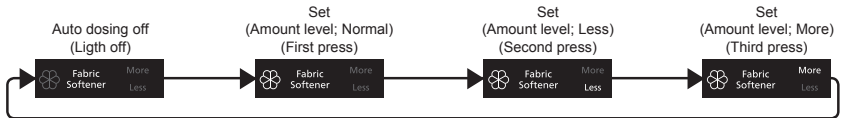



Display example



The display changes each time you press







3 Press  to store the settings.

Program Overview

Program	Type of Laundry / Notes
AI Wash	This is a program for wash your usual laundry.
Cotton	This is a program for your cotton laundry.
Delicate	This is a program for your delicate laundry with symbol  and  .
Rapid 15	This is a program for your lightly soiled laundry in a short time.
60°C Hygiene	This program used when you want to sterilize cotton laundry or when you want to reduce allergens.
Duvet	This is a program for blankets and comforters with symbol  or  .
Stain Care	This program is used to remove and prevent yellowing and stain of your laundry.
Baby Care (*) (For model BD-120XGV/BD-100XGV only)	This is a program for washing the baby clothes.
Crease Care	This program is used when you want to eliminate wrinkles caused by washing.
Daily 38	This program is used when you want to wash in a short time.
Spin	This program is used when dehydrating wet clothing.
Silent	This program is used when you want to wash quietly.
Tub Wash	This program is used when you are worried about dirt and odors on the drum. (Please do not put laundry).
Wool	This is a program for your wool laundry with symbol  and  .
Rinse & Spin (*) (When use BD-120XGV/BD-100XGV Please download the program from the application.)	This program is used to rinse and spin laundry.
Synthetic (*) (For model BD-120XGV/BD-100XGV only)	This program is used when you want to wash synthetic type laundry.
Outdoor (*) (For model BD-120XGV/BD-100XGV only)	This program is used when you want to wash waterproof clothes such as Gore-Tex.
Hot Tub Wash (*) (For model BD-120XGV/BD-100XGV only)	This program is used when you are worried about dirt or odor on the drum. Do not put the washing tub cleaner. Hazardous gas may be generated.

(*) is the download program for model BD-D120XGV/BD-D100XGV, please download the program from the application to use.

Cotton, 60°C, 1200 rpm program cycle is the recommended program cycle for a normal soiled load at the rated capacity.

Model / Max Load		Temperature Setting	Spin Setting	Selectable Options					
BD-120XGV/ BD-120GV	BD-100XGV/ BD-100GV			 Prewash	 Intensive	 Rinse Count	 Rinse Hold	 Timer	 Auto Self Clean
12 kg	10 kg	Cold/30-90°C	400-1600 r/min No Spin	○	○	○	○	○	○
12 kg	10 kg	Cold/30-90°C	400-1600 r/min No Spin	○	○	○	○	○	○
3 kg	3 kg	Cold/ 30°C/40°C	400-800 r/min No Spin	–	–	○	○	○	–
2 kg	2 kg	Cold/30°C	400-1200 r/min No Spin	–	–	–	○	–	–
4 kg	4 kg	Cold/60°C	400-1600 r/min No Spin	○	○	–	–	○	○
3 kg	3 kg	Cold/ 30°C/40°C	1200 r/min No Spin	–	–	–	○	○	–
2 kg	2 kg	40°C	400-1600 r/min	–	–	–	–	○	○
4 kg	4 kg	40°C	400-1200 r/min	–	–	○	○	○	–
4.5 kg	4.5 kg	Cold/30-60°C	400-1200 r/min No Spin	○	○	○	○	○	○
5 kg	5 kg	Cold/30-60°C	400-1600 r/min	○	–	○	–	○	○
12 kg	10 kg	–	400-1600 r/min	–	–	–	–	–	–
4.5 kg	4.5 kg	Cold/30-90°C	400-1200 r/min No Spin	○	○	○	–	○	○
–	–	Cold	1200 r/min	–	–	–	–	–	–
3 kg	3 kg	Cold/30°C	400 r/min No Spin	–	–	–	○	○	–
12 kg	10 kg	–	400-1600 r/min No Spin	–	–	○	○	–	○
4.5 kg	4.5 kg	Cold/30-60°C	400-1600 r/min No Spin	○	○	○	○	○	○
3 kg	3 kg	Cold/30-40°C	800 r/min No Spin	○	○	○	○	○	○
–	–	–	–	–	–	–	–	–	–

How to Use the Washing Machine Program

Using AI Wash

This washing machine consists of multiple sensors to sense various washing conditions and automatically control the washing method and operating time according to the type of detergent, type of clothing, water hardness, and other conditions.

Operation

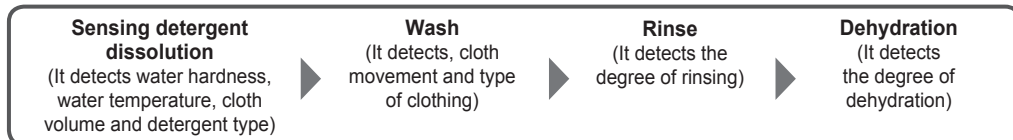

Operation:

1. Open the tap.
2. Put the laundry in the drum, fill detergent/softener and then close the door.
3. Press the Power On/Off button to turn on the power.
4. Select AI Wash program (the indicator light on the program button will flash).
5. Press the Start/Pause button to start operation.

NOTICE

- For models with "Autodosing" function and this function activated, it is not necessary to fill detergent, bleach and fabric softener manually.

Using Cotton Program

Operation:

1. Open the tap.
2. Put the laundry in the drum, fill detergent/softener and then close the door.
3. Press the Power On/Off button to turn on the power.
4. Select Cotton program (the indicator light on the program button will flash).
5. Press the Start/Pause button to start operation.

Using Delicate Program

Operation:

1. Open the tap.
2. Put the laundry in the drum, fill detergent/softener and then close the door.
3. Press the Power On/Off button to turn on the power.
4. Select Delicate program (the indicator light on the program button will flash).
5. Press the Start/Pause button to start operation.

Using Rapid 15 Program

Operation:

1. Open the tap.
2. Put the laundry in the drum, fill detergent/softener and then close the door.
3. Press the Power On/Off button to turn on the power.
4. Select Rapid 15 program (the indicator light on the program button will flash).
5. Press the Start/Pause button to start operation.

Using 60°C Hygiene Program

Operation:

1. Open the tap.
2. Put the laundry in the drum, fill detergent/softener and then close the door.
3. Press the Power On/Off button to turn on the power.
4. Select 60°C Hygiene program (the indicator light on the program button will flash).
5. Press the Start/Pause button to start operation.

Using Duvet Program

NOTICE

- Do not use a laundry net. Otherwise, this will cause a washing machine to vibrate strongly during dehydration.

Operation:

1. Open the tap.
2. Put the laundry in the drum by following these instructions:
 - Fold a large cloth, such as duvet, blanket, as shown in the figure.

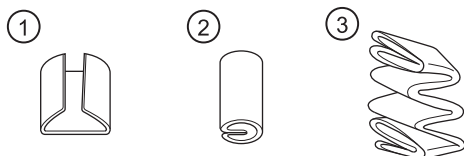

- Place a cloth into the drum by facing both ends of cloth towards the back of the drum

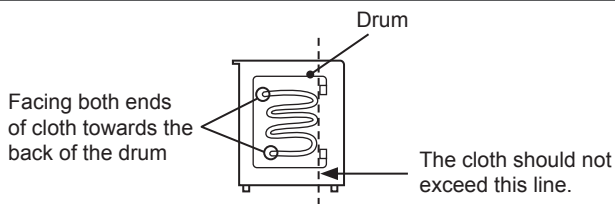

3. Fill detergent/softener and then close the door.
4. Press the Power On/Off button to turn on the power.
5. Select Duvet program (the indicator light on the program button will flash).
6. Press the Start/Pause button to start operation.

Suitable laundry for Duvet program:

- Washable Duvet
 - Do not wash duvet with fleece stuffing or silk cover.
 - Do not wash with other clothes.
- Washable Blanket
 - Do not wash wool, long velvet, electric blanket.

How to Use the Washing Machine Program (Continue)

Using Stain Care Program

Operation:

1. Open the tap.
 2. Put the laundry in the drum, fill detergent/softener and then close the door.
 3. Press the Power On/Off button to turn on the power.
 4. Select Stain Care program (the indicator light on the program button will flash).
 5. Press the Start/Pause button to start operation.
-

Using Wool Program

Operation:

1. Open the tap.
 2. Put the laundry in the drum, fill detergent/softener and then close the door.
 3. Press the Power On/Off button to turn on the power.
 4. Press the Special Program button to select Wool program (the indicator light on the program button will flash).
 5. Press the Start/Pause button to start operation.
-

Using Crease Care Program

Operation:

1. Open the tap.
 2. Put the laundry in the drum, fill detergent/softener and then close the door.
 3. Press the Power On/Off button to turn on the power.
 4. Select Crease Care program (the indicator light on the program button will flash).
 5. Press the Start/Pause button to start operation.
-

Using Daily 38 Program

Operation:

1. Open the tap.
 2. Put the laundry in the drum, fill detergent/softener and then close the door.
 3. Press the Power On/Off button to turn on the power.
 4. Press the Special Program button to select Daily 38 program (the indicator light on the program button will flash).
 5. Press the Start/Pause button to start operation.
-

Using Spin Program

Operation:

1. Put the laundry in the drum and then close the door.
 2. Press the Power On/Off button to turn on the power.
 3. Press the Special Program button to select Spin program (the indicator light on the program button will flash).
 4. Press the Start/Pause button to start operation.
-

Using Silent Program

Operation:

1. Open the tap.
2. Put the laundry in the drum, fill detergent/softener and then close the door.
3. Press the Power On/Off button to turn on the power.
4. Press the Special Program button to select Silent program (the indicator light on the program button will flash).
5. Press the Start/Pause button to start operation.

Using Tub Wash Program

Operation:

1. Open the tap.
 2. Press the Power On/Off button to turn on the power.
 3. Press the Special program to select Tub Wash program (the indicator light on the program button will flash) and then press the Start/Pause button.
 4. The washing machine is filling with water. When the water surface in the drum is seen, press the Start/Pause button again.
 5. Open the door and fill the washing machine tub cleaner or chlorine bleach for laundry, and then close the door.
 6. Press the Start/Pause button to start operation.
-

Using Rinse&Spin Program *BD-120GV/BD-100GV only

Operation:

1. Put the laundry in the drum and then close the door.
 2. Press the Power On/Off button to turn on the power.
 3. Press the Special Program button to select Rinse&Spin program (the indicator light on the program button will flash).
 4. Press the Start/Pause button to start operation.
-

Using Download Program *BD-120XGV/BD-100XGV only

****At the shipment from the factory is set Rinse & Spin program.**

Operation:

1. Open the tap.
2. Put the laundry in the drum and then close the door.
3. Press the Power On/Off button to turn on the power.
4. Press the Special Program button to select Download program (the indicator light on the program button will flash).
5. Press the Start/Pause button to start operation.

How to Use the Washing Machine Program (Continue)

How to use the Auto Self Clean function

1. Press the Power button to turn on the power.
2. Select a program.
3. Press the Auto Self Clean button, and then press the Start/Pause button.
 - The setting is switched off at the time of shipment from the factory. Once it is switched on, the Auto Self Clean function operates every time you do your laundry.
 - Prior to the final spin cycle, the outside of the tub, and the inside of the outer tub are washed to eliminate dirt and mold.
 - To deactivate the Auto Self Clean function, press the Auto Self Clean button again while the power is on.

- The Auto Self Clean function runs just before the spin cycle begins in each program.
- The Auto Self Clean function cannot be set or canceled while the washing machine is operating.
- The Auto Self Clean function is automatically canceled when:
 - Rinse Hold is set.
 - No spinning is set.
- Depending on the type and degree of dirt, some dirt may not be removed by using the Auto Self Clean function.
- If the washing machine is seldom used, some dirt may not be removed by using the Auto Self Clean function.
- To clean the tub more completely, we recommend using the Tub Wash program along with the Auto Self Clean function.

- The Auto Self Clean function is deactivated if one of the following programs is selected.
→ Page 36-37 : Program Overview

How to use the Memory function

1. Press the Power button to turn on the power.
2. Select and adjust the program as desired.
3. Press the Memory button, then the setting is memorized.
4. Press the Start/Pause button.
 - Once the setting is saved, the customized program can be selected with just a press of the Memory button.
 - Customized program can be changed by doing the same procedure.

Convenient Usage

Press [Auto Self Clean] to change the setting.

Auto Self Clean Press this button for more than 3 seconds, the remaining time display will show three numbers, as shown below. The number displayed indicates the respective setting.

If you do not wish to change the setting, press  and switch off the machine.

(Example of display)

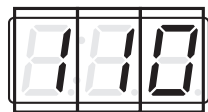

Interior lighting setting. (For model BD-120XGV/BD-100XGV)
(0: 3 hours)

Notification sound settings If you perform an invalid operation.
(1: On)

Setting of the wireless LAN function. (For model BD-120XGV/BD-100XGV)
(1 : On)

Interior lighting setting (For model BD-120XGV/BD-100XGV)



After finishing the washing the lighting inside the tub will be on for 3 hours until the glass door is opened, the laundry is removed and the glass door is closed the lighting will off.

“3 hours” is set at the time of shipment from factory, when you want to change the setting please follow the procedure.

- 1 Press  to turn on the power.
- 2 Press and hold **Auto Self Clean** at least 3 seconds.
 - Numbers are displayed on the remaining time display.

- 3 Press **Spin** to setting.

The display changes each time when you touch it.

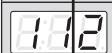
	0 : 3 hours (Default)
	1 : Always lit
	2 : Always off



- 4 Press  to complete the setting.

The changed contents are remembered even when the power is turned off. To change the setting, do the same operation.



Convenient Usage (Continue)

Notification sound settings If you perform an invalid operation

If you perform an invalid operation other than the power [Power On/Off] and [Start/Pause] buttons, you will be notified with a beeping sound.

- 1 Press  to turn on the power.
- 2 Press and hold  at least 3 seconds.
 - Numbers are displayed on the remaining time display.

- 3 Press  to setting.
The display changes each time when you touch it.

	0 : Off
	1 : On (Factory Default)



- 4 Press  to complete the setting.

The changed contents are remembered even when the power is turned off. To change the setting, do the same operation.

Setting of the wireless LAN function (For model BD-120XGV/BD-100XGV)

You can switch between [Off/On] for the wireless LAN function.
When the wireless LAN function is set to [Off], you cannot set the pairing or operate or check the status from a smartphone.

※ Cannot be set when  on the washing machine is off or blinking.

- 1 Press  to turn on the power.
- 2 Press and hold  at least 3 seconds.
 - Numbers are displayed on the remaining time display.
 - ※ Wait until the communication lamp  lights up.
Please wait while the light is flashing as it is preparing for communication.

- 3 Press  to setting.
The display changes each time when you touch it.

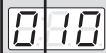
	1 : On (The wireless LAN function) (Factory Default)
	0 : Off (The wireless LAN function)

- 4 Press  to complete the setting.

The changed contents are remembered even when the power is turned off. To change the setting, do the same operation.

When disposing or transferring the washing machine

You must erase all registered information to default setting.

1 Press  to turn on the power.

2 Press and hold  at least 3 seconds.

- Numbers are displayed on the remaining time display.

3 Press  3 times.

 Is displayed on the remaining time display.

4 If you press  the display of  disappears and the setting is deleted.

5 Press  to turn off the power.

※ If you delete (initialize) all the registered information when the washing machine is not connected to the wireless LAN router, the settings of the dedicated application will remain.

You must also delete the unit from the application. by opening the application → Menu  → Connection setup → Delete Unit → Select the unit you want to delete from the application.

In Case of Emergency

In the event of a power outage.

The washing machine features a Fully Auto Restart function.

If the power is shut off part way through a wash, the cycle (wash/rinse/spin) at the time is memorized, and when power is restored, the same cycle automatically restarts from the beginning.

Emergency door release.

If the laundry has to be removed in the event of an extended power outage, or in the event of malfunction of the door lock, the washing machine door can be opened as follows.

1

Press  to turn off the power and disconnect the mains plug.

When the power is on in the event of malfunction of the door lock.



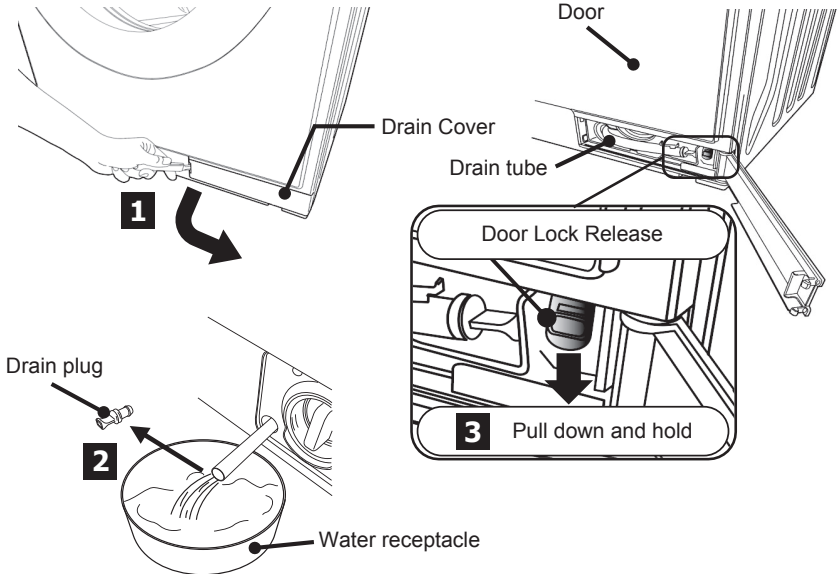

2

Open the Drain Cover.

- 1** Insert a thin/slim object such as a flat-blade screwdriver or a handle of spoon/fork into the slot of the Drain Cover to open it.
- 2** Pull out the drain tube and remove the drain plug to drain the water.
- 3** Pull the "Door Lock Release" downwards. Then you can open the Door of the washing machine.



• If a lot of water remain in the drum, operate as follows.

- 1** Press  to turn on the power.
- 2** Press  to select the spin program .
- 3** Press  to start.

Care and Maintenance

Care and Maintenance for the machine and drum.

If the drum is soiled or covered with water droplets, please clean it.

- Ingre dients in water and detergent may adhere to the surface of the drum and oxidize, causing discoloration.

If this is a concern, wipe off with a special stainless-steel cleaner.

- If there is water droplets or dirt on the main machine or detergent or fabric softener accumulate on plastic parts such as the door, or on metal parts, wipe it off with a soft cloth.
If left unattended, it may cause damage (such as peeling of the display), rusting or breakage.
- If the glass surface on the inside of the door becomes dirty, wipe it with a damp cloth.
- Do not use benzine, thinner, cleanser, alkaline detergent, mild alkaline detergent, wax, etc., or scrub with a scrubber.
- Rust on the drum should be wiped off with a cleanser.
Do not use a metal scrubber.
- Stainless steel drums are rust resistant quality, but rust can occur in the following cases:
 - Prolonged contact of hairpins or other objects with the drum, or the use of water contaminated with iron dust or red rust.
 - Leaving chlorine bleach, detergent or fabric softener in the drum for a long period of time.
- At the end of operation, water may drip from the water inlet into the water supply channel, wipe it off with a soft cloth.
- If you are concerned about dirt and odor in the drum, operate the [Tub Wash] or [Hot Tub Wash] (For model BD-120XGV/BD-100XGV) programs.
 - If you want to operate [Hot Tub Wash] please download from the application to use.
- Wipe off drain around the door, around the bellow, on the back side, and inside the drum with a soft cloth each time.

Drain may stick between the bellow and the door, causing water leakage or drain adhering to the laundry.

- If drain still sticks to the laundry even after wiping it off, run the [Tub Wash (2 or 10 hours)] program.

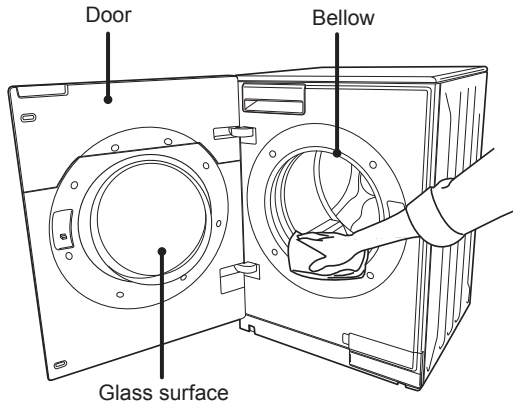

- Depending on the environmental conditions, there may be condensation on the door and around the door bellow, which can be wiped off if you are concerned.
- When cleaning the area around the door bellow, do not hang the cloth on the packing. This may deform the door seals and cause water leakage.

Care and Maintenance (Continue)

Care and Maintenance of the Tap water supply.





If the tap water supply time becomes too long or [C01] appears on the display, please take care of it. To prevent water splashing, please follow these steps:

1 Close the tap.

Close



2 Drain the water in the water supply hose.

- 1 Press  to turn on the power.
- 2 Select the "Rapid 15" program.
※ This is because the water supply operation starts immediately.
- 3 Press  and let it run for about 10 seconds.
The residual water in the water supply hose enters the drum.
- 4 Press  to pause operation.
- 5 Press  to turn off the power.

3 Turn the union nut in the direction of the arrow and disconnect the water supply hose.

Residual water in the water supply hose may drip. Place a container such as a bucket at the end of the water supply hose, or use a cloth to catch the water.

Union nut

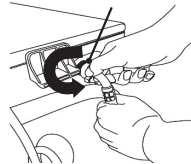

4 Remove any debris from the water inlet filter with a toothbrush.

Remove the water inlet filter with pliers and clean it. Do not forget to put the filter back in place after cleaning. Failure to install it may cause the water supply valve to malfunction.

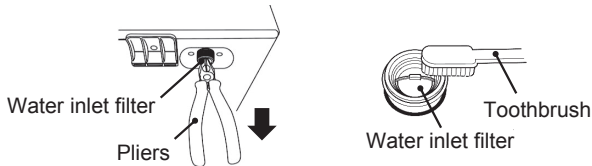

5 Attach the water supply hose to the water inlet.

Tighten the union nut securely. If it is loose, it may cause water leakage.

6 Open the tap.

Open



Clean with Hot Tub Wash (*) / Tub Wash program.

This program is recommended when you are concerned about the dirt and smell of the drums.

How to use the program properly.

Program	Operating time	In a case like this	Washing tub cleaner to be used
Hot Tub Wash (*)	2 hours	When the drum is dirty or smelly. This operation is recommended when the drum or the laundry is dirty, or when there is an odor in the drum. If you want to clean the drum in a short time, we recommend the [Hot Tub Wash] program. The Hot Tub Wash program consumes more power than the 10-hour program.	Liquid peroxide – based bleach (Please follow the instructions given on its package)
Tub Wash	10 hours		
	2 hours	When you want to reduce the smell of the drum. Use of this operation on a regular basis is recommended. <ul style="list-style-type: none"> Once every 3 to 4 months if you are using the [Auto Self clean] function. Once every 1-2 months if you are not using [Auto Self clean] continuously. 	

Please do not put clothes in the drum while using this program.



*If you want to operate [Hot Tub Wash] please download from the application to use.

How to use.

CAUTION

- When using a washing tub cleaner (ensure ventilation).
- Do not put the washing tub cleaner etc. first. If you start with 3L or more of water in the drum, the operation will start after draining.

[Preparation] Open the tap

1 Press  to turn on the power

2 If you want to operate "Tub Wash" program, please press .

- The operating time can be switched by pressing the button.

Tub Wash (10 hours).

10h



Tub Wash (2 hours)

2h

If you want to operate "Hot Tub Wash" program, please select [Download] program.

- Please set the "Download" program by your application (Smartphone) in advance.

3 Close the door and press .

4 Water is supplied, and as soon as the water surface is visible in the drum, press the  button again.

- If you operate "Tub Wash" program, please input the tub cleaner into the drum.

Care and Maintenance (Continue)

5

Close the door and press  .

6

Clean the drain filter after operation.

→ Page 51 : How to clean the drain filter

When using a washing tub cleaner (ensure ventilation)

- Use chlorine bleach for clothes or chlorine bleach for washing tub.
- Carefully read the precautions and amount used for washing tub cleaners and various bleaches before using.
Ventilate well when using laundry tub cleaners and various bleaches.
- If the usage amount is not indicated, use approximately 200mL.
- Do not use oxygen bleach or kitchen bleach. A large amount of bubbles will be generated, which may cause equipment failure or water leakage.
- When putting it in the drum, be careful not to get it on the surface of the machine. If it does, wipe it off immediately.

CAUTION

- When use "Hot Tub Wash" program, do not put the washing tub cleaner because Hazardous gas may be generated.

Notice of tub cleaning and maintenance time (For model BD-120XGV/BD-100XGV)

If you set the notification from the app, the smartphone will be notified when it is time to clean the tub. For more information on setting up notifications, please check the app settings.

Cleaning the drain filter

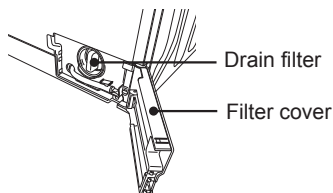

 Risk of injury!

Hot water may come out from the drain tube and drain filter.





- Do not open the drain filter when a program is running.
- Do not clean the drain filter just after a program using hot water.
- Do not operate the washing machine without the drain filter.

Preparation

Perform a spin operation before removing the drain filter to confirm that the water has been drained.

Select the Spin program and start to drain remaining water in the drum. Make sure to drain the water first, otherwise a lot of hot water may come out.

Operate "Spin"

- 1 Close the door, press  to turn on the power.
- 2 Press  to select the spin program .
- 3 Press  to start.

1 Open the door and pull out the drain tube.

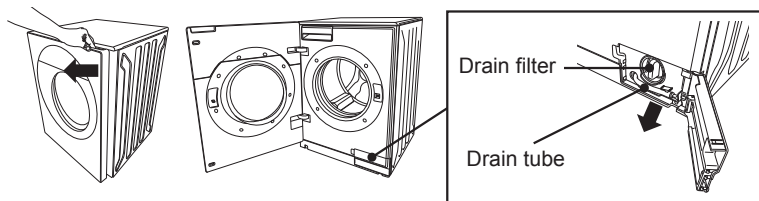

2 Remove the drain plug to drain the water.

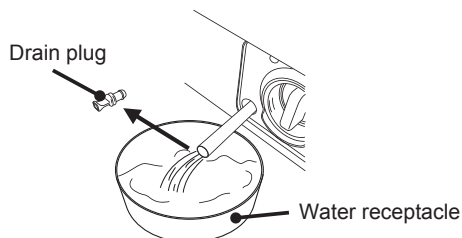

Care and Maintenance (Continue)

3

Remove the drain filter.

- 1 Turn the drain filter knob about 1 turn to the left.
- 2 Slowly pull out the drain filter toward you.
 - Residual water may come out, so please receive it with a water receiver.
 - Be careful not to let the drain accumulated inside the drain filter fall inside the main body.
 - If the drain filter insertion part is dirty, wipe it off with a cloth.

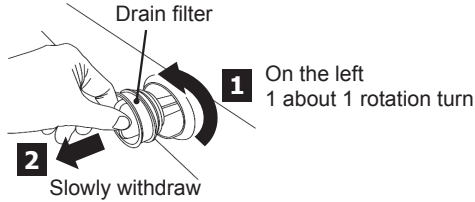

4

Remove drain and wash away.

- Remove only foreign matter such as drain without rubbing the rubber packing. If you wipe off the lubricant (white grease) on the rubber packing, it will be difficult to turn the drain filter.

If it is very dirty, clean it with a toothbrush or cotton swab.

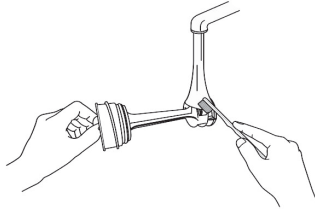

5

Install the drain filter

- 1 Insert the drain filter as far as it will go.
- 2 Turn the knob to the right until it clicks.

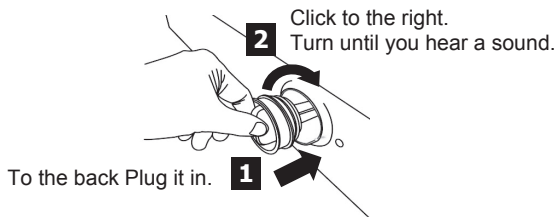

6

Close the Drain filter cover and the door

WARNING

- If the drain filter or rubber packing is damaged, replace it immediately. It may cause water leakage or malfunction.

Cleaning the liquid detergent and fabric softener dispenser.

For model : BD-120XGV/BD-100XGV

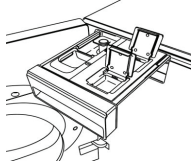

For model : BD-120GV/BD-100GV

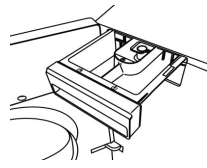

Please take care of it in the following cases.

- Once every 2 to 3 months (approximate).
- When changing the type of liquid detergent or fabric softener used.
- When the automatic input function has not been used for more than a month.
- When the **Empty** display is blinking and the automatic filling dispenser has not been refilled with liquid detergent or fabric softener for more than a week.
- When dirt remains on the dispenser mounting part.
- When the remaining amount is low.
- When the liquid detergent or fabric softener in the automatic loading dispenser becomes jelly-like.

Cleaning the liquid detergent and fabric softener dispenser

For model : BD-120XGV/BD-100XGV

- 1** Open the door of the washing machine.

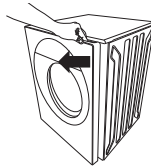

- 2** Hold the handle of the liquid detergent dispenser or fabric softener dispenser and pull it straight up to remove it.

- If you tilt the liquid detergent dispenser or fabric softener dispenser, the liquid detergent or fabric softener may spill or drip on the dispenser mounting part. Wipe it off with a soft cloth.

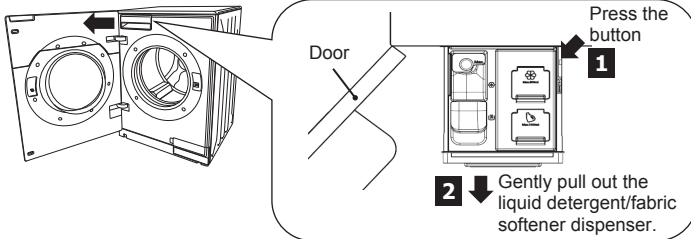

- 3** Clean the dispenser cover.

- 1** Open the knob on the dispenser cover, remove it from the claw, and remove the dispenser cover.

- 2** Rinse off dirt on the dispenser cover.

- If it is extremely dirty, soak it in hot water (about 40°C) for about 10 minutes and wipe it off with a damp cloth.

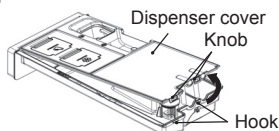

Care and Maintenance (Continue)

4

Clean the cover.

- 1 **Open the cover, pull it toward you, and remove the hook from the recess.**
- 2 **Rinse off dirt on the cover.**

If it is very dirty, soak it in hot water (about 40°C) for about 10 minutes and wipe it off with a damp cloth.

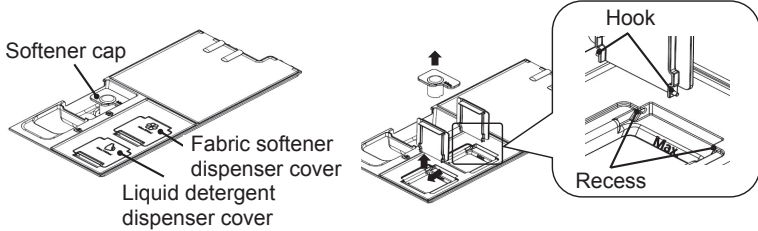

* If the softener cap is not installed correctly, it will not flow properly.

5

Clean the inside of the dispenser.

- 1 **Remove float cover and float from dispenser**
- 2 **Rinse the dirt inside the dispenser**

- Rinse the inside of the dispenser until there is no foaming or sliminess.
- If it is extremely dirty, soak it in hot water (about 40°C) for about 10 minutes and wipe it off with a damp cloth.

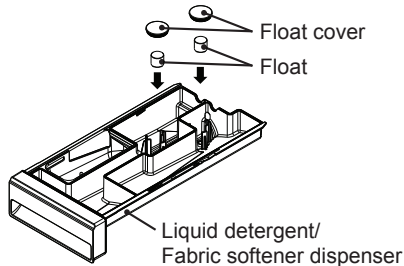

* When you install the float, please check if the light blue side of the float faces down.

* When installing float cover, push it until you hear a "click".

6

Reinstall the dispenser.

- 1 **Install the dispenser cover.**
Press until you hear a "click".
- 2 **Install the dispenser to the washing machine.**

If it is not installed securely, it will not be automatically charged during operation and may cause liquid detergent or fabric softener to leak.

Cleaning the liquid detergent and fabric softener route.
For model : BD-120XGV/BD-100XGV

After cleaning the liquid detergent and fabric softener dispenser, clean the liquid detergent/fabric softener route. Set the time to [4 minutes] if you are using automatic loading continuously or to [9 hours] if you are not using automatic loading continuously.

Cleaning the liquid detergent route.

[Preparation] Open the tap.

1 Open the cover of the liquid detergent dispenser and fill the dispenser with hot water (about 40°C).

Fill with the hot water up to [Max] mark.

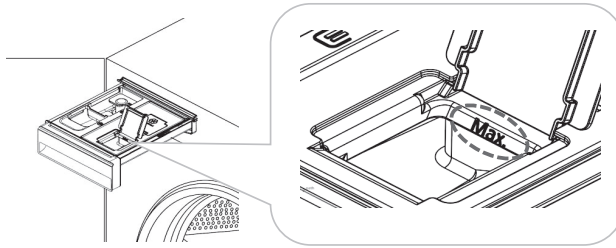

2 Close the cover of the liquid detergent dispenser.

3 Follow the instructions below to start the cleaning operation.

You cannot use the fabric softener and setting at the same time.

1 Press  to turn on the machine.

2 Press  for at least 3 seconds.

Press and hold the button after the tone and the number will appear in the remaining time display.

3 Press  and select [4 minutes] or [9 hours].

Each time you press the button, the display switches between [More] and [Less] and the time will be shown in the remaining time display.



4 Press  to start the machine.

After the time set above has elapsed, the machine will beep and turn off automatically.

Care and Maintenance (Continue)

Cleaning the fabric softener route.

[Preparation] Open the tap.

- 1** Open the cover of the fabric softener dispenser and fill the dispenser with hot water (about 40°C).

Fill with the hot water up to [Max] mark.

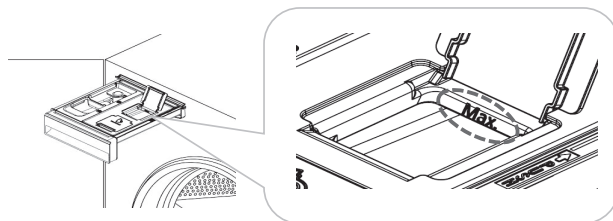

- 2** Close the cover of the fabric softener dispenser.

- 3** Follow the instructions below to start the cleaning operation.

You cannot use the liquid detergent and setting at the same time.

- 1** Press  to turn on the machine.

- 2** Press  for at least 3 seconds.

Press and hold the button after the tone and the number will appear in the remaining time display.

- 3** Press  and select [4 minutes] or [9 hours].

Each time you press the button, the display switches between [More] and [Less] and the time will be shown in the remaining time display.



- 4** Press  to start the machine.

After the time set above has elapsed, the machine will beep and turn off automatically.

After cleaning, remove the liquid detergent dispenser or softener dispenser, discard any remaining water and wipe the inside of the dispenser and the area around the dispenser mounting part thoroughly with a soft cloth.

Cleaning the liquid detergent and fabric softener dispenser
For model : BD-120GV/BD-100GV

1 Open the door of the washing machine.

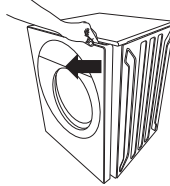

2 Hold the handle of the liquid detergent dispenser or fabric softener dispenser and pull it straight up to remove it.

- If you tilt the liquid detergent dispenser or fabric softener dispenser, the liquid detergent or fabric softener may spill or drip. Wipe it off with a soft cloth.

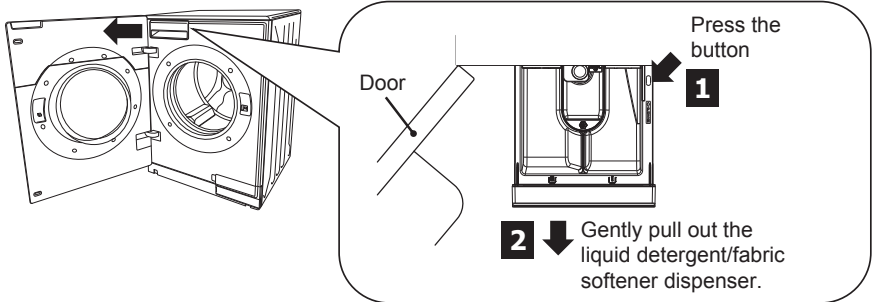

3 Clean the inside of the dispenser.
Rinse the dirt inside the dispenser.

- Rinse the inside of the dispenser until there is no foaming or sliminess.
- If it is extremely dirty, soak it in hot water (about 40°C) for about 10 minutes and wipe it off with a damp cloth.

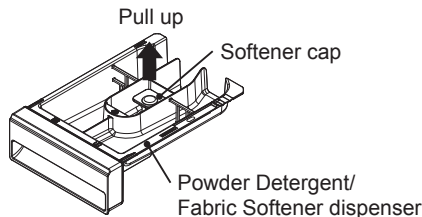





* If the softener cap is not installed correctly, it will not flow properly.

4 Reinstall the dispenser to the washing machine.

Troubleshooting

In this case	Check here
<p>I want to use my mobile router.</p>	<p>Mobile routers are not guaranteed to work. Some may not work even if they support IEEE802.11b/g/n (2.4GHz band only).</p>
<p>I want to use the App without registering.</p>	<p>To use the App, Please register to use through the application from your smartphone.</p>
<p>I want to log in to multiple smartphones using the same login ID.</p>	<p>You can only log in to the App on one smartphone per login ID. If you log in from more than one smartphone using the same login ID, the smartphone logged in first will be logged off.</p>
<p>The washing machine cannot be paired with a smartphone.</p>	<p>Please make sure that you have an appropriate condition for wireless LAN connection between your washing machine and your smartphone. → (p. 19)</p>
	<p>Make sure that the wireless LAN function of the washing machine is set to "On (The wireless LAN function)"</p>
	<p>Make sure that the (communication lamp) 「」 on the washing machine is lit.</p>
	<p>Make sure that your wireless LAN router is switched on. Please check your wireless LAN router's instruction manual and turn it on.</p>
	<p>Make sure that the SSID and password (e.g., "encryption key" or "security key") of your wireless LAN router are correct.</p>
	<p>Make sure that your wireless LAN router is not in stealth mode (SSID hidden). Please disable the stealth mode before pairing. Please refer to your wireless LAN router's user manual for how to disable the stealth mode. After pairing, please return to the stealth mode setting with your wireless LAN router.</p>
	<p>Pairing cannot be performed when MAC address filtering is set on the wireless LAN router. Please check the instruction manual for your wireless LAN router and cancel the MAC address filtering setting before pairing. To set the MAC address filtering again, please register the washing machine's MAC address to the wireless LAN router after pairing is completed. For the MAC address of the washing machine, please refer to "Checking the MAC address" on page 32.</p>
<p>Microwave ovens that use the 2.4GHz band or devices that use Bluetooth in the vicinity may cause a temporary interruption or slowdown in communication.</p>	



In this case	Check here
Unable to pair the washing machine with a smartphone.	<p>If the washing machine and the wireless LAN router are far apart, the signal may be weak. Please move the wireless LAN router closer to the washing machine or use a repeater for the wireless LAN router.</p>
	<p>Pairing can only be carried out with one device at a time. Do not pair with more than one smartphone at the same time.</p>
	<p>You can only pair up to 5 smartphones with your washing machine. With the paired smartphones, delete the unwanted registrations from "Menu", "Connection Settings", "Name settings", and "Check/delete registered users" in the application.</p>
	<p>When pairing the smartphone with the washing machine, after selecting the SSID of the washing machine, the message "Your smartphone is not connected with the router" may appear. In this case, the pairing may fail. You may be able to proceed with pairing by doing the following:</p> <ul style="list-style-type: none"> • If you see the "Your smartphone is not connected with the router" message, select the router that you want to connect from Wi-Fi setting in your smartphone.
Easy connection fails.	<p>If this is not the case, please turn off your washing machine, smartphone, and wireless LAN router, wait a few moments and then turn them back on again.</p>
	<p>If pairing fails without a "✓" mark in [Step 1] to [Step 2] on the application screen display, please try pairing again, paying attention to the following information.</p> <hr/> <p>If you do not get a "✓" mark on [Step 1]</p> <ul style="list-style-type: none"> • When you press the wireless connection button on the wireless LAN router, make sure it is connected to the 2.4GHz band. For the wireless LAN router's status, when you press the wireless connection button, please refer to the instruction manual of the wireless LAN router. • When you change the washing machine to pairing mode, make sure that "Pr 1" is flashing. If "Pr 1" is lit instead of flashing, press the "Remote" button on the washing machine. • Make sure that your smartphone is connected to the wireless LAN router to which the washing machine is connected. On the App screen, check that the SSID of the wireless LAN router to which your smartphone is connected is correct. If it is not, change the connection point in the Wi-Fi settings of your smartphone. • After pressing the wireless connection button on the wireless LAN router and changing the washing machine to pairing mode, check that the (communication lamp) 「」 on the washing machine changes from flashing to lit. If the (communication lamp) 「」 does not light up, please check the details described in the section "Unable to operate the machine from a smartphone".
	<p>If you do not get a "✓" mark in [Step 2]</p> <ul style="list-style-type: none"> • Depending on your wireless LAN router's configuration and environment, the connection may be unstable and fail to connect. • Make sure that the (communication lamp) 「」 on the washing machine is lit. If (communication lamp) 「」 is not lit, please check the information in the section "Unable to operate the device from a smartphone".

Troubleshooting (Continue)

In this case	Check here
Manual connection fails.	If pairing fails without a "✓" in [Step 1] to [Step 4] on the application screen, please try pairing again, paying attention to the following information.
	If you do not get a "✓" mark in [Step 1] <ul style="list-style-type: none"> Your smartphone may not have been able to connect to the washing machine's SSID. If a message about the network connection is displayed give you select the SSID of the washing machine in your smartphone's Wi-Fi settings to connect to the SSID of the washing machine. → (p.25) ※ Depending on your smartphone model and operating system.
	If you do not get a "✓" mark in [Step 2] <ul style="list-style-type: none"> Your smartphone may not have been able to reconnect to your wireless LAN router. Please go to the Wi-Fi settings on your smartphone and connect to the SSID of the wireless LAN router that you want to connect your washing machine. → (p.24)
	If you do not get a "✓" mark in [Step 3] <ul style="list-style-type: none"> Depending on your wireless LAN router's settings and environment, the connection may be unstable and fail to connect. Please check the information in the section "I cannot operate the device from my smartphone."
	If I do not get a "✓" mark in [Step 4] <ul style="list-style-type: none"> The washing machine may not be connected to the wireless LAN router. Ensure the SSID of the wireless LAN router to which your smartphone is connected is in the 2.4GHz band when pairing. → (p.24) Please make sure that you have entered the correct password ("encryption key" or "security key") for your wireless LAN router in the application. → (p.24)
I do not know the SSID or password for my wireless LAN router.	Check the instruction manual of your wireless LAN router. The password may be referred to as "encryption key" or "security key" depending on your wireless LAN router's make and model.
Cannot put remote control in standby state.	Make sure that your wireless LAN router is switched on. Please refer to your wireless LAN router's instruction manual and turn it on.
	You will not be able to put in remote control standby mode unless you have completed the pairing settings. → (p.29)
Unable to control the device from my smartphone. Unable to accept operation.	The washing machine must be in the remote-control standby mode to operate the machine from your smartphone. → (p.29) If the washing machine is running or paused, you cannot operate it from your smartphone.
The operating status of the washing machine is different from that indicated in the push notification.	Depending on the server's state and the mode of communication between the washing machine and the smartphone, the washing machine's operating status may be notified later.

In this case	Check here
<p>I do not receive any push notifications.</p>	<p>When the (communication lamp) 「」 on the washing machine is blinking, the machine is preparing for communication, and you will not receive any push notifications. Immediately after switching on the washing machine, it is in the process of preparing for communication, so please wait a moment.</p> <p>Make sure you have set up notifications for the App in the Settings section of your smartphone.</p> <p>Make sure your notifications are set up in the App's 'Notification settings'.</p>
<p>The status displayed in the App is different from the behavior of the washing machine.</p>	<p>Depending on the server's state and the mode of communication between the washing machine and the smartphone, the display on the application may differ from the washing machine's operating status.</p>
<p>The time remaining displayed in the App is different from the time remaining displayed on the device.</p>	<p>Depending on the state of the server and the communication between the washing machine and the smartphone, the display on the application may differ from the display of the remaining time on the washing machine.</p>
<p>I want to change my wireless LAN router.</p>	<p>To change the wireless LAN router to which the washing machine is connected, tap the "Menu" button on the application, select "Connection Settings", and then "Network Settings." Follow the on-screen instructions. If you are unable to change the wireless LAN router, please also check "Unable to pair the washing machine with a smartphone"</p>

Troubleshooting (Continue)

Problem	Possible Cause	Solution
Door cannot be opened.	<ul style="list-style-type: none"> • There is still some water in the washing machine. • Child lock may be activated. • Washing machine may be switched off before the door lock is released. • Washing machine may be using the remote function, the door will be locked. (For model BD-120XGV/BD-100XGV) 	<ul style="list-style-type: none"> • Run the Drain program to drain water. • Deactivate the child lock. (See page 16) • Push the Power button to switch power on. The door lock will be released if there is no water in the drum. • Deactivate "Remote function"
Buttons do not work.	<ul style="list-style-type: none"> • Child lock may be activated. • Settings cannot be changed while a program is in progress. 	<ul style="list-style-type: none"> • Deactivate the child lock. (See page 16)
Water is not supplied.	<ul style="list-style-type: none"> • The water tap may not be turned on. • The water supply hose may be frozen. • The water supply hose may be kinked or pinched. • The water supply filter may be clogged. 	<ul style="list-style-type: none"> • Turn on the water tap. • Make sure that the water supply hose is not frozen. • Straighten the water inlet hose. • Clean the water inlet filter. (See page 48)
Displayed remaining time changes.	<ul style="list-style-type: none"> • Washing time may be prolonged if the load is unbalanced, as the washing machine tries to correct the imbalance. • Washing time may be prolonged when there is too much foam, as the additional action of eliminating it is necessary. • The remaining time is continually corrected and may change during the program. 	<ul style="list-style-type: none"> • This is not a malfunction. • Use the appropriate amount of detergent. • This is not a malfunction.
There's no foam or hardly any foam.	<ul style="list-style-type: none"> • The amount of foam varies depending on the temperature, level of soiling and water hardness. • Detergent may remain undissolved if it is poured directly into the drum. 	<ul style="list-style-type: none"> • Use the appropriate amount of detergent.
There's a lot of foam.	<ul style="list-style-type: none"> • You may have used too much detergent. • The amount of foam varies depending on the temperature, level of soiling and water hardness. 	<ul style="list-style-type: none"> • Use the appropriate amount of detergent.
Detergent in the dispenser  is not washed away.	<ul style="list-style-type: none"> • You may not have selected the Prewash option. • The detergent in the dispenser  is for prewash only. 	<ul style="list-style-type: none"> • If you are using prewash, push the Prewash button.

Problem	Possible Cause	Solution
Rinsing begins before spinning finishes.	<ul style="list-style-type: none"> ● If there is imbalance in the drum, rinsing restarts automatically to correct it for safety reasons. 	<ul style="list-style-type: none"> ● This is not a malfunction.
The drum stops and rotates repeatedly during spin.	<ul style="list-style-type: none"> ● If there is imbalance in the drum, the washing machine tries to correct the imbalance by repeatedly rotating and stopping. 	<ul style="list-style-type: none"> ● This is not a malfunction.
Spin cycle repeatedly starts and stops.	<ul style="list-style-type: none"> ● Intermittent spinning of the tub helps the spin process to operate quietly. ● The laundry may be too light. 	<ul style="list-style-type: none"> ● Add one or two bath towels to the drum.
Foam remains on the door or the door seal.	<ul style="list-style-type: none"> ● You may have used too much detergent. ● Laundry is new or not that soiled. 	<ul style="list-style-type: none"> ● Use the appropriate amount of detergent.
Fabric softener overflows.	<ul style="list-style-type: none"> ● You may have exceeded the max. level of softener in the Softener dispenser . 	<ul style="list-style-type: none"> ● Do not pour in more than the max. level of softener.
Fabric softener remains.	<ul style="list-style-type: none"> ● The softener cover may have come out. 	<ul style="list-style-type: none"> ● Firmly set the softener cover on the softener dispenser.
There's detergent powder residue in the detergent dispenser.	<ul style="list-style-type: none"> ● You may have used too much detergent. ● You may have poured detergent in the detergent dispenser when it was wet. Wipe the water away before adding detergent. 	<ul style="list-style-type: none"> ● Use the appropriate amount of detergent. ● Wipe the water away before adding detergent.
The washing machine switches off during operation.	<ul style="list-style-type: none"> ● There may be noise from other electrical appliances nearby such as a TV, a radio, etc. ● The motor may be locked due to overload, the clothes being trapped in the rubber seal, etc. 	<ul style="list-style-type: none"> ● Unplug the power cord and plug in again. Then select a program and start. Do not place electrical appliances close to the washing machine. ● This is not a malfunction. Wait for about one hour and restart the program.
Odor in the washing machine	<ul style="list-style-type: none"> ● Rubber parts may give off a smell when you first start using the washing machine. ● There may be mold, dirt or detergent residue on the drum. 	<ul style="list-style-type: none"> ● The smell goes away over time. ● Run the Tub Wash program.
Unsatisfactory washing results	<ul style="list-style-type: none"> ● You may have used too little detergent. ● You may have poured detergent directly into the drum. 	<ul style="list-style-type: none"> ● Use the appropriate amount of detergent. ● Pour detergent in the appropriate dispenser.

Troubleshooting (Continue)

Problem	Possible Cause	Solution
Unusual noise or vibration	<ul style="list-style-type: none"> ● The transport bolts may not have been removed. ● The washing machine may be installed on a sloping or unstable surface. ● There may be foreign objects inside the drum. 	<ul style="list-style-type: none"> ● Remove the transport bolts before using. ● Install the washing machine on a horizontal, stable surface. ● Remove foreign objects such as coins, pins, etc. from the drum.
Noise during drain cycle	<ul style="list-style-type: none"> ● This is normal. There may be noise when the drain pump is on. 	<ul style="list-style-type: none"> ● This is not a malfunction.
There's the sound of water when the drum is rotated manually.	<ul style="list-style-type: none"> ● The sound of water flowing when the drum is turned by hand when the machine is not running. This is the sound of the water in the balance ring, which is used to balanced. 	<ul style="list-style-type: none"> ● This is not a malfunction.
Tapping noise comes out at spin start.	<ul style="list-style-type: none"> ● This is normal. Tapping sound is generated when laundry touches to the laundry protection bulge on the laundry inlet. 	<ul style="list-style-type: none"> ● This is not a malfunction.
Dispenser is wet.	<ul style="list-style-type: none"> ● In some environmental or usage conditions, Dispenser may get wet due to condensation. 	<ul style="list-style-type: none"> ● This is not a malfunction.
Water remains in washing machine before initial use.	<ul style="list-style-type: none"> ● There may be drops of water or condensation in the washing machine due to the factory inspection prior to shipment. 	<ul style="list-style-type: none"> ● This is not a malfunction.

Error Codes

Code	Description	Possible Cause	Solution
C01	No water supply.	<ul style="list-style-type: none"> • Water tap may not be turned on. • Water inlet filter may be clogged. • Water line or water hose may be frozen. • Water supply may be cut off. 	Check water tap, water inlet filter, water line and water hose.
C02	No water drain.	<ul style="list-style-type: none"> • Drain hose or drain pump may be clogged. • Drain hose may be kinked or frozen. • Drain hose may not be set correctly. • Height of the drain outlet may be too high. 	Check drain hose, drain pump and drain outlet. If C02 still appears after removing the possible cause, please contact your local service center for repair.
C04	Can not spin (Laundry is unbalanced).	<ul style="list-style-type: none"> • Clothes may be imbalanced in the drum. • You may be washing only one heavy item such as a cotton blanket or jeans, or small items in a laundry net. • You may be washing too many large items such as bed sheets. • The washing machine may be installed on a slanting floor or may not be level. • You may be washing waterproof or antislip treated items. → Page 26 : Before You Start Washing (Sorting of the laundry) 	Add a few clothes to the drum. (Spinning only one item may result in imbalance.)
C08	The door is open.	<ul style="list-style-type: none"> • The door may be open. • The door may not be closed completely. 	Check the door and close firmly.
C09	The door will not unlock.	<ul style="list-style-type: none"> • Laundry may be exceeded rated load and door is pushed from inside. 	Switch power off and press the door to close tightly. Hold that position and switch power on, and wait until the door lock is released.
C18	Can not spin (No drain or Many bubble).	<ul style="list-style-type: none"> • The drain hose may not be set correctly. • There may be too much foam in the drum. 	Same as in C02 & C20.
C19	Capacity over.	<ul style="list-style-type: none"> • Laundry may exceed rated capacity. 	See page 37 for max. load of each program.
C20	Drum does not rotate.	<ul style="list-style-type: none"> • There may be too many clothes. • Clothes may be tangled. • There may be too much foam in the drum. • The power cord may be extended too far. • There may be other equipment connected to the same power socket. 	To eliminate the excessive foam, switch off the washing machine and wait for about 30 mins, then switch on again and select Rinse & Spin without adding detergent.
C30	Water flows out from drain hose while washing.	<ul style="list-style-type: none"> • Drain hose end is set lower than 60 cm. 	See page 11 for proper height on drain hose setting.
C42 (*)	Failed to update the machine software	<ul style="list-style-type: none"> • Software update failed. 	Please unplug and the power supply.

(*) For model BD-120XGV/BD-100XGV

Specifications

Model	BD-120XGV
Power supply	See the rating plate attached to the rear of the washer
Water pressure	0.03-0.8 MPa (0.3-8 kgf/cm ²)
Dimensions	W 600 mm. x D 650 mm. x H 850 mm.
Weight	68 kg.

Model	BD-100XGV
Power supply	See the rating plate attached to the rear of the washer
Water pressure	0.03-0.8 MPa (0.3-8 kgf/cm ²)
Dimensions	W 600 mm. x D 650 mm. x H 850 mm.
Weight	68 kg.

Model	BD-120GV
Power supply	See the rating plate attached to the rear of the washer
Water pressure	0.03-0.8 MPa (0.3-8 kgf/cm ²)
Dimensions	W 600 mm. x D 650 mm. x H 850 mm.
Weight	68 kg.

Model	BD-100GV
Power supply	See the rating plate attached to the rear of the washer
Water pressure	0.03-0.8 MPa (0.3-8 kgf/cm ²)
Dimensions	W 600 mm. x D 650 mm. x H 850 mm.
Weight	68 kg.

3WPL147262