

使用說明書 INSTRUCTION MANUAL

HITACHI
Inspire the Next

日立多門電冰箱 REFRIGERATOR-FREEZER

家庭用 For household use

型號 Model
R-ZX740KN R-ZX740KM R-ZX740KA R-WX670KN
R-WX670KM R-WX670KA R-WX620KM R-WX620KA
R-ZX740KSE R-WX740KSE R-WX670KSE R-WX620KSE



日本製
Made in Japan

六門 6 doors

非常感謝您購買日立電冰箱。

此電冰箱僅供家庭使用，請勿使用於商業用途和儲存食品以外的目的上。

請詳閱本使用說明書，以確保正確使用。

使用前請務必詳閱「安全上之注意事項」。

請妥善保管本使用說明書與保證書，當將電冰箱交給他人，在別的場所使用時，以及交給回收工廠時，請將本使用說明書隨電冰箱一同轉交。

Thank you very much for purchasing a Hitachi Refrigerator.

This refrigerator is designed for home use only. Do not use this refrigerator for the business use and/or any purpose other than storing food.

Please read this operation manual carefully and ensure you use the appliance correctly. In particular, be sure to read the "Safety Suggestions" section of this operation manual before use.

Please keep this operation manual along with your guarantee card.

Hand over this operation manual together with the refrigerator when the refrigerator is passed to a third party and used in a different location, or when it is sent to a recycling plant.

● **購買後初次使用時。** → 8, 9頁

初次使用時，庫內冷卻可能需要約4小時至24小時以上。

● **請遵守可容納食物的高度及食品之間空開間隙儲放。** → 20, 23頁

過分塞堵食物，會造成食品及袋子被門夾住關不緊，製冷效率低，不能製冰等。

● **It takes time to cool for the first time.** → Pg.58, 61

It may take more than 4 ~ 24 hours to fully cool.

● **Make sure that no food protrudes beyond the storage height limit of each compartment, and allow clearance between each food in each compartment.** → Pg.68, 71

Otherwise, food and/or package may not be stored in each compartment properly, and as a result, the door may not be closed completely. It may cause the refrigerator not to cool sufficiently and/or not to make ice.

節省能源的使用方法

Tips for using the refrigerator wisely for energy savings

1. 減少冰箱門的開閉，切勿時間過長

開閉次數多，冷氣向外流失，保冷效果差。

2. 切勿塞滿過多的食物

一旦塞滿過多的食物，冷氣的流通循環不良，不僅無法讓冰箱內均一冷卻，而且還會消耗電力。存放食品時請適度地保留間隙。

3. 將熱的食物放冷之後再放入冰箱

將熱的食物放入冰箱時，冰箱內部的溫度升高，周邊食物的溫度也隨之升高。

4. 冰箱周邊應保留適當的間隙

若周邊無保留間隙時，冰箱無法散熱，而導致電力的浪費。

5. 更換受損的冰箱門墊圈

因受損後所產生的間隙可讓冷氣流失，而導致電力的浪費。將名片等夾在其間，若因無法夾緊而滑落，請更換冰箱門的墊圈。

1. Open or close a door less frequently and quickly.

Frequent opening and closing leads to waste of energy.

2. Do not overfill the refrigerator.

Overfilling the refrigerator prevents a smooth circulation of cool air, precluding even cooling throughout the refrigerator and consuming unnecessary power. Place food at appropriate intervals.

3. Do not place hot food in the refrigerator.

Placing hot food raises the temperature in the refrigerator, which, in turn, raises the temperature of surrounding food.

4. Provide an appropriate gap around the refrigerator.

Installing the refrigerator with little clearance between the refrigerator and the surrounding objects prevents the release of heat and thus leads to the waste of power.

5. Replace a damaged door gasket.

Cool air leaks through a damaged gasket, which leads to the waste of power. If a name card inserted between the gasket and the refrigerator slides down, the gasket needs replacing.

常見問題 FREQUENTLY-ASKED QUESTIONS (FAQs)

無法製冰時

→ 34頁

If the ice is not made

→ Pg.72

冰箱內冷度不夠時

→ 35頁

If the refrigerator is not cooled down well

→ Pg.73

結霜或結露時

→ 35頁

If frost or dew is formed

→ Pg.73

目錄

使用之前

安全上的注意事項	4
事前準備	8
使用前的準備	8
確認事項	10
各室的名稱・概略的溫度・存放食物	10
操作面板的功能	11

使用方法

電動門	12
設定電動門	12
使用電動冷藏室門	13
使用電動抽屜	13
冷藏室	14
調節溫度	14
調整置物架・層架的高度	14
讓食品更低溫保存時 (使用「Sensor Cooling」功能)	15
想要急速冷卻食品時 (使用「Spot Powerful Cooling」功能)	15
真空冰溫室	16
區分使用的要點	16
變更真空冰溫室的設定	17
關閉真空冰溫室門	17
製冰室 (自動製冰機)	18
製冰方法	18
收納量・製冰時間	19
急速製冰	19
製冰停止	19
告知給水警示燈	19
「On」或「Freezer」[■][■][■][■]及「Fridge」[■]閃爍時	19
冷凍室	20
收納食品	20
收納食品時	20
調節溫度	21
使用即鮮冷凍	21
蔬果保鮮室	22
收納食品	22
蔬果保鮮室的溫度調節 (蔬果室強)	22
收納食品時	23
蔬菜保存要領	23
各種功能	24
溫度微調節 (冷藏室・冷凍室)	24
操作面板鎖定功能	24
箱門警報器	25
箱門警報器及操作音的音量調節	25
三重抗菌除臭	25
省電	26
eco 運轉顯示燈	26
冰箱門關閉顯示燈	26
「節電」模式的設定	27
將防止結露的加熱器設定為弱 (旋轉隔板部)	27

保養方法

保養方法	28
電源插頭 / 箱門密封墊	28
箱門表面 / 各層架・置物架 / 置物盒	28
冰箱背面・地板 / 液汁承接處	28
真空冰溫室	29
電動抽屜	29
製冰機清潔	30
給水槽	31
製冰盤	31
卸除組件的方法・安裝的方法	32
可調式層架上段・中段	32
固定層架	32
可調式層架下段	32
箱門置物架	32
真空冰溫室	32
製冰盒 (製冰室)・上層冷凍盒 (上層冷凍室)	33
中層滑動盒・下層冷凍盒 (下層冷凍室)	33
上層滑動盒・下層置物盒 (蔬果保鮮室)	33
拉取式門的安裝方法 (製冰室・上層冷凍室・ 下層冷凍室・蔬果保鮮室)	33
遇到問題時	34
遇到問題時	34
初次使用時	34
操作面板	34
自動製冰	34
不冷	35
結霜・結露	35
顯示部正在閃爍	35
太冷	36
聲音不對	36
箱門高低不平衡以及歪斜	36
冰箱發熱	36
真空冰溫室的問題	36
有異味	37
蔬果保鮮室	37
電動冷藏室門	38
電動抽屜	38
其他	39
移動・搬運的事前準備 (搬家時)	40
另購零件	40
有關碳化合物的冰箱 / 可容納的食品重量	79

使用之前

使用方法

保養方法

遇到問題時

3

安全上的注意事項

請務必遵守

為了防止危害到使用者或其他人及造成財務上的損失，請務必遵守以下事項。

■ 以下將以標示方式，區分及說明忽視標示內容而誤用時所產生的危害與損失程度。

■ 以下將以圖示標示方式，區分及說明應遵守內容的種類。(以下為圖示標示例)



警告

此標示欄表示「可能會造成死亡或嚴重人身傷害」。



注意

此標示欄表示「可能會發生人身傷害或財產損失之預測內容」。



此圖示標示為「禁止」內容(請勿執行之事項)。



此圖示標示為「強制」內容(請務必執行之事項)。

■ 此冰箱使用可燃性的冷煤。以下的標示欄記載關於可燃性冷煤的注意事項。



R600a

此圖示標示為可燃性冷煤的注意事項。

警告

安裝時



- 針對地震等天然災害做好防止翻倒處置。
 - 避免因翻倒而受傷。



禁止淋濕

- 請勿設置於潮濕或會被水淋到的場所。
 - 避免因電氣絕緣不良而引起觸電、火災的危險。



電源及電源電線



禁止

- 使用時請勿高於插座或配線器具的額定電流。
 - 請勿使用交流額定電壓以外的電源。
 - 若與其他電器插頭併用，或使用三面插座等，會因異常發熱而造成火災的危險。
 - 請單獨使用額定電流 10A 以上的插座。

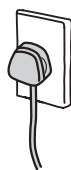

- 設置本產品時，請確認電源線是否有拉扯、損傷的跡象。

請勿讓電線受損、加工、接近發熱器具、勉強彎曲、扭曲、拉扯、乘載重物、讓冰箱壓住電線或捆綁電線。

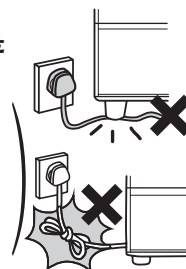

在已受損的狀態下使用時，會引發觸電、短路、火災的危險。

- 若電源線損壞時，必須由製造商、其服務處或具有相關資格的人員加以更換以避免危險。



- 將插頭的電線向下，將插頭確實插入插座內。
 - 如果插頭方向相反插入，會給電線增加負擔，成為短路、觸電、起火的原因。
 - 如果插頭插得不夠完全，也將會成為因觸電，發熱而導致火災的原因。

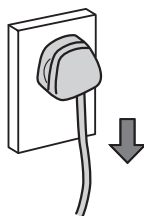

- 請定期清除插頭上的灰塵。
 - 當插頭堆積灰塵時會因濕氣而造成絕緣不良，進而引起火災。
 - 請拔除插頭再用乾布擦拭乾淨。



警告

電源及電源電線



禁止濕手

- 請勿用潮濕的手，拔除插頭。
 - 會引起觸電。
- 本電器不能在沒有人員監督以及指示之下，讓體力、知覺、以及精神不健全的人獨自操作 (包含小孩)。並請注意以及隨時監督切勿讓小孩玩耍本電器。



- 進行冰箱保養，請務必拔掉插頭。
 - 有觸電或受傷的危險。
- 28頁
- 請將插頭確實的從插座內拔出。

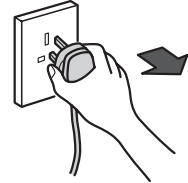

在一般使用的情況下



禁止淋濕

- 請勿用水淋濕主體與箱內。
 - 避免因電氣絕緣不足而引起觸電、火災。

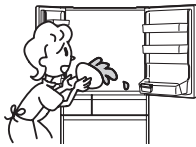

- 請勿將含水容器放在冰箱上。
 - 翻倒的水會造成電氣組件絕緣不良而發生漏電、火災、觸電的危險。



禁止

- 請勿放入容易引火的物品。
 - 揮發油、乙醚、LP 瓦斯、稀釋液、黏著劑會發生引爆的危險。

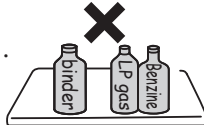

- 請勿用來保存藥品或學術試樣。
 - 必須嚴格管理的物品，不可保存於家庭用冰箱內。



- 請勿放置乾冰。
 - 放入袋中有破裂的危險。

- 在附近請勿使用可燃性噴霧用品。
 - 避免因箱門開關等電氣接點引起的火花引發火災。



- 請勿在冰箱上放置物品。
 - 避免因開閉箱門，造成物品掉落而受傷。



- 請勿懸在箱門上嬉戲，或踏在收納盒上。
 - 避免因翻倒，夾到手指而受傷。



- 請不要拆卸冰箱內燈的蓋子。
 - 燈泡損壞時，須由製造廠商或其服務處或具有相關資格的人員加以更換以避免危險。

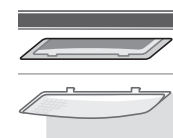

- 不要用力碰撞門。

- 不要將箱門開得過大或靠在打開的箱門上等給箱門施加太強的力。

- 請勿在設備後部放置多個可攜式插座或可攜式電源。



禁止接觸

- 請勿手觸自動製冰機的機械部位。
 - 製冰盤旋轉時，手恐怕會受傷。



- 請注意不要讓孩子們玩耍。

- 如果幼兒可能玩耍電動冷藏室門或電動抽屜時，請停止使用電動門的功能。→ 12頁



警告



關於冷媒（由於這是一種可燃性的氣體 R600a: 異丁烷，請注意以下的事項。）



禁止

- 不可以螺絲等銳利物品刮傷冰箱雪櫃。
由於使用可燃性的冷媒，當冷媒從冰箱內壁的配管外洩，會有起火、爆炸的危險。

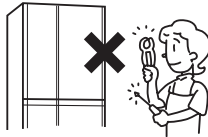

- 除廠商建議方法外，不得使用機械工具或其它工具來加速除霜的過程。
- 請勿在冰箱內部使用電器用品。
· 如冷媒外洩，電氣接點所產生的火花，會有起火、爆炸的危險。



- 請勿損傷冰箱的冷卻管路。

冷媒配管損壞時，請將冰箱遠離火源並避免使用電器用品。
配管損壞時，請儘快將門窗打開，並與經銷商或日立技術中心聯絡。

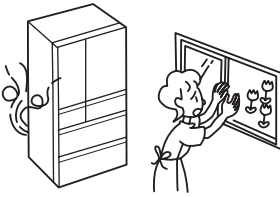

- 安裝的時候，在周圍要離開一些間隙，確保有足夠的散熱空間。

→ 8頁

若冷媒外洩的情況持續，會有起火、爆炸的危險。

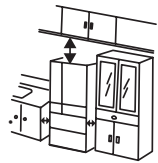

- 如需進行廢棄處理時，請聯絡經銷商或環保署資源回收中心專線，交給他們進行專業處理。
若冷媒外洩會有起火、爆炸的危險。



R600a

- 警告標籤和銘牌必須一直牢固張貼於壓縮器上和冰箱上。

- 使用過的可燃性製冷劑的處理、維修和安裝只能由日立授權服務公司或維修人員實施。

萬一有下列情形



- 當產品異常或故障時，請拔掉插頭停止運轉。
有觸電或受傷的危險。
· 請務必在拔除插頭時握住插頭。

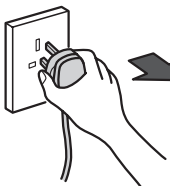

禁止分解

- 請勿自行分解、修理、改造。
避免發生火災，異常動作而受傷。
· 需分解、維修時，請洽經銷代理商。



- 可燃性氣體外漏時，勿接觸冰箱，請立即開啟窗戶進行換氣。
· 避免因箱門開關等電氣接點的火花，而發生引爆、火災、燙傷等危險。



廢棄處理時



- 在等待廢棄物再利用保管之際，因有幼兒被誤困在箱內之虞，請將門墊拆下來。



注意

移動・搬運時



禁止

- 請勿在容易刮傷的地板上使用冰箱滑輪。
避免因滑輪而刮傷地板。
 - 請在容易刮傷的地板上鋪上保護板。
- 請勿以吊車吊起手柄部位。
- 請勿碰撞冰箱背面・側面。

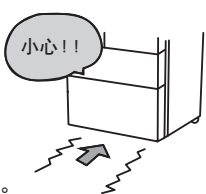

- 搬運時，請用手持手把搬運。
倘若沒有手持把手，可能會因手滑而受傷。
 - 請僱用 2 人以上手持手把搬運。
 - 搬運時請如圖示般將箱門朝上。
 - 為了防止電源插頭、電線下垂，請以膠布固定。

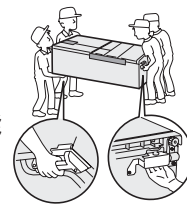

在一般使用的情況下



禁止

- 請勿在超大瓶飲料的縫隙間再塞入其他瓶罐。
 - 勉強放入超大瓶飲料瓶後，在開閉箱門時，可能會因掉落而受傷。



- 請勿將瓶子放在冷凍室內。
 - 內容物結凍會使瓶子破裂，容易受傷。
- 當打開冰箱門時，若其他門也在進行開閉動作時，為了避免被打開的冰箱門之間夾傷手或手指，請格外注意。

- 關閉冰箱門時，請勿握住冰箱門把手以外的部位進行關閉。

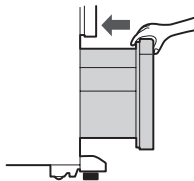

- 開啟最底層的箱門時，請勿讓腳靠近冰箱。
 - 避免在開啟箱門時，碰觸到底部而受傷。



- 手腳不要放進冰箱的底部。
清理時將手伸入冰箱底下時，可能會被鐵板割傷。

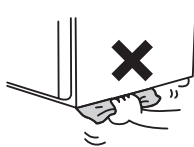

- 請勿施加強烈撞擊力於玻璃層架。(可能因玻璃層架破裂而導致受傷)

- 請勿讓食品凸出層架。
 - 避免因鈎到瓶罐後掉落而受傷。

- 開關冰箱門時，請勿過於用力。
(存放的食品有可能會掉落)

- 他人同時觸摸時請勿進行開閉動作。



- 請勿將手放在抽屜門把手上，開閉電動冷藏室門。

- 請勿用潮濕的手碰觸冷凍室內的食品或容器。
 - 避免凍傷。(尤其是金屬製產品)

- 請勿食用有異味，已變色的食品。
 - 避免因食品腐敗而引發疾病。

- 請勿用膝蓋去按電動抽屜的開關。



- 請勿把瓶子之類的物品放在電動抽屜附近。

- 請勿在玻璃層架的玻璃面上加熱，或放置熱的物品。

- 如果有人人在冰箱前，操作電動冷藏室門時，可能會因撞到打開的冷凍室門，而造成意想不到的傷害，請格外注意。



- 為了防止水滴到地板上。
長時間門與冰箱間有縫隙時，結露水或除霜水可能會滴下。請確實關緊冰箱門讓門與冰箱之間沒有縫隙。

- 冰箱門開啟的狀態下，開啟其他的門時，請注意切勿被開啟的冰箱門夾傷手或手指。

- 因為玻璃層架很重，安裝、拆卸時請格外注意。

- 開閉冰箱門時，若有異常聲音或磨耗粉末掉落等異常現象時，請停止使用，並請維修人員到府察看。

事前準備

使用前的準備

1

設置在以下的場所

- 堅固・水平的地板
地毯・榻榻米（日式草蓆地板）・木板地・塑膠地板等恐怕會有變形・變色的可能，請墊（超過 1cm 厚的）板材。
- 避免陽光直射和高溫
這些可防止冷卻功率下降，避免電費增加。
- 不潮濕・空氣流通的地方
而且可抑制變色以及生銹。
- 與其他的電器間隔一段距離
防止對電視等造成雜音或影像不安定等情形。
- 請預留散熱空間（右圖）
※ 雪櫃側面的中央部分是比所表示的尺寸稍大。
設置時請確保充裕的空間。
- ※ 若擔心背面牆壁變色或髒汙時，請預留間隙（2cm 以上）。另外也可以防止震動音，或濕氣較高時的背面牆壁的結露情形。

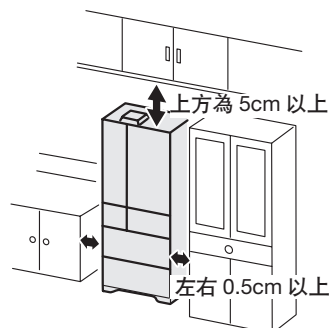

2

調整冰箱水平後固定。

- 1 手持單側的遮蔽架兩端，用力拉向身前方向將其卸下。

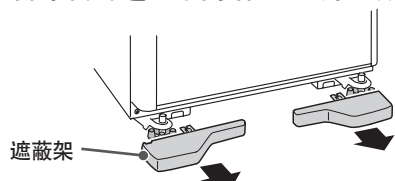

- 2 將調整墊放在調整腳的下方。
請將調整腳調整至前後左右平衡的狀態。

- 在放入調整墊之前，請將調整腳的底部與地板擦拭乾淨。若有髒污時將有可能會刮傷地板。

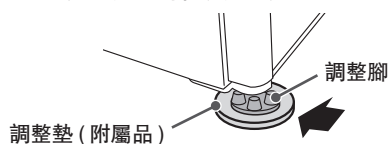

- 3 旋轉左右的調整腳，直到碰觸到地板。
調整冰箱的左右側門直到平行為止。

調整腳的旋轉量是，每旋轉 1 圈相當於箱門的高低差距 1mm。
請用專用工具配合調整腳的形狀並夾住。

■ 左側下歪

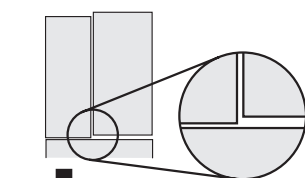

旋轉降低左邊的調整腳



■ 右側下歪

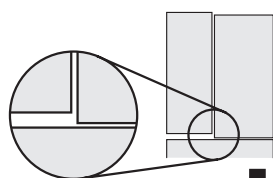

旋轉降低右邊的調整腳



- 旋轉調整腳時，請使用專用工具並請注意勿傷及地板。
- 當過度旋轉調節腳時，可能導致調節腳脫落。

請使用附屬專用工具及 2 個調整墊



通知事項

- 可能因地板材質的強度、食品的重量，在經過數日後（約 5 天）冰箱門往下降低。若發生此情形，請再次調整平行。
- 可能會因冰箱放置於非水平的場所，或是地板材質柔軟，因存放食品的重量而致冰箱腳下沉等原因，導致冰箱門左右產生高低差。
機能上沒有問題，如介意請按左側所列的步驟進行平衡調整。
- 進行左右水平調整，並使冰箱的前側稍微高一點可方便關門以避免門沒關好。
- 在冰箱門開啟的狀態下，手放開時，有可能冰箱門會慢慢自動關上，這並非故障。

- 4 請將遮蔽架的卡榫插入冰箱的安裝孔內安裝。

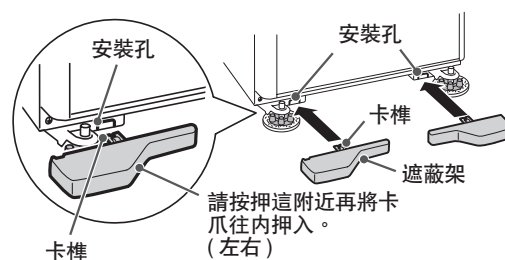

3

清潔冰箱內部 → 28~31頁

- 請用沾濕的柔軟布擦拭後，再以乾布擦乾。
- 請將給水槽、淨水濾網、製冰盤以清水沖洗。
- ※ 抽屜門的滑軌及滑軌接觸面上塗有潤滑劑，請勿擦拭。
(該潤滑劑是符合食品衛生法)
- ※ 剛開始使用時可能會有些許塑膠的氣味。
若特別在意時，為了讓該氣味不留存在室內，請保持室內通風良好。(使用後此氣味不久即消失)

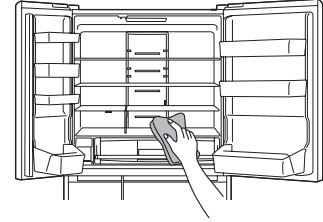

4

將電源插頭插入

設置後直接就可插上電源插頭。
請用獨立的插座。(電源 220 ~ 240V 額定電流 10A 以上)

- 請確認電源插頭及電線是否夾在冰箱背面及牆壁中間。為了防止電線發熱。

冰箱內開始冷卻

- 根據冰箱周圍溫度、食品的存放方式不同，冰箱內充分冷卻約需要 4 小時。夏天天氣炎熱時，也有可能需要 24 小時以上。在冰箱尚未充分冷卻前請勿將冰淇淋或未充分冷卻的食品、易受損的食品，放入冰箱。
- 初次使用自動製冰時，請操作自動製冰機的「製冰機清潔」。[→ 30頁](#)
- 自動進行連續的製冰運轉是必須在冰箱內充分冷卻之後才能開始。
(初次使用時，最初的結冰可能需要花 24 小時以上。)
- 當冰箱內溫度較低時，插入電源插頭後有可能經過 10 分鐘才開始冷卻。

通知事項

- 配管有可能需要加以防鏽處理。
當冰箱設置在溫泉地區、工業地區周圍、下水道管路附近等處，有可能受到硫化氣體的影響而導致配管的腐蝕。請向經銷店諮詢。若因氣體危害導致配管變黑或是故障時，不在保固對象之內。
- 將電源插頭插入後，會有馬達運轉聲音。此外，冰箱在達到充分冷卻之前，壓縮機及風扇可能會發出較大的聲音。
- 請勿將背面的標籤撕下，或拆卸側面下方的塑膠製品。
- 磁鐵裝飾或是吸盤吸附在冰箱雪櫃或冰箱門表面有可能會留下痕跡。
- 周圍溫度較高時，因冰箱門表面產生露水，貼在冰箱門的紙等，有可能會吸濕。

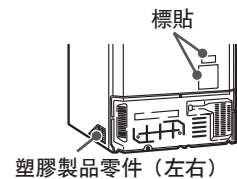

確認事項

各室的名稱・概略的溫度・存放食物

冷藏室 → 14頁
層架：約 2°C ~ 6°C 置物架：約 2°C ~ 9°C

日常使用的食品



箱門置物架附近溫度會稍高。

真空冰溫室 → 16頁

+1°C 約 0°C ~ 2°C **-1°C Off** 約 -2°C ~ 0°C

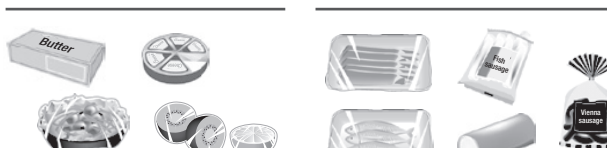

製冰室 → 18頁
約 -19°C ~ -17°C

貯冰空間
自動製冰機所製作的冰塊

【只有 R-ZX740K 型號, R-WX740K 型號】

小物品收納空間
保冷劑・冰棒等 → 19頁

上層冷凍室
→ 20頁
約 -19°C ~ -17°C



下層冷凍室
→ 20頁
約 -20°C ~ -18°C

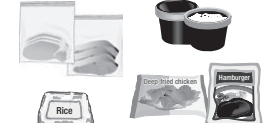
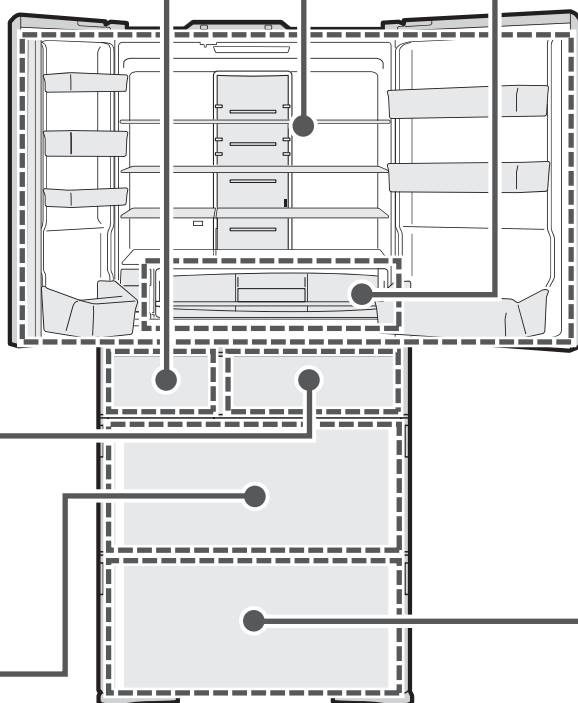



蔬果保鮮室 → 22頁

上層・下層存放空間：約 4°C ~ 8°C

上層存放空間 下層存放空間

使用過的蔬菜、小型蔬菜、水果等 葉菜類 (菠菜、小松菜等)、大型蔬菜 (高麗菜、萵苣等)



豎放儲存區：約 4°C ~ 9°C

豎放儲存區

較高大的蔬菜及寶特瓶



※ 是在環境溫度 32°C、冷藏室與冷凍室都設定為「■」、不放食物、關著門、溫度穩定時的目標溫度。
此外，這是未設定成「Sensor Cool」「Veg」時的溫度。

保存的訣竅

- 收納時請保留食品間的空隙。
- 建議您在存放強烈氣味食物時，先以保鮮膜包覆之後再放入冰箱。
- 可以收納食品重量的大概基準。 → 79頁

操作面板的功能

操作面板的上段為顯示部、下段為操作部。

顯示部及操作部通常為熄燈狀態。請觸按 **MENU** 鍵，讓其顯示亮燈。

操作部為觸控式面板。請觸按面板來切換設定。

確認事項

告知之顯示

eco	減少電力消耗，啟動運轉時顯示燈亮燈 → 26頁 [eco 運轉顯示]
🔒	操作面板按鍵鎖，上鎖時顯示燈亮燈 → 24頁
Auto Door	電動門功能在「開」的狀態時亮燈 → 12頁
Water	當給水槽中的水減少時，顯示燈亮燈 → 19頁 [告知給水警示]
Door	冰箱門開關次數多時則顯示燈亮燈 → 26頁 [冰箱門開閉顯示]

※ 為了更清楚說明，所有的顯示都呈燈亮的狀態。

顯示部分

- eco
- Auto Door
- Water
- Door Save

操作部

- Quick
- Sensor Cool
- On
- Spot Cool
- Off
- Veg
- Off
- +1°C
- 1°C

最初碰觸 MENU 鍵

- Energy Saving (Button Lock Press 3 Sec.)
- Freezer (Auto Door Press 3 Sec.)
- Fridge
- Ice Maker (Cleaning Press 5 Sec.)
- Powerful (Sensor Cool Press 3 Sec.)
- Vacuum

節電設定

將各室的冷卻減弱，節省電力。

Save (節電) → 27頁

溫度設定

平常請設定在「■■■」的位置。

冷藏室 → 14頁

冷凍室 → 21頁

製冰設定

Quick (急速製冰) → 19頁

On (製冰) → 18頁

Off (製冰停止) → 19頁

設定冷卻模式

Sensor Cool (即鮮冷藏) → 15頁

Spot Cool (急速冷藏) → 15頁

Veg (蔬果室強) → 22頁

真空冰溫室設定

+1°C → 17頁

-1°C → 17頁

Off (關) → 17頁 (非真空的冰溫)

通知事項

- 觸按 **MENU** 鍵時，所有顯示亮燈後，即顯示目前的設定狀態。此外，打開冷藏室門，亦可顯示目前的設定狀態。
- 操作結束後，再次觸按 **MENU** 鍵時，顯示部及操作部的顯示會熄燈。
此外，縱使不觸按 **MENU** 鍵，經過約 40 秒，為節省電力，顯示部及操作部的顯示會自動熄燈。
但，設定成「節電」模式時，「Quick」的運轉顯示及「Off (製冰停止)」、「Water」、「Off (關)」的顯示、環保節能運轉中的 [eco 運轉顯示] [冰箱門開閉顯示] 不會熄燈。
- 打開冷藏室門時，顯示部及操作部會亮燈。關上冷藏室門約 15 秒後則熄燈。
- 觸控面板會根據周圍的溫度、濕度、使用者的身體狀態及旁邊的電器製品的使用狀況，其反應會有所變化。
- 按了也沒有反應 (顯示內容不變) 的時候，請把手指離開一下再按。兩次按按鈕的時間間隔過短有可能導致檢測出錯誤訊息 (感應為持續按)。用力按也不會改善感應度的。
- 操作部濕或髒了的時候，會沒有反應。請用沾濕的布將髒污擦拭後，再以乾布擦乾。
- 冷藏室門打開時，或顯示部閃爍時觸按操作部則不會有任何反應。請確認顯示部閃爍的 → 35頁。

電動門

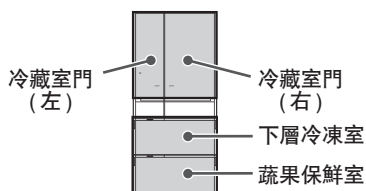

■ **電動冷藏室門** 使用電動冷藏室門功能，只要以手指輕輕觸碰，即可輕鬆地開啟冷藏室門。
(只有 R-ZX740K 型號)

■ **電動抽屜** 使用電動抽屜功能，縱使存放了許多食品，重量相當重，也能輕輕鬆鬆的取出。



警告

- 如果幼兒可能玩耍電動冷藏室門或電動抽屜時，請停止使用電動門功能。



注意

- 如果幼兒可能玩弄電動門時，請停止使用電動門功能。
- 如果有人人在冰箱前，請勿操作電動冷藏室門。
(可能會因撞到打開的冷藏室門，而造成意想不到的傷害)
- 當你按下蔬果保鮮室的電動抽屜開關時，腳請勿靠近冰箱。
(避免開啟箱門時撞到腳而受傷)
- 冰箱上面請勿放置物品。
- 請勿握持箱門把手以外的部分關閉箱門 (可能造成因冰箱門夾住手指而受傷的情形)
- 請勿以膝蓋等碰觸電動抽屜開關。

電動冷藏室門
操作部 (自動)

電動開門器

電動抽屜開關
(自動)

把手 (手動)

把手 (手動)

把手 (手動)

設定電動門

電動門的功能可切換成「開」(動作)或「關」(停止)。購買時設定為「開」。

1

按下操作面板的 **MENU** 按鍵，顯示燈亮

顯示燈全部燈亮後，顯示目前的所有設定。

2

持續按下 **Freezer** 按鍵
3 秒以上，直到發出
設定音 (嗶 -)，讓
「Auto Door」顯示
燈亮

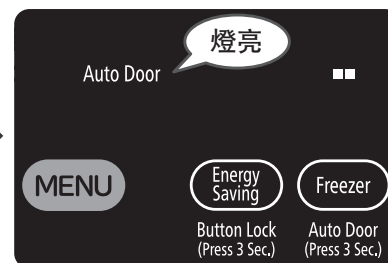
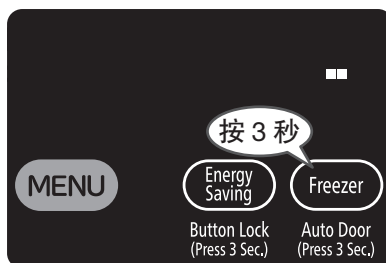

(購買時、設定時)

解除

按下操作面板的 **MENU**，讓顯示亮燈，持續按下 **Freezer** 按鍵 3 秒以上，直到發出設定音 (嗶嗶)，讓「Auto Door」顯示熄燈

通知事項



- 請在電動門「關」的狀態下，手持把手，打開抽屜。
- 電動冷藏室門或電動抽屜，無法讓單一的電動門機能停止。

使用電動冷藏室門

當觸碰電動冷藏室門操作部，發出操作音，門自動開啟。

敬請依照指示操作

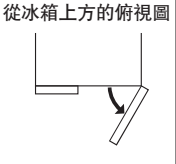
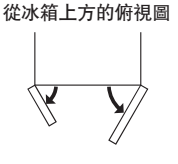
關閉時，以手握住手把關閉冷藏室門。
電動無法關閉。

電動冷藏室門的開啟方式	開啟單一邊冷藏室門  從冰箱上方的俯視圖	一次開啟兩邊的冷藏室門  從冰箱上方的俯視圖
操作方法	觸碰開啟的冷藏室門的操作部 ※ 請用手指操作。 	以手指在操作部的一端滑動到另一端 (依順序開啟操作的冷藏室門) 
電動冷藏室門的操作音	嗶	嗶—

電動門

通知事項

- 「製冰室」、「上層冷凍室」的任何一個在開啟的狀態下時，為了防止手被夾傷，電動冷藏室門無法操作。
- 電動冷藏室門是為了減輕開啟冷藏室門的負擔所設計的功能。隨著冰箱的設置條件、冰箱門置物盒內飲料食品的收納狀況，電動冷藏室門開啟的角度可能有所改變，或在開啟之後會有稍微關閉的情形，這並非異常。
- 當碰觸電動冷藏室門操作部後，冷藏室門在開啟的動作時會發出聲音，這並非異常。
- 當電動冷藏室門的操作部濕或髒時，有可能冷藏室門沒有反應。請以沾濕的布將污垢擦拭之後，再以乾布擦拭乾淨。
- 同時觸碰電動冷藏室門操作部周邊，持續約 1 秒以上時，冷藏室門有可能無法開啟。
- 當電動冷藏室門功能停止時，請以手握把手開啟冰箱門。

以手動開啟冷藏室門

開啟冰箱門時

- 請勿握住旋轉隔板部開啟冰箱門。
(可能造成冰箱門無法開啟)

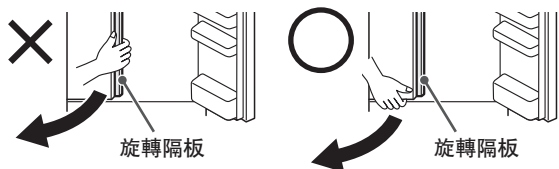

關閉冰箱門時

- 當旋轉隔板為立起的狀態時請勿關閉冰箱門。
(可能造成冰箱門無法完全關閉)

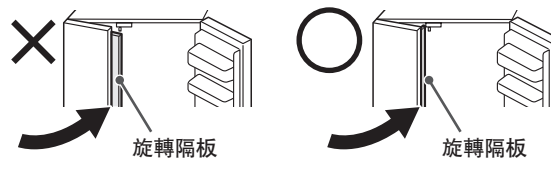

敬請依照指示操作

打開冰箱門時，請勿用力過猛，或是靠著打開的冰箱門等，施加外力。有可能造成冰箱門的損壞。

使用電動抽屜

用手按下電動抽屜開關，抽屜就會開啟。

敬請依照指示操作

關閉時，請以手動將左右把手推進。
電動無法關閉。

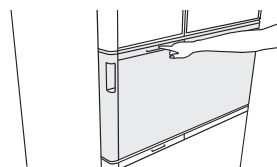

通知事項

- 為了減輕拉出抽屜時的負擔所設計的功能，開始動作時，推出抽屜的尺寸約在 15cm 以上。因冰箱設置條件不同，有可能拉出抽屜的尺寸稍微不同，或是門以電動的方式開啟後又稍微退回，這些都不是異常現象。
- “下層冷凍室”和“蔬果保鮮室”不能同時用電動開啟。
- 當“下層冷凍室”和“蔬果保鮮室”中任何一方被開啟，電動抽屜功能將不能操作。
- 當你按下電動抽屜開關時，可聽見聲響。這不是異常。
- 電動抽屜按鍵上若沾上食品液體時，請立即擦拭乾淨。
會造成電動抽屜按鍵機構部的故障，或是抽屜門無故地開啟的原因。
- 當電動抽屜功能停止時，請以手握左右把手開啟抽屜。

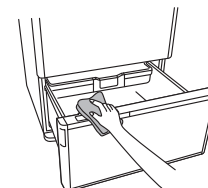

冷藏室

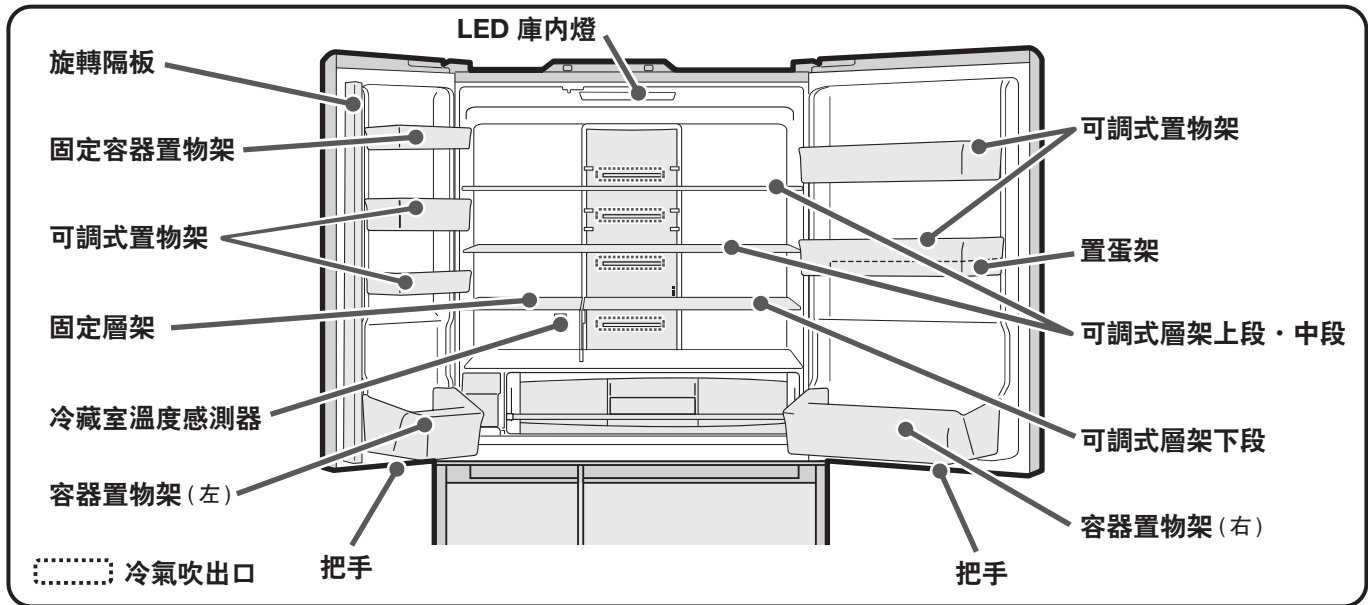
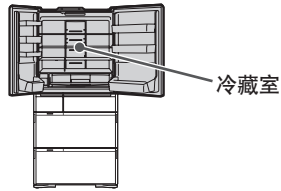

敬請依照指示操作 ● 若將水分較多的食品或罐裝飲料，放置在冷氣吹出口前，有可能結凍或破裂，請勿將該類食品放置在冷氣吹出口前。特別是設定成「Sensor Cooling」時，更容易結凍。將食品加蓋或包裹保鮮膜，可以防止食品的結凍。

調節溫度

購買時，設定成「■■」。通常時，請設定為「■■■」。若夏天，感覺冷度不夠時，請設定為「■■■■」。

1 按下操作面板的 **MENU** 按鍵，顯示燈亮
顯示燈全部燈亮後，顯示目前的所有設定。

2 按下 **Fridge** 按鍵，可以變更適當的溫度



冷藏室的概略溫度
「■■■■」比「■■■」溫度低 1 ~ 3°C
「■」比「■■■」溫度高 1 ~ 3°C

敬請依照指示操作 ● 在冬天 長時間設定為「■■■■」時 食品有可能因而結凍。若覺得冰箱內太冷時 請設定為「■■■」或是「■」。

通知事項

- 溫度因使用條件而有所變動。
- 調節更細微的溫度時 → 24頁
- 將冷凍室溫度設定為「■■■■」，比設定為「■■■」時，消耗電力約增加 20%。
- 當變更冷藏室的溫度設定時，真空冰溫室的溫度也隨之改變。

調整置物架・層架的高度

配合食品或飲料的大小，置物架及層架的位置可以做適度的調整。關於拆卸方式・安裝方式請參閱。→ 32頁



注意

■操作玻璃層架時

- 請勿對玻璃層架施加強力的撞擊。(玻璃層架可能因破裂而導致受傷)
- 因玻璃層架較重，安裝，卸除時請特別小心。

■ 可調式層架上段・可調式層架中段・可調式層架下段・可調式置物架

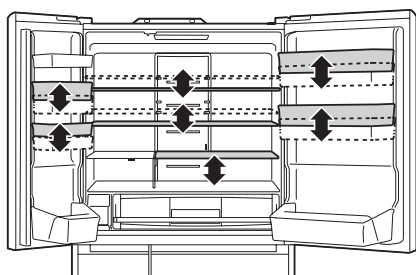

R-ZX740K 型號
R-WX740K 型號
R-WX620K 型號

● 剛購買時的狀態

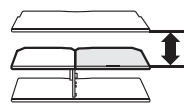

● 收納鍋子等

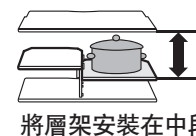

● 收納紙盒裝牛奶等

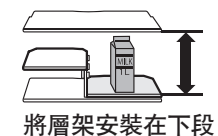

R-WX670K 型號

● 剛購買時的狀態

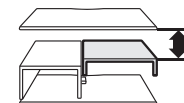

● 收納鍋子等

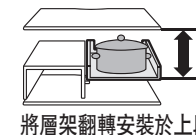

● 收納紙盒裝牛奶等

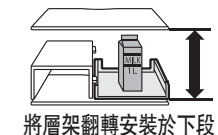

讓食品更低溫保存時 (使用「Sensor Cooling」功能)

「Sensor Cooling」有兩種功能。

- 讓「低溫冷藏空間」更低溫。(解除時：約 2 ~ 6°C ⇒ 設定時：約 0 ~ 3°C)
建議用來保存預做的配菜。
- 將溫熱的食品放置在「自動急冷卻空間」時，感測器會感測到食品的溫度，則自動轉換成急冷卻。
縱使放入溫熱的鍋子等容器，可抑止對其他食品的影響，可以縮短冷卻的時間。
當要保存溫熱食品時，請放冷至能以手碰觸的溫度 (50°C 以下) 之後再放入。防止燙傷或層架變形。

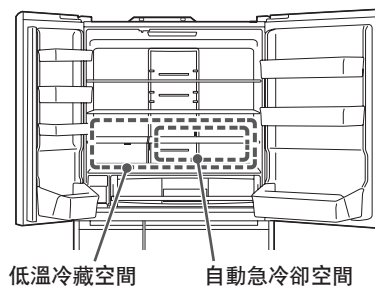

通知事項

- 設定成「Sensor Cooling」時，會同時設定「低溫冷藏」及「自動急冷卻」兩個功能。無法設定任何一方的單一功能。
- 設定成「Sensor Cooling」時，會比解除時所消費更多的電力。此外，有可能運轉聲音會變大。
- 設定成「Sensor Cooling」時，容器置物架的溫度會比解除時低。
- 冷藏室設定為「■」或是「Save」時的溫度，冷藏室整體的溫度比「■■■」要高 1 ~ 3°C。
設定為「■■■」時，冷藏室整體的溫度約 0 ~ 3°C。
- 在「自動急冷卻」狀態時，依食品的量及溫度不同，有可能感測器無法感測到食品的溫度，設定成「Sensor Cooling」時，低溫冷藏空間因為會更降低溫度，可以縮短冷卻的時間。
- 「低溫冷藏空間」的溫度，是周圍溫度 32°C，冷藏室、冷凍室都設定成「■■■」時，安定狀態下的概略溫度。

設定方法

1 按下操作面板的 **MENU** 按鍵，顯示燈亮
顯示燈全部燈亮後，顯示目前的所有設定。購買時設定成「關」的狀態。

2 長按 3 秒以上直到 **Powerful** 的設定音發出 (嗶—)，讓「Sensor Cool」亮燈。
至解除之前「Sensor Cool」仍有效。

解除 按下操作面板的 **MENU**，讓顯示亮燈，長按 3 秒以上直到 **Powerful** 的設定音發出 (嗶嗶)，讓「Sensor Cool」熄燈。

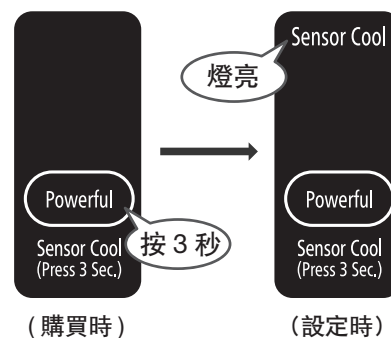

冷藏室

想要急速冷卻食品時 (使用「Spot Powerful Cooling」功能)

想要急速冷卻食品時，進行「自動急冷卻空間」的加強冷卻效果的運轉。
可縮短有溫熱食品的冷卻或加熱調理後餘熱放涼的時間。
建議使用在要外出前，在短時間內將便當、飲料、加熱調理後的蔬菜冷卻卻。
當要保存溫熱食品時，請放冷至能以手碰觸的溫度 (50°C 以下) 之後再放入。
防止燙傷或層架變形。

- 通知事項**
- 設定為「Spot Powerful Cooling」時會比解除時消耗更多的電費。
 - 若連續使用「Spot Powerful Cooling」時，冰箱內的食品有可能會結凍。
 - 在設定成「Sensor Cooling」時也可以使用。

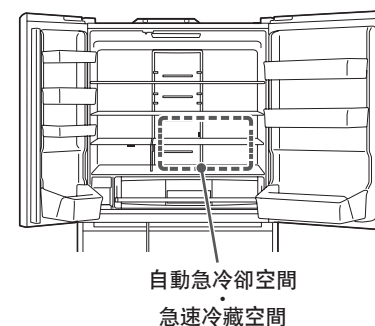

設定方法

1 按下操作面板的 **MENU** 按鍵，顯示燈亮
顯示燈全部燈亮後，顯示目前的所有設定。購買時設定成「關」的狀態。

2 按下 **Powerful** 按鍵，「Spot Cool」顯示燈亮
運轉約 60 分鐘後自動結束，「Spot Cool」的顯示即熄滅。

中途解除 按下操作面板的 **MENU** 按鍵，顯示燈亮按下 **Powerful** 按鍵「Spot Cool」顯示燈熄滅

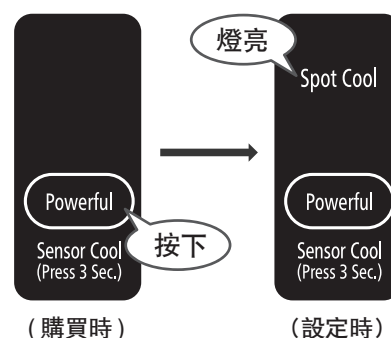

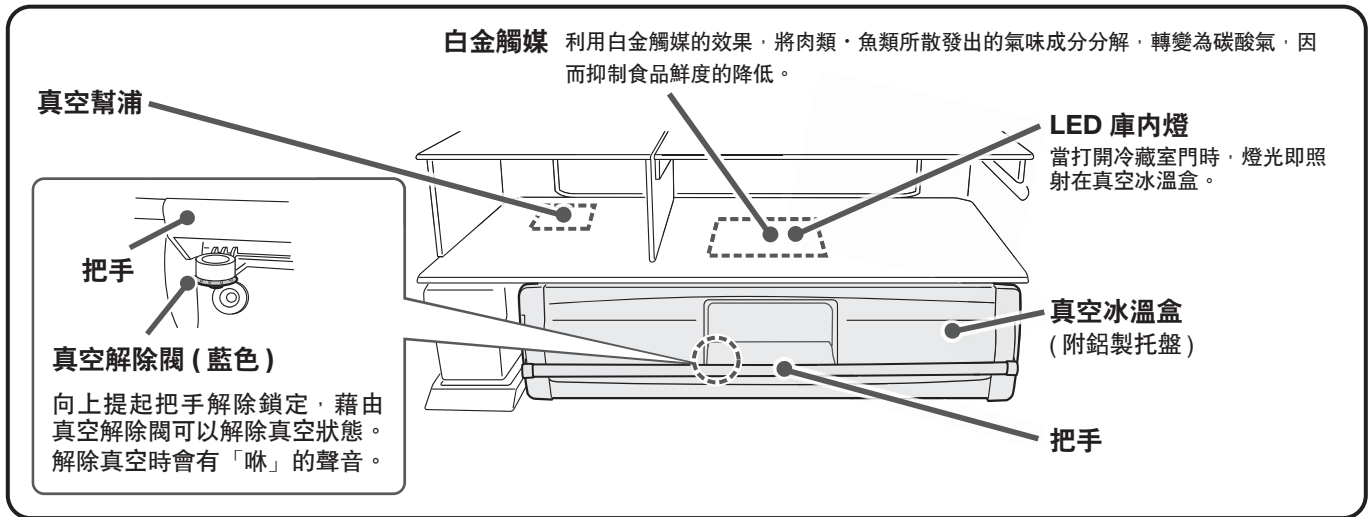
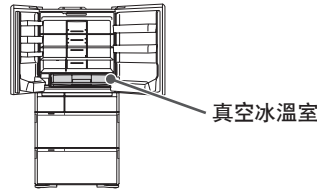

真空冰溫室



區分使用的要點

請配合收納的食品，切換成「+1°C」或「-1°C」。※購買時，設定成「-1°C」。

<p>+1°C (約 0°C ~ 2°C)</p>	<p>●乳製品</p> <p>●切好的蔬菜、水果</p> <p>●結凍時會造成品質、口感變差的食物</p> 
<p>-1°C (約 -2°C ~ 0°C)</p>	<p>●肉類・加工肉品</p> <p>●魚貝類・海鮮類・魚類加工食品</p> <p>●肉類、魚類的解凍</p>  <p>・水分多的食品，可能會結凍。</p>
<p>Off (約 -2°C ~ 0°C)</p>	<p>真空功能停止運作。建議存放需裝在「密封袋」、「密封容器」的食物時選擇該模式。因為是冰溫室，含水分較多的食物可能因低溫而凍結。</p>

通知事項

- 縱使食品以保鮮膜包覆，也不會改變真空的效果。若擔心氣味轉移至其他食品時，請以保鮮膜包覆。

注意事項

- 周圍溫度低時，水分較多的食物可能因低溫而凍結。
- 將冰溫與冷凍的食材一起放入時，為了防止凍結，請將溫度設定為「+1°C」
- 將冷藏室、冷凍室的溫度設定調至「■■■■」或是「■」時，真空冰溫室的溫度會稍有改變。
- 請勿將過多的食品或容器塞入真空冰溫室。可能會導致真空冰溫抽屜無法拉出。

變更真空冰溫室的設定

1 按下操作面板的 **MENU** 按鍵，顯示燈亮

顯示燈全部燈亮後，顯示目前的所有設定。

2 按下 **Vacuum** 按鍵，可依照個人喜好變更設定

按下按鈕時依下列的順序切換。購買時設定為「-1°C」。

- 注意事項**
- 當設定為「Off」時，「Off」的顯示持續亮燈。為達到省電目的，約 40 秒顯示燈即熄燈，所設定的功能將持續有效。

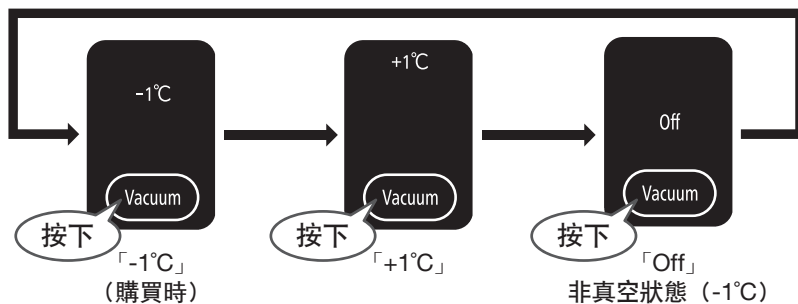

※周圍溫度32°C沒有放入食物，冰箱門關閉的狀態，在安定時的真空冰溫室的約略溫度。

真空冰溫室

開閉真空冰溫室門

開啟箱門時

1 將把手往上扳起，解除鎖定

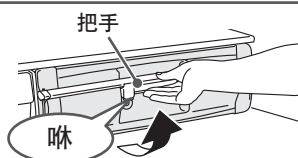

- ※ 真空幫浦啟動後至達到真空狀態，約需 3 ~ 4 分鐘。在 4 分鐘以內打開真空冰溫室，有可能沒有“咻”的聲音。
- ※ 在沒有同時開啟左右冰箱門的狀態下拉出真空冰溫室時，可能造成零件的破損。

2 將真空冰溫室往前拉出

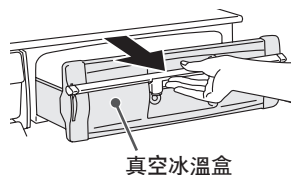

- ※ 若能聽到“咻”的聲音時，因為是正在解除真空的狀態，無法拉出真空冰溫室。請在聲音消失後再往前方拉出。

關閉箱門時

1 將真空冰溫室往內推進

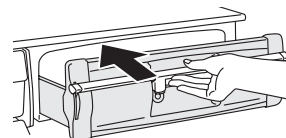

2 將把手往下扳，讓其鎖定

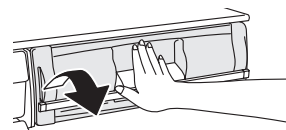

注意事項

- 若沒有將手把確實地往下扳，則無法形成真空狀態。
- 在未鎖定把手的狀況下關上冷藏室門，則可能造成零件、食品的破損，或是門縫間產生間隙，造成無法充分冷卻的原因。

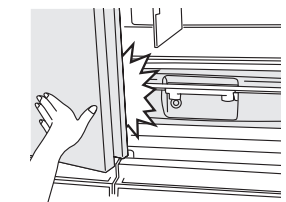

敬請依照指示操作

- 若密封墊緊貼著，則無法維持密封狀態。若緊貼時，請將其剝離。因為左右面及下面無法看清楚，請將真空冰溫室拆卸後進行確認。→ 32頁
- 因為真空冰溫室是密閉的狀態，食品和空氣中所含的水分，有可能在冷凍室內結成水滴或結霜、結冰，請以柔軟的布沾溫水擦拭。(產生水滴或結霜、結冰時，並不會對冷卻性能造成影響。)
- 若您在意食品上有水滴、霜、結冰，建議您在存放食品時，以保鮮膜包裹。
- 真空冰溫室內若水或食品的液汁溢出時，請立刻擦拭乾淨。
- 白金觸媒不須要更換。請勿將其拆除。

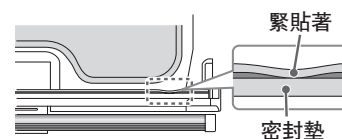

水滴、結霜、冰



製冰室 (自動製冰機)

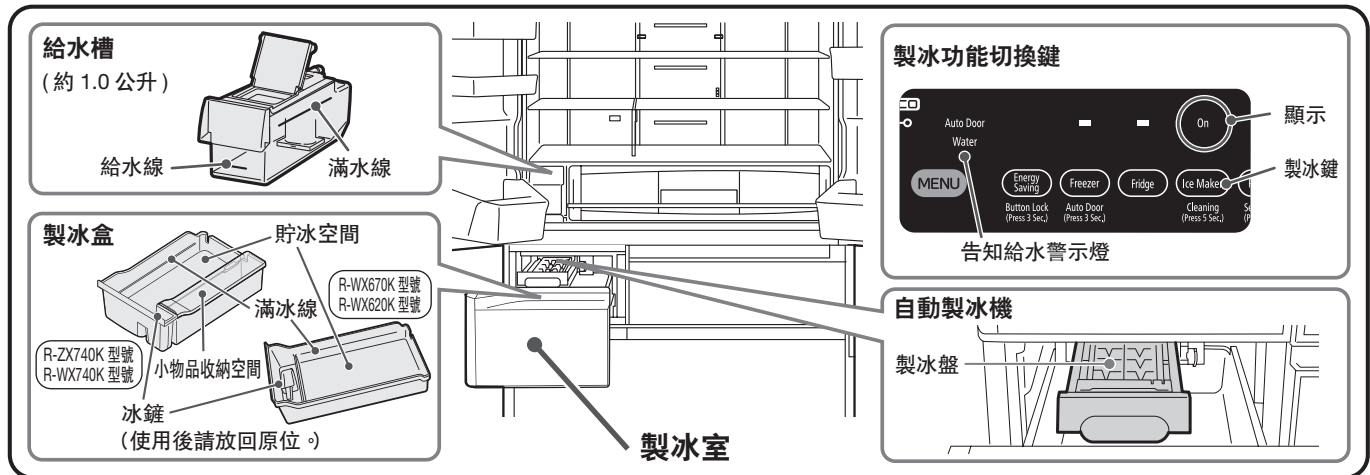
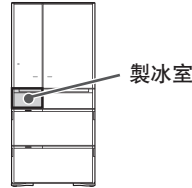

製冰方法

初次製冰時、或是一星期以上沒有製冰時，請操作「製冰機清潔」。 → 30頁

1 按下操作面板的 **MENU** 按鍵，顯示燈亮

顯示燈全部燈亮後，顯示目前的所有設定。

2 按下 **Ice Maker** 按鍵，「On」顯示燈亮

購買時，設定為製冰「開」(燈亮)的狀態。



3 取出給水槽

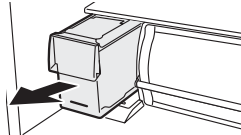

4 打開給水槽蓋加水

※ 請勿加水至滿水線以上。

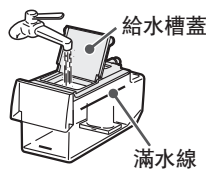

5 再裝回給水槽

往前推入到超過「水槽安裝位置」的線位。

若給水槽沒有確實押入底部，則無法製冰。

※ 給水槽傾斜會將水灑出。水灑出請立即擦乾。

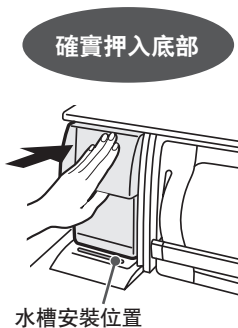

6 自動開始製冰運轉

- 當冰塊積滿至滿冰線時，則會暫時停止製冰功能。當冰塊減少時，會自動啟動製冰功能。
- 當製冰盒內的沒有冰塊時，從製冰盤掉落冰塊，可能會有較大的聲音。

敬請依照指示操作

- 注意：只可加入飲用水。
- 製冰用水根據貴國的飲用水標準而定。自來水的水質因不同國家而異。請向地方當局檢查、核實。
- 因衛生上的理由，請至少每週更換一次水，並清洗容器。
- 31頁
- 使用含豐富礦物質的礦泉水製作冰塊時，會產生白色的粉末，這是礦物質成分，對人體無害。
- 如下列所示，因為容易受到細菌污染，平常請三天清洗容器一次。

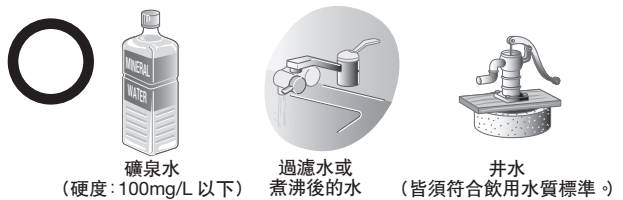

- 由於會導致故障，或是會造出畸形、連體的冰等，請不要使用這些(液體)。



收納量・製冰時間

型號		R-ZX740K 型號, R-WX740K 型號, R-WX670K 型號, R-WX620K 型號
冰的收納量	正常運轉	約 90 個
	將冰塊整平	約 150 個
一次 (12 個) 的製冰時間	通常的「On」	約 110 分 ~ 140 分
	「Quick」	約 80 分

※ 周圍溫度 30°C，各冰箱的溫度設定在「■■■」的位置，無開關冰箱門狀態的約略值。

通知事項

- 若留有部分的冰塊，因儲冰量較少，則可能無法製冰。請將冰塊整平。
- 下列的情形時，可能會延長製冰的所需時間。

- 開始使用時 (可能需要 24 小時以上)
- 設定成「節電」模式時
- 清潔製冰盤後
- 冷凍室溫度設定為「■■■」時
- 停電時
- 冷凍室或製冰室門呈半開的狀態
- 冰箱內同時放進大量食物時
- 冰箱門開關次數頻繁時
- 冬天周圍溫度較低時

敬請依照指示操作

- 設定成「On」「Quick」時，貯冰空間，除了自動製冰機所製造的冰塊之外，請勿放入其他的冷凍食品。(有可能造成無法製冰、或因食品接觸到製冰機的零件而導致門無法開啟、零件破損等情形。)
- 請慢慢的開關製冰室門。若開關時用力過猛，冰塊可能從製冰盒掉落至下層冷凍室。

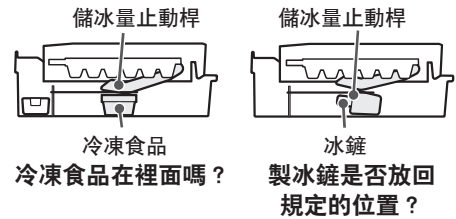

製冰室 (自動製冰機)

急速製冰

1 按下操作面板的 **MENU** 按鍵，顯示燈亮
顯示燈全部燈亮後，顯示目前的所有設定。

2 按下 **Ice Maker** 按鍵，**「Quick」** 顯示燈亮
比「On」更縮短製冰時間。
一次製冰約可製 12 個冰塊。
約 7 小時「Quick」的運轉則自動停止，切換至「On」模式。

通知事項

- 「Quick」在運轉中時「Quick」的顯示燈亮燈。[eco 運轉顯示燈] 則熄滅。
- 由於「Quick」運轉時優先冷卻冷凍室，因此冷藏室門開關次數頻繁時，冷藏室的溫度容易上升。

製冰停止

1 按下操作面板的 **MENU** 按鍵，顯示燈亮
顯示燈全部燈亮後，顯示目前的所有設定。

2 按下 **Ice Maker** 按鍵，**「Off」** 顯示燈亮
※ 一星期以上「Off」時，自動製冰機則需進行清潔。→ 30, 31 頁

通知事項

- 「Off」在運轉中時「Off」的顯示燈亮燈。

小物品收納空間 (只有 R-ZX740K 型號, R-WX740K 型號)

收納食品 保冷劑・冰棒等

通知事項

- 當放入稍有熱度的食物時，貯冰空間的冰塊融化，可能延長製冰的時間。
- 因為是間接冷卻，冰淇淋有可能變軟。
- 請務必將蓋子蓋上後使用。請勿放入蓋子無法關緊的大件物品。

告知給水警示燈

給水槽的水量減少時，**Water** 顯示燈亮。請補充水至給水槽內。

開關冰箱左側箱門時，**Water** 的顯示會暫時熄滅。若沒有補充水的情況，顯示會再次亮燈。(最長是 3 小時後)

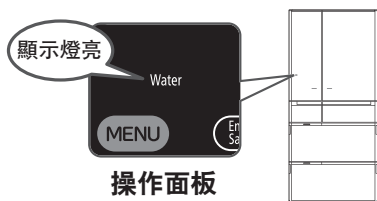

通知事項

- 自動製冰機設定為「Off」時，**Water** 不會顯示燈亮。
- 即使給水槽中有水，但是安裝給水槽時沒有確實推入，**Water** 會顯示燈亮。此時請確實地將給水槽往前推入至固定位置。
- 設定成「On」時，當滿冰的狀態時，有可能 **Water** 的指示燈不會亮燈。

「On」或 **Freezer** 「■■■■・■」及 **Fridge** 「■」閃爍時

製冰盤有可能碰到製冰盒內的食物。

請將製冰盒內清空，然後操作「製冰機清潔」。→ 30 頁



冷凍室

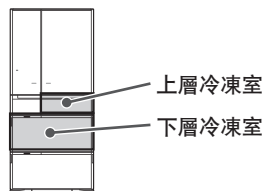

上層冷凍室

請將日常使用的食品或使用過的食品保存於此。

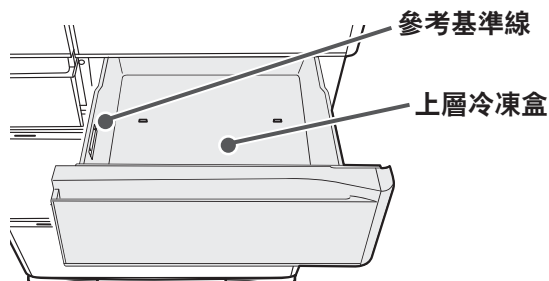

注意事項 ● 食品存放時請勿超過參考基準線。

下層冷凍室

內配 3 層冷凍盒，能夠充分地存放，整齊地收拾。

適於存放需長期保存的東西，容易融化的冰淇淋等。

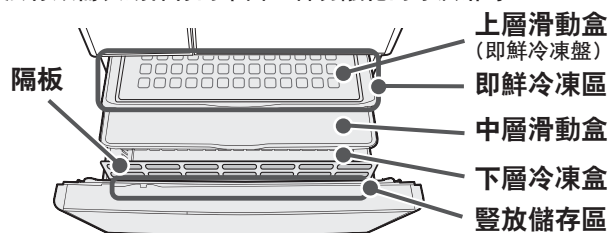

注意事項 ● 請勿拆下上層滑動盒與隔板。

收納食品

上層冷凍室		冷凍包裝、密閉容器、吐司麵包等
下層冷凍室	上層滑動盒	小件物品、冷凍食品等 即鮮冷凍區 肉類、魚類、白飯急速冷凍時
	中層滑動盒	冷凍包裝、密封容器等
	下層冷凍盒	冷凍食品、麵包、冰淇淋等 豎放儲存區 存放冷凍專用寶特瓶等

收納食品時

請配合食品的種類、大小來收納。收納食品的高度，請以上層冷凍盒為參考基準，其他的置物盒請以端面為基準。

收納食品時，請勿觸及上面的收納盒或隔板。

可能因箱門沒有完全關緊，而造成不夠冷的情形。此外，也可能造成食品、盒子破損的情形。

注意事項

- 上層滑動盒裡請勿存放塑膠瓶。塑膠瓶凍結後會膨脹，導致中層滑動盒拉不出來。
- 請勿將中層滑動盒拆下。食品會掉落到下層冷凍盒的後面，導致門無法關緊。
- 請只使用於存放冷凍對應的寶特瓶類及能夠冷凍的食品。

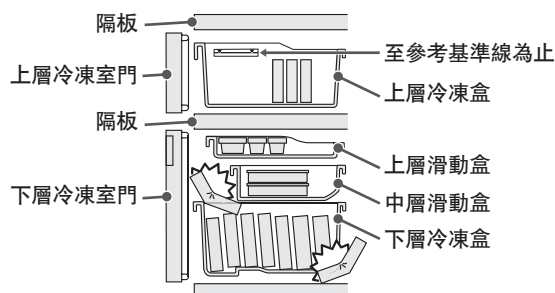

調節溫度

購買時，設定成「■■」。通常時，請設定為「■■」。若夏天，感覺冷度不夠時，請設定為「■■■」。

1 按下操作面板的 **MENU** 按鍵，顯示燈亮

顯示燈全部燈亮後，顯示目前的所有設定。

2 按下 **Freezer** 按鍵，可以變更適當的溫度



冷凍室的概略溫度
「■■■■」比「■■■」溫度低 2 ~ 4°C
「■」比「■■■」溫度高 2 ~ 4°C

敬請依照指示操作

- 若覺得冰箱內太冷時，請設定為「■■■」或是「■」。

通知事項

- 溫度因使用條件而有所變動。
- 調節更細微的溫度時 [→ 24頁](#)
- 將冷凍室溫度設定為「■■■■」，比設定為「■■■」時，消耗電力約增加 20%。
- 當變更冷凍室的溫度設定時，製冰室的溫度也隨之改變。

冷凍室

使用即鮮冷凍

搭配大型鋁製托盤的效果，可更快速的冷凍食品。

將食品放置在即鮮冷凍區，感測器可以感測食品的溫度，自動切換冷卻運轉。

請將食品用保鮮膜或夾鏈袋包覆後放置在鋁製托盤上。

若將食品分小包裝，不僅可快速冷凍至中心部，也便於拿取，相當方便。

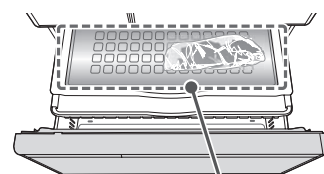

即鮮冷凍區

通知事項

- 若將食品不重疊地緊貼大型鋁製托盤地放置，則能夠更加有效地冷凍。

蔬果保鮮室

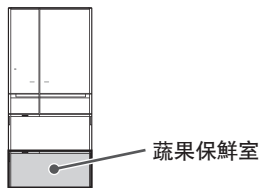

白金觸媒 將食品所散發出的氣味成分、蔬菜所散發的乙烯氣分解，轉變為碳酸氣，因而抑制食品鮮度的降低。

隔板 ※ 請勿將其拆除。
(只有 R-ZX740K 型號, R-WX740K 型號)

密合扣 (內含白金觸媒)
※ 請勿將其拆除。

上層滑動盒

下層置物盒

隔板
※ 請勿將其拆除。

蔬活保濕裝置
※ 請勿將其拆除。

潤澤護蓋
※ 請勿拆除或強硬移動

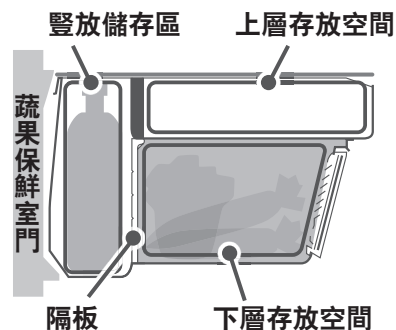

收納食品

上層存放空間	未使用完的蔬菜、小型蔬菜、水果等
下層存放空間	葉菜類 (菠菜、小松菜等)、大型蔬菜 (高麗菜、高苜等)
豎放儲存區	較高大的蔬菜 (黃瓜、蘆筍等) 及 2 公升的寶特瓶

蔬果保鮮室的溫度調節 (蔬果室強)

1 按下操作面板的 **MENU** 按鍵，顯示燈亮

顯示燈全部燈亮後，顯示目前的所有設定。

2 按下 **Powerful**，「Veg」的顯示燈亮

以比平常更低的溫度來保存。(平常約 4 ~ 8°C → 「Veg」約 2 ~ 6°C)

※ 是冰箱周圍溫度 32°C，冷藏室、冷凍室的溫度都設定在「■■■」，且不放入食品關閉冰箱門，安定運轉時的大致溫度。

注意事項 ● 為了省電，顯示在 40 秒後熄燈，直到操作解除動作，持續原本之設定。在設定為「Veg」時，[eco 運轉顯示燈] 不點亮。

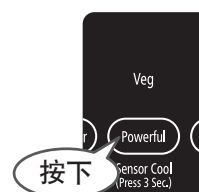

解除 按下操作面板的 **MENU**，顯示燈亮後，再按下 **Powerful** 「Veg」的顯示燈熄滅

通知事項

- 長時間使用「Veg」功能時，含水分較多的蔬菜有可能會結凍。
- 在「Veg」模式中，設定成「節電」模式的情形時，冷卻效果會由「Veg」轉向較弱的冷卻效果。 → 27頁
- 當外面溫度較低時，蔬果保鮮室內的溫度可能會變低。

敬請依照指示操作

- 若有以下的情形，請解除「Veg」的設定。
- 茄子等對低溫較弱的蔬菜的表面呈現凹陷、變色的情形。
 - 蔬果保鮮室有結露的情形。

收納食品時

請配合食品的種類、大小來收納。

- 請注意收納食品的高度。
 - 冰箱門無法確實關緊，可能造成冷卻效果變差。此外，也可能造成食品、盒子、潤澤護蓋的破損。
 - 因寶特瓶的種類不同，有可能過大而致無法收納。
- 請勿將上層滑動盒卸除的狀態下使用。
 - 食品可能會掉落到滑動盒的內側，可能而導致門無法關緊。
- 請勿將過量的食品、飲料等強硬塞入。
 - 可能造成隔板、潤澤護蓋的破損。

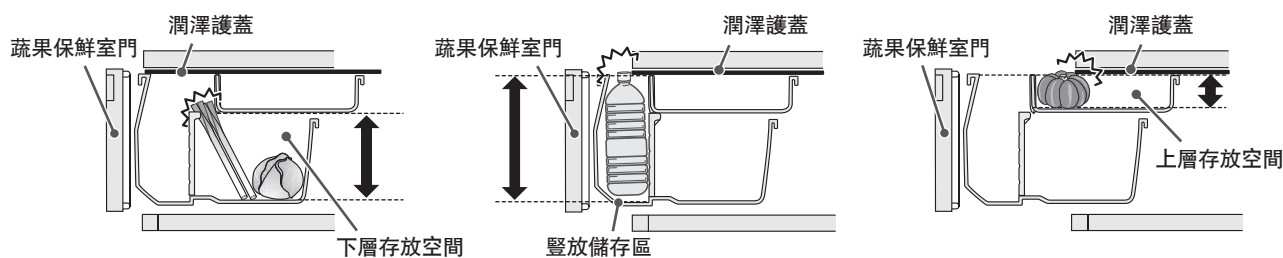

蔬果保鮮室

蔬菜保存要領

■建議常溫保存的蔬菜

- 大蒜、洋蔥、馬鈴薯、番薯和南瓜（圓形）保存在陰冷的場所（室內保持恒定低溫且不受陽光直射的場所）

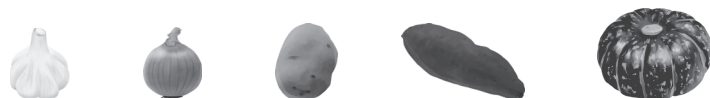

■可能發生低溫障害

長期放在蔬果保鮮室內，因食品種類而異，可能會變色，風味減低。此外，也有可能維他命 C 含量減低、發霉、腐敗。

- 蔬菜…蕃茄、青椒、黃瓜、茄子、四季豆、地瓜、秋葵等
- 水果…香蕉、鳳梨、芒果、木瓜、酪梨、檸檬等



食用之前請短時間放置在冷藏庫冷卻。

敬請依照指示操作

- 收納較少蔬菜時，因為無法保持較高的溼度，請用保鮮膜包裹後再存放。
- 因為蔬果保鮮室的濕度較高，依蔬菜的量及種類不同，可能在置物盒、潤澤單元表面、潤澤護蓋、食品表面有結露的情形。若在意結露的情形，請用保鮮膜包裹食品。
- 可能因食品包裝袋及容器阻塞蔬活保濕裝置，會發生更多的結露情形。請將阻塞在蔬活保濕裝置的食品包裝袋及容器移至其他地方。
- 置物盒內若留存水分，食品容易受損，請用乾布將水分擦拭。
- 將米、海苔等的乾燥食品放置在蔬果保鮮室收納時，請裝入密閉的容器（袋）後再收納於蔬果保鮮室內。乾燥食品容易吸收溼氣。

通知事項

豎放儲存區比其他空間的溫度稍微高。

各種功能

溫度微調節 (冷藏室・冷凍室)

冷藏室和冷凍室的溫度設定可以更細分為 11 個階段。

1 開啟下層冷凍室門

2 按下操作面板的 **MENU** 按鍵，顯示燈亮

顯示燈全部燈亮後，顯示目前的所有設定。

3 持續按住 **Fridge** 按鍵 5 秒以上，直到發出嗶聲為止

4 關閉下層冷凍室門

5 按下 **Fridge** 或 **Freezer** 按鍵，可調節各室的溫度。

按下按鍵，如下圖所示依序切換。
平常請使用在「■■」的位置。

(□ 顯示燈亮 ■ 顯示燈閃爍 ■ 熄滅)

顯示	■	■	■■	■■	■■	■■	■■■	■■■	■■■	■■■	■■■
設定	更弱	弱	→	→	→	中	→	→	→	強	更強

解除 依照 1、2、3、4 順序操作

操作音「嗶嗶」響起，便回復到通常的調節 (3 階段)。

操作面板鎖定功能

讓操作無效，是為了防止誤觸操作面板，及兒童玩弄冰箱而設計的功能。

LO (按鍵鎖) 的顯示燈亮燈時，即使按了其他的操作部也無法切換。

1 按下操作面板的 **MENU** 按鍵，顯示燈亮

顯示燈全部燈亮後，顯示目前的所有設定。

2 持續按住 **Energy Saving** 3 秒以上，直到發出設定音為止

操作面板按鍵鎖可切換「開」或「關」。
購買時，設定成「關」(**LO** 熄滅)的狀態。

操作面板按鍵鎖的設定	「開」(鎖定中)	「關」(解除鎖定)
「LO」顯示	燈亮 LO	熄滅
設定音	嗶—	嗶嗶

通知事項

- 雖設定為操作面板鎖定，但電動門的功能也不會因而停止。
如果想要停止電動門的設定時，請先解除操作部的鎖定，持續按住 **Freezer** 3 秒以上直到發出嗶嗶聲音。 (→ 12, 13頁)
- 拔除電源插頭再插上插頭時，或停電後恢復供電時，有可能解除操作面板的鎖定。
- 為了省電，顯示燈約 40 秒即熄滅，但該設定直到解除為止仍持續進行。

箱門警報器

任何一個門開啟 1 分鐘以上時，會以聲音、燈光來告知冰箱門開啟。

所有的冰箱門都附有警報器功能。(但 R-WX670K 型號, R-WX620K 型號的上層冷凍室沒有箱門警報器功能。)

箱門的打開時間	1 分鐘後	2 分鐘後	過了 3 分鐘以後
警報音	嗶 - (3 次)	嗶 - (5 次)	嗶 - (連續) 大音量
顯示部分	閃爍	閃爍	閃爍
操作部	燈亮	燈亮	燈亮

通知事項

- 顯示部閃爍時縱使按下操作部也沒有反應。請將冰箱門關閉後再進行操作。
- 只有在「節電」模式設定時，冰箱門開啟時間達 30 秒後，門的警報器會發出聲響。但顯示部會在開啟時間 1 分鐘後閃爍。

各種功能

箱門警報器及操作音的音量調節

箱門警報器及操作音可設定為更大音量，也可以設定為靜音。

1 按下操作面板的 **MENU** 按鍵，顯示燈亮

2 持續按住 **Fridge** 3 秒以上，直到發出設定音為止

操作音的音量可切換成「標準」「大」「關閉」。設定的切換依照此順序輪替，請依個人需求切換設定音。(參照下表)
購買時，設定成標準音量。

音量	標準	大音量	關閉音量	標準
設定音	—	嗶—嗶—	嗶—	嗶嗶

(購買時) ↑

通知事項

- 箱門警報器或操作音，無法只調整任何一方的音量。
- 設定為不會發出聲響時，冰箱門警報器的文字顯示燈的閃爍也停止。
- 雖音量設定為「關閉」時，「製冰機清潔」的警報器、電動門「開」的操作音也會發出聲響。
- 當拔除電源插頭再插上插頭時，或停電後恢復供電時，冰箱門警報音則恢復到原來的標準狀態的設定。

三重抗菌除臭

利用三種除臭素材的完美組合，有效地捕捉並去除冰箱內含有硫磺系、氮系、醛系、酸系等四大異味分子。此外，並可抑制濾網所捕捉的細菌活動。

除臭濾網具有除菌效果。

●試驗機關：一般財團法人 BOKEN 品質評價機構 ●試驗方法：濾網密著法 (JIS Z 2801) ●處理零件名：濾網 ●除菌方法：將氧化觸媒塗抹在濾網 ●對象：濾網所捕捉的細菌 ●試驗結果：24 小時後達到 99% 的除菌效果。只是濾網單體的性能。此除菌效果並無法遍及冰箱內整體及所有食品。

省電

eco 運轉顯示燈

在運轉安定時 **ECO** 燈號會自動亮燈，來表示此時正進行省能源運轉。

減少冰箱門的開關次數，盡量縮短每次開啟的時間，請做為使用時的參考。

[eco 運轉顯示燈]

通知事項 **ECO** 無法燈亮時，可能是以下的原因。

- 剛設置完成後、或一次儲放大量的食品時
- 冰箱門開閉次數頻繁時 ([冰箱門開閉顯示燈] 亮燈)
- 當食品或包裝袋被箱門夾住，而箱門關不緊時
- 設定為「Quick」「Veg」時
- 冰箱周圍溫度達到 35°C 以上時



冰箱門開閉顯示燈

當冰箱門開閉次數多時，**Door** 則自動亮燈。

減少冰箱門的開關次數，盡量縮短每次開啟的時間，請做為使用時的參考。

[冰箱門開閉顯示燈]

- 通知事項**
- **Door** 亮燈後，約 5 分鐘後自動熄燈。
 - **Door** 亮燈時，**ECO** 則熄燈。

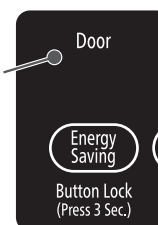

「節電」模式的設定

設定成節電模式時，將各冷藏室的冷卻調弱，可達到省電目的。

開啟冷藏室門達 30 秒以上時，冷藏室的 LED 庫內燈及真空冰溫室內的 LED 庫內燈的亮度會減弱，以節省電力。此外，長時間沒有開關冰箱門時，冰箱內部會緩慢冷卻，可以更加抑制電力消耗。

1 按下操作面板的 **MENU** 按鍵，顯示燈亮

顯示燈全部燈亮後，顯示目前的所有設定。

2 按下 **Energy Saving** 按鍵「Save」顯示燈亮

購買時，設定成節電模式「關」（熄滅）的狀態。

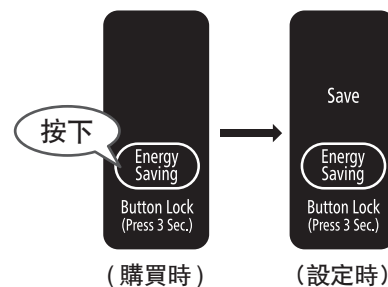

省電

解除

按下操作面板的 **MENU** 按鍵，顯示燈亮按下

Energy Saving 按鍵「Save」顯示燈熄滅

通知事項

- 將冷卻轉換為弱的時候，冰淇淋等會變軟、冷凍食品有可能會結霜。此外讓食品冷凍的凍結時間以及製冰時間也會增長。
- 當設定為「節電」時，「Save」的顯示持續亮燈。
- 當「Save」設定中，設定「Quick」時，則「Save」的設定會暫時解除。等「Quick」運轉結束後，會再次回復至「Save」的設定。
- 「Save」模式與「Veg」同時設定時，冷卻從「Veg」轉變到較弱的冷卻效果。→ 22頁
- 「冷凍室」「冷藏室」雙方，或任一方的溫度設定在「■」的時候，為了維持各存放室內的食品的新鮮度，冷卻效果不轉弱。

將防止結露的加熱器設定為弱（旋轉隔板部）

將防止結露的加熱器設定為弱時，可達到省電的目的。

當旋轉隔板部有結露時，請設定為標準模式。

旋轉隔板部的設定分為 1 至 2 階段，階段 2 最能達到省電目的。

加熱器設定為弱	標準	弱設定 階段 1	弱設定 階段 2	標準
設定音	—	嗶—	嗶— (2 次)	嗶嗶

(購買時)

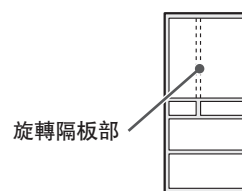

1 開啟下層冷凍室門

2 按下操作面板的 **MENU** 按鍵，顯示燈亮

顯示燈全部燈亮後，顯示目前的所有設定。

3 持續按住 **Powerful** 3 秒以上，直到發出設定音為止

防止結露加熱器設定為弱的階段將切換。

請重複上述的操作，設定所期望的階段（參照上表）。

4 關閉下層冷凍室門

通知事項

- 當拔除插頭再插入，或是停電恢復供電時，將會回復到標準設定。

保養方法



警告

● 清掃時，請一定要把電源插頭從插座拔掉。

■ 發現骯髒時

● 立即擦乾淨。看不到的部分也請一年清掃一次。

電源插頭

一年一~二次

將電源插頭從插座拔出，以乾布擦拭灰塵。



為了防止火災及觸電 → 4頁

箱門密封墊

一個月一次

請以軟布沾溫水擦拭。

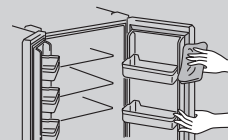

由於此部分容易髒，請擦乾淨。

箱門表面

一個月一次

箱門表面請以柔軟的布，沾溫水將污垢擦拭後，再用乾布擦拭乾淨。

玻璃表面殘留有膠布黏膠時，以塑膠橡皮擦擦拭之後，再以乾布擦拭乾淨。

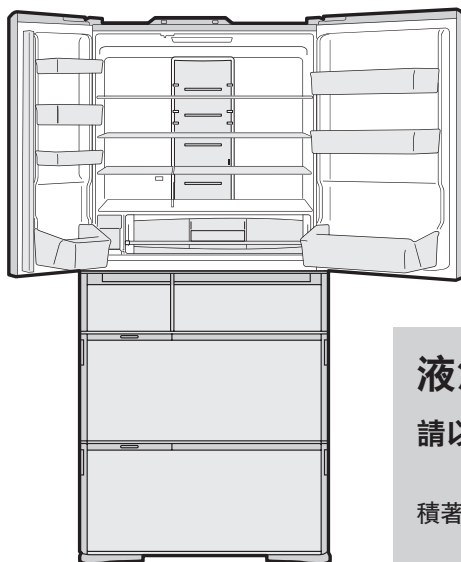

各層架・置物架

三個月一次

請以軟布沾溫水擦拭。



卸除方法請參閱 → 32頁

液汁承接處

一個月一次

請以軟布沾溫水擦拭。

積著液汁時，請擦乾淨。

液汁接收處

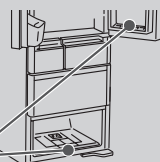

冰箱背面・地板

一年一~二次

拆除遮蔽架，將調節腳稍微抬起，把冰箱往身前方向拉，擦拭污垢。

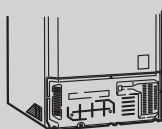

- 背面由於空氣對流的關係，容易堆積灰塵而弄髒。若是容易刮壞的地板，則鋪上保護用的板等。
- 在意冰箱的震動音，或因濕氣而導致背面牆壁變色或髒汙時，請將冰箱設置在距離牆壁(2cm以上)的地方。

置物盒

三個月一次

請以軟布沾溫水擦拭。

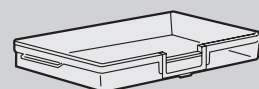

用水清洗蔬果保鮮室下層置物盒時，請倒轉讓水滴乾，並用乾布充分擦拭乾淨。此外請勿使用牙刷、洗碗刷等長刷毛的刷子清洗。可能會造成置物盒受損及蔬活保濕裝置破損。

卸除方法請參閱 → 33頁

※ 請勿用水清洗白金觸媒。

敬請依照指示操作

● 因為可能會造成箱門、塗裝面、塑膠、玻璃面受損、變色，請勿使用以下的東西。

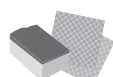

鹼性、弱鹼性的廚房洗潔劑(中性以外)、玻璃用洗潔劑、含氯漂白劑

刷子、研磨海綿、化學抹布

研磨粉、粉狀肥皂

去漬油、稀釋劑、酒精

熱水

請確認洗潔劑上「根據家庭用品品質表示法表示」的「液性」欄

- 沾到食用油、柑橘類的果汁、食品液汁時，請務必擦乾淨。因為其可能引發箱門、漆面與塑膠部件的損傷與變色。
- 因置物盒或抽屜的滑動軌道接觸面上塗抹了潤滑劑，保養時請勿擦拭。
- 磁鐵裝飾或是吸盤吸附在冰箱雪櫃的側面或冰箱門表面時，有可能會在表面留下痕跡。
- 拔除電源插頭時，會解除操作面板設定的功能，請再次確認設定。

真空冰溫室 一個月一次

1 拉出真空冰溫盒

卸除方法請參閱 → 32頁
請務必取出保存在真空冰溫盒內食品。

2 以下的零件，請以沾溫水的軟布擦拭

※ 請勿使用洗潔劑。

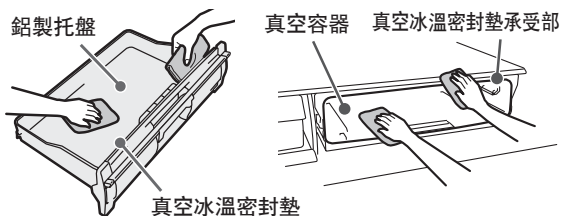

敬請依照指示操作

- 冰箱室內的頂部 (白金觸媒・LED 庫內燈的部分)，請輕輕擦拭。用力擦拭時可能造成破損。
- 真空冰溫密封墊如果使用溫水以外的洗潔劑，則有可能破損、變形、變色，無法保持真空狀態。

3 安裝真空冰溫盒

安裝方式請參閱 → 32頁

如果真空冰溫密封墊鬆了或是接觸不良，則無法維持真空狀態。

真空冰溫密封墊污垢時

1 從真空冰溫盒取下真空冰溫密封墊

以手握住右上方的真空冰溫密封墊的突起，小心地拆下密封墊。

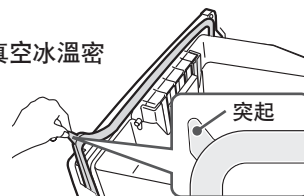

2 髒污的部分請以柔軟的海棉等清洗乾淨

※ 請勿使用洗潔劑。

3 以乾布將水擦拭乾淨後自然乾燥

4 擦拭真空冰溫密封墊安裝溝槽的污垢

真空冰溫密封墊安裝溝槽

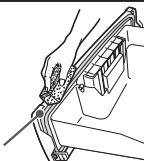

5 安裝真空冰溫密封墊

請將真空冰溫密封墊凸起與安裝溝槽的缺刻對準。

R-ZX740K 型號
R-WX740K 型號
請將密封墊的凹處對準盒的突起 (6 處) 後，確實地安裝。

R-WX670K 型號
R-WX620K 型號
請將密封墊的凹處對準盒的突起 (6 處) 之間後，確實地安裝。

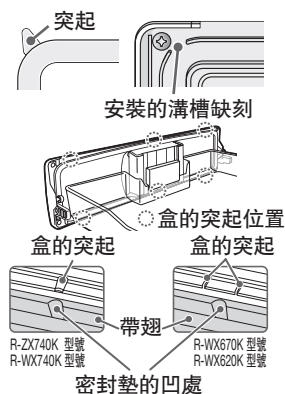

保養方法

電動抽屜

當有食品掉在電動抽屜中，或卡在抽屜上方，以及液體沉積時，請清洗電動抽屜。

1 電源插頭一定要從插座拔掉

2 卸除下層冷凍室以及蔬果保鮮室各箱盒 → 33頁

3 請取出掉下而被夾著的食品等

4 請用柔軟的乾布擦乾積水

注意事項

- 請勿用水洗電動抽屜組件，會導致故障。
- 請勿拆卸電動抽屜組件，會導致故障及受傷。
- 請注意切勿移動連結部。可能造成故障。



警告

- 保養前請務必拔下電源插頭，以免受傷。

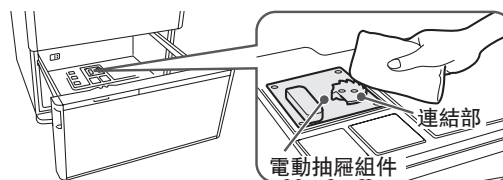

保養方法 (續前頁)

製冰機清潔

初次使用時

自動製冰機一星期以上沒有使用時



警告

- 請勿觸摸自動製冰機的機械部分。
(當製冰盤旋轉時，會有受傷的危險)

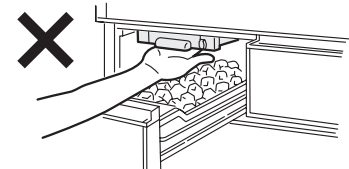

以水來沖洗製冰盤及給水管路。

準備

操作前請確認以下事項

都確認完了之後請操作下一個步驟。

給水槽

- 裝水至滿水線
- 超過儲水槽的安裝位置，正確的安裝。

製冰盒

- 有殘留冰塊時請清除

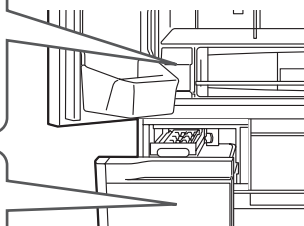

1

關閉所有的箱門

2

按下操作面板的 **MENU** 按鍵，顯示燈亮

顯示燈全部燈亮後，顯示目前的所有設定。

3

持續按住 **Ice Maker** 按鍵 5 秒以上，直到發出警示聲響為止

「Quick」、「On」、「Off」三個顯示閃爍，請在警示聲響了之後放開手指。

「製冰機清潔」便開始運作。(約 4 分鐘)

- 大約 4 分鐘之間，顯示閃爍、警報器會一直響。
- 操作「製冰機清潔」功能時在途中無法停止。
- 操作「製冰機清潔」功能當中，如果打開冰箱的任何一個門時，則有可能無法正常運作。請在製冰機清潔運作結束之前不要開啟冰箱門。
- 冰箱門警示聲設定在停止的狀態下警示聲也會發出聲響。 → 25頁



4

警示聲響及顯示燈閃爍停止後，塞住製冰盒內部的缺口部分，在製冰盒的底部鋪上乾淨的毛巾。

鋪上毛巾的主要目的是，清潔製冰盒時存在于內部的水會從製冰盒裡面的缺口部分流出，鋪上毛巾來吸收流出的水。

R-ZX740K 型號, R-WX740K 型號

R-WX670K 型號, R-WX620K 型號

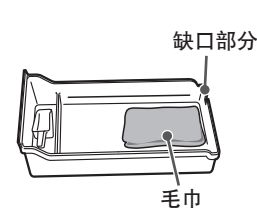
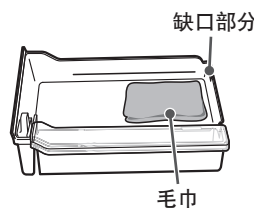

5

將製冰盒內的水擦拭乾淨後安裝在製冰室內

- 請取出擦拭水分後的毛巾。
- 給水槽裡剩下的水，可以繼續直接使用。
- 「製冰機清潔」結束後，自動設定回「On」。



給水槽

一星期一次

1

取出給水槽，卸除水槽蓋

請依照水槽蓋前方的箭頭指示方向拿起即可卸除。

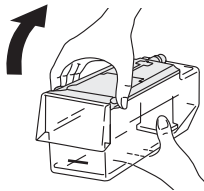

2

從水槽蓋取下密封墊圈及盒子

盒子由旋轉方式卸下來。



3

從盒子取下淨水濾片

以手指拉淨水濾網，從扣勾處卸下後再卸除箱盒。

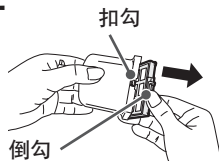

4

以水清洗給水槽各零件

以柔軟的海綿等用水洗乾淨。請不要使用洗潔劑等。

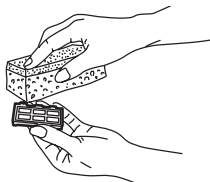

通知事項

●更換的基準約3~4年。→ 40頁

5

將給水槽的各部零件組裝，加入水之後再安裝

請從水槽蓋的後方插入，往箭頭方向關上。

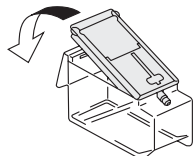

敬請依照指示操作

自動製冰機長期不使用時，請將給水槽洗淨後，充分乾燥後，再裝入原來的位置。
(特別是淨水濾片請務必充分乾燥)

製冰盤

一年一~二次

1

按下操作面板的 **MENU** 按鍵，顯示燈亮

顯示燈全部燈亮後，顯示目前的所有設定。

2

按下 **Ice Maker** 按鍵，「Off」顯示燈亮

停止往製冰盤給水。

※當「Off」閃爍時，約1分鐘待燈亮之後再進行以下操作。此外，外框無法拉出。

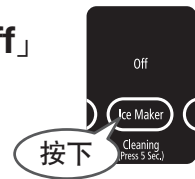

3

打開製冰室門，取出製冰盤

1 將扳手往橫的方向押。2 拉出框架。

3 護蓋(▲部)往身前方揭起

4 從框架裡取出製冰盤。

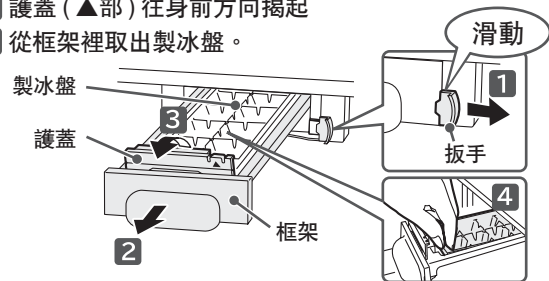

4

騰空製冰盤，用流水簡單沖洗。

請勿使用海綿·去污粉。
請勿刮傷表面。



5

打開製冰室門，安裝製冰盤

1 安裝製冰盤並關上。

2 關上護蓋，直到發出「卡噠」聲

3 將拉桿往右直到能滑動為止，把框架往內側推入。

4 請前後搖動框架，確認是否緊實地固定住。

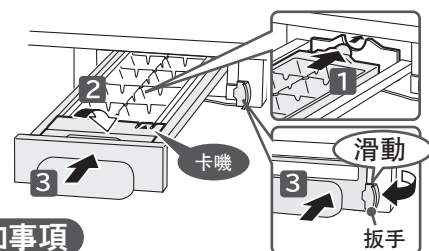

通知事項

●製冰盤的「框架推不到底」時，因為沒有設定「Off」，所以驅動製冰盤的馬達有可能已啟動。一旦卸除製冰盤，只將框架推入。關上製冰室門之後，再按下 **Ice Maker** 按鍵，設定為「Off」。約1分鐘後，製冰盤的驅動馬達的準備完成後，便可安裝。

6

按下操作面板的 **MENU** 按鍵，顯示燈亮，再按下 **Ice Maker** 按鍵，「On」顯示燈亮

開始自動製冰

保養方法

卸除組件的方法・安裝的方法

注意事項

- 卸除零件時，請先將放在零件上的食品移除。
- 請勿拆除此處未說明的零件。
想要卸除說明書上沒有說明的零件來清潔等時，請向技術中心諮詢。
- 請勿拆除真空冰溫室、蔬果保鮮室的白金觸媒。並且請勿以水沖洗。

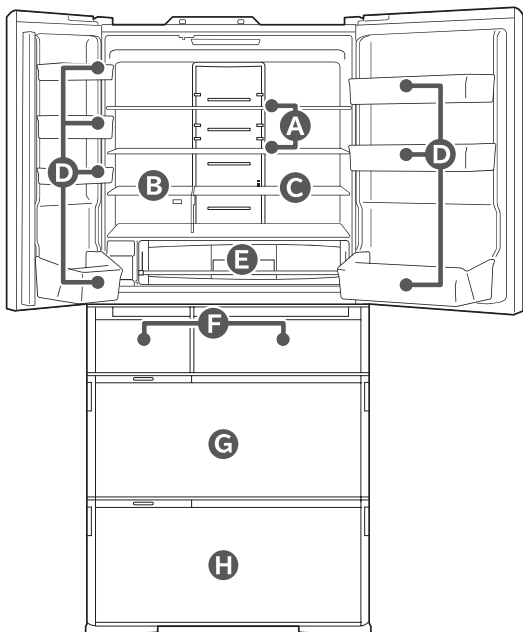

A 可調式層架上段・中段

敬請依照指示操作 拆除棚架上層之前，請先拆除棚架中層。

- 1 把層架內側稍微抬高，往前拉出。
- 2 如圖示將棚架直立。
- 3 讓其迴轉後拆除。

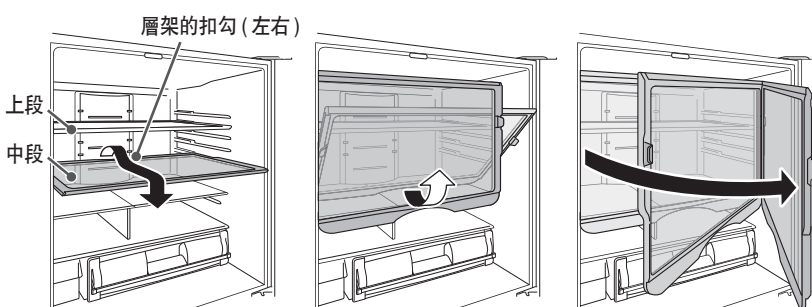

安裝時，把層架插放到最內側之後，把層架內側稍微抬高並推進去。
(將層架的卡榫掛在最內側的配件上)

通知事項 因玻璃層架較重，安裝，卸除時請特別小心。掉落時可能會被撞傷或是因破裂而被刮傷。

B 固定層架

往前拉出來，將右下 2 處的扣勾拆開並取下。

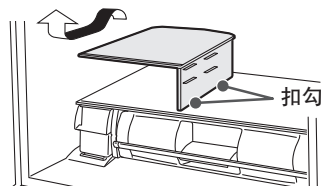

通知事項 層架的形狀因型號而異。

C 可調式層架下段

稍微抬高並取下。

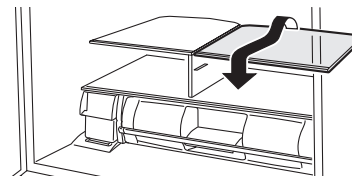

通知事項 層架的形狀因型號而異。

D 箱門置物架

一邊輕敲底部左右一邊提高便可卸取。
(牢固地固定)

注意事項 安裝時，請完全裝入到底。
如安裝不牢，會掉落，可能導致人員受傷。

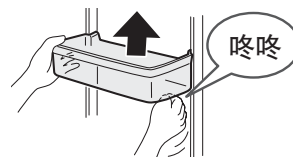

E 真空冰溫盒

卸除方法

拉出真空冰溫盒，往前方稍微向上抬起，上下搖動後拉出。

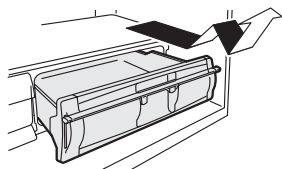

安裝方法

讓真空冰溫盒的左右突起
順著真空容器的導引軌道
滑動推入。最後再將把手
往下扳到底鎖住。

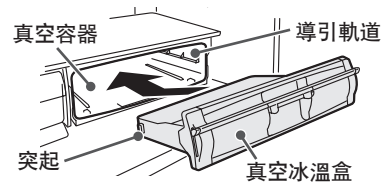

敬請依照指示操作 安裝後請數次拉出推進，確認是否正確安裝。

F 製冰盒 (製冰室) · 上層冷凍盒 (上層冷凍室)

打開門，向前方取出。

安裝時要將箱底面裝載在框架上。

- R-ZX740K 型號, R-WX740K 型號的製冰盒，請先將小物品收納空間的蓋子往前拉蓋住之後，再卸下製冰盒。

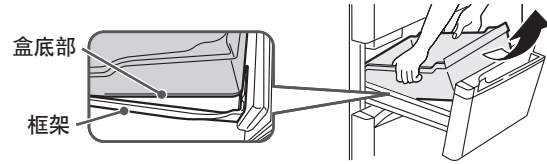

【只有 R-ZX740K 型號, R-WX740K 型號】

請依照以下的順序拆除小物品收納空間的蓋子。

(安裝時請依照反順序進行)

- 1 將蓋子滑動至一半的狀態，再將盒的側面扭曲，鬆開蓋子的扣勾。

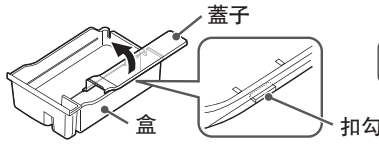

- 2 讓蓋子滑動，從後面拉出。

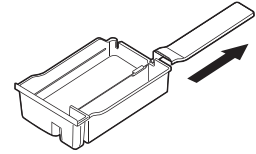

G 中層滑動盒 · 下層冷凍盒 (下層冷凍室)

- 1 打開門後，拉出中層滑動盒。

注意事項

- 請勿拆下上層滑動盒。

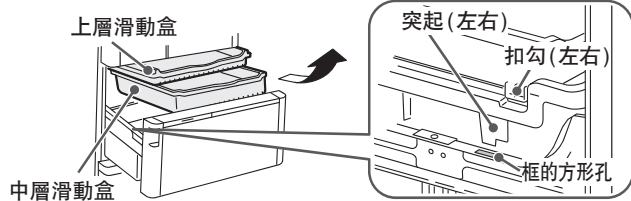

- 2 向上取出下層冷凍盒。

注意事項

- 不得拆下下層冷凍室與隔板。



注意事項

- 請勿撕開標貼。

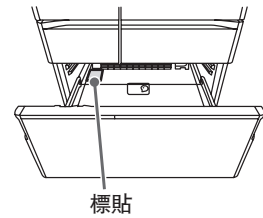

安裝冷凍盒時，請將下層冷凍盒左右突出的部分向門框兩旁的洞插入固定。
請將中層滑動盒兩旁的止動裝置插入下層冷凍盒的外側。

H 上層滑動盒 · 下層置物盒 (蔬果保鮮室)

- 1 將門往身前開啟，手持兩端往上抬起，再慢慢往拉出，放在地板上。

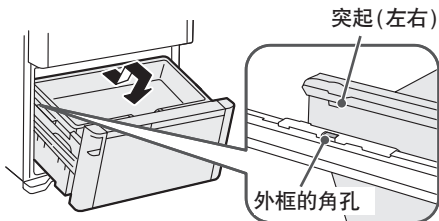

- 2 將上層滑動盒拉起。

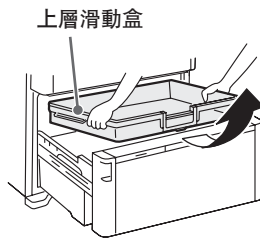

- 3 下層的置物盒朝身體方向向上抬起。

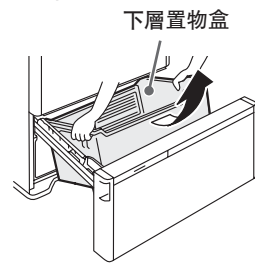

注意事項

- 開門時請注意腳切勿靠近門。腳有可能被門夾傷。
- 請注意，蓄積的水可能從下層置物盒背面流出。

若沒有正確的安裝時，會造成關閉時的異常聲音以及冰箱門無法關緊的原因。

敬請依照指示操作

- 無法卸下隔板。
- 若上層滑動盒沒有正確安裝時，可能導致滑動盒的零件破損。
安裝後，請將上層滑動盒前後滑動，以確認是否正確安裝。

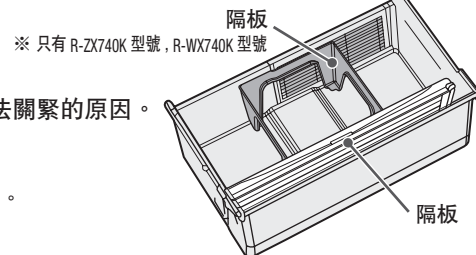

拉取式門的安裝方法 (製冰室 · 上層冷凍室 · 下層冷凍室 · 蔬果保鮮室)

製冰室 · 上層冷凍室

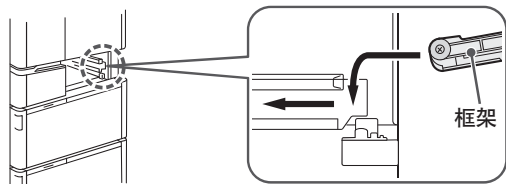

下層冷凍室 · 蔬果保鮮室

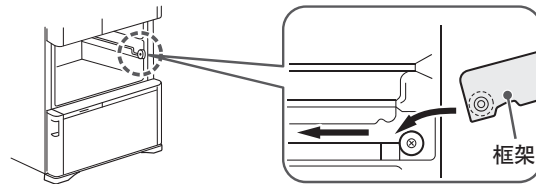

卸除組件的方法 · 安裝的方法

遇到問題時

在委託修理之前，請再次檢查以下幾點。狀況仍然不好的時候，請聯絡所購買的經銷店或敝公司技術中心。

	這種情況下	請確認	請依照這樣做。就是這樣的理由。
初次使用時	不冷	設置後是否未達 24 小時？	設置後至完全冷卻需要 24 小時。請將存放的食品間保留間隙，並儘量減少開閉次數，耐心等待。此外，夏天或食品大量存放時，至完全冷卻需更多時間。
	無法製冰	設置後是否未達 24 小時？	剛設置後，因冰箱未完全冷卻，到可以製冰需要 24 小時以上。請將存放的食品間保留間隙，並儘量減少開閉次數，耐心等待。
操作面板	玻璃觸碰部不起反應	是否顯示部  顯示亮燈？ 操作部設定為鎖定。	請解除操作面板鎖定設定。 (→ 24頁)
		冷藏室門開著嗎？	請關閉後再操作。
		操作部分是否附著水滴或是污垢？	以沾濕的布擦拭髒污後，再以乾布擦拭乾淨。
		戴著手套或貼著膠布嗎？	請直接用手指按。
		是否碰觸到周圍的操作部？	請只碰觸想要操作的操作部。
操作部熄燈		操作結束後，為節省電力，40 秒後顯示部熄燈。 (→ 11頁) 若要讓其亮燈時，請觸按 MENU 按鍵，或打開冷藏室門。	
操作部的設定隨意變更	其他使用者是否正在用智能手機操作？	一台雪櫃最多能用 5 台智能手機操作。	
自動製冰	完全不能製冰	是否顯示部的「Off (製冰停止)」顯示亮燈？ 設定為製冰停止。	請設定「On」或「Quick」。 (→ 18, 19頁)
		是否顯示部的「Water」顯示亮燈？ 給水槽內的水變少。	請加水至給水槽內。 (→ 18, 19頁)
		是否給水槽的水變少？	水量變少時，有可能無法製冰。 請試試加水加到給水槽的滿水線。 (→ 18頁)
		給水槽是否推入到超過「水槽安裝位置」線？	請將給水槽推至比水槽安裝位置更裡面。 (→ 18頁)
		是否有將拉桿往右直到滑動為止，框架推入到內側？	請將拉桿往右直到滑動為止，框架推入到內側 (→ 31頁)
		製冰盒裡面是否存放了冰以外的東西？	請從製冰盒中取出。
	很難結冰	儲冰量是否有局部超過最大儲冰界線？	請將冰塊整平。 (→ 19頁)
		是否頻繁地敞開門，是否一次存放了大量的食物呢？	冰箱內無法充分冷卻。 請試試在冰箱內冷卻前，盡量減少開閉門。請試試盡量空開儲存食品之間的間隙。
		是否冰箱周圍的溫度變低？	冬天，到可以製冰需要 4 小時以上。請儘量減少冰箱門開閉次數，耐心等待。
		是否剛從「Off (製冰停止)」設定改為「On」？	剛改變設定後，可能需要更多時間。請儘量減少冰箱門開閉次數，耐心等待。
食品或袋子是否被夾著，冷凍室或製冰室門是否關緊？		請去除被夾住的食物，確實關緊冰箱門。	
是否設定為「節電」模式？	請解除「節電」模式。 (→ 27頁)		
冰塊有凸起		是製冰盤的溝上積水凍結了。 不是異常。	
所儲存的冰塊變小 冰塊之間粘在一起	是否積存了舊的冰塊？	舊的冰塊會變小，且會互相黏結。如果只是用冰鏟就能將冰塊分離的話，表示沒有什麼問題。	
	是否頻繁地敞開門，是否一次存放了大量的食物呢？	請盡量迅速開閉箱門，以及減少開閉的次數。	
	冷藏室門或抽屜是否沒完全關緊？	關閉冰箱門時，請確實關緊。	
製成的冰塊很小	是否給水槽的水變少了？	當剩餘的水變少時，製冰機可能製成小的冰塊。 請試試加水加到給水槽的滿水線。 (→ 18頁)	
製成粘在一起的冰塊	是否有將拉桿往右直到滑動為止，框架推入到內側？	請將拉桿往右直到滑動為止，框架推入到內側 (→ 31頁)	
	製冰盤是否受損？	製冰盤一旦受損，可能造成冰塊將難以從製冰盤分離，破損的冰塊互相黏結的情形。 請與購買的專賣店洽詢。	
		製冰盤的溝槽部分殘留的冰塊會互相黏結。 不是異常。	
冰塊裡有白色混濁		是因為混在水中的氣泡被封在冰塊裡面了。	
	用礦泉水製冰了嗎？	水中含有的礦物質凍結會變白而混濁。即使在水裡融化了也會有白色混濁，不過無害。	
製冰盤的框架拉不出來	是否設定為「Off (製冰停止)」？	當自動製冰機正在製冰時拉不出來。請設定為「Off (製冰停止)」。當「Off (製冰停止)」顯示閃爍時，請等約 1 分鐘，等「Off (製冰停止)」顯示燈亮後再拉出。 (→ 31頁)	
無法製冰時		請設定成「Off (製冰停止)」。 請參考「製冰停止」。 (→ 19頁)	

這種情況下	請確認	請依照這樣做。就是這樣的理由。
不冷 不夠冷 冰淇淋變軟	食品或袋子是否被夾著，門關緊了嗎？	請去除被夾住的食物，確實關緊冰箱門。此外，食品收納時請注意食品的高度。
	是否塞入過多食品，是否一次放入了大量的食物呢？	食品之間請空開間隙存放。
	各存放室的盒子是否確實地安裝？	請正確安裝好。 (→ 33頁)
	根據冰箱的設置場所及空隙，環境狀況等，有可能會難以冷卻的情形。	請確認是否已正確安裝。 (→ 8頁)
	是否設定為「節電」模式？	請解除「節電」模式。 (→ 27頁)
	是否溫度設定在「■」？	不太容易降溫的室內，請變更溫度設定。
	在夏季等，電冰箱的環境溫度高嗎？	(→ 14, 21頁)
	是否長時間開啟冰箱門，或冰箱門開啟頻繁？	冰箱門敞開著時，冰箱內的溫度會逐漸上升。頻繁地開閉或是長時間敞開著門的話，冰箱內的溫度會難以下降。請減少冰箱門的開閉次數及盡量縮短開閉的時間。
	操作部的顯示是否依次改變？	因為設定為店面專用模式，請解除。 (→ 請參照下列)
結霜·結露 冰箱內及·抽屜框架上 結霜·結露·冰	冰箱門或抽屜是否沒完全關緊？	關閉抽屜或冰箱門時，請確實確認是否夾到食品或包裝袋，請確實關緊。
	是否長時間開啟冰箱門，或冰箱門開啟頻繁？	當冰箱門開閉時，可能因空氣中含的水分變成霜、冰，凝結在冷凍室的壁面或零件上。請盡量迅速開閉箱門，以及減少開閉的次數。此時請以乾布將霜、露水擦拭。
結霜·結露 冰箱的外側結露	冰箱周圍的溼度是否過高？	下雨天等室內濕度高的時候會結露。此時請以乾布將露水擦拭。
	是否防止結露的加熱器設定為弱的狀態？	冰箱周圍的溼度變高時，可能會有結露的情形。請將防止結露的加熱器設定為「標準」。請以乾布擦拭露水。 (→ 27頁)
	是否溫度設定在「■■■■」？	溫度設定為「■■■■」時，冰箱門表面可能有結露情形。請將溫度設定為「■■■」。請以乾布擦拭露水。
結霜·結露 冰箱背面及牆壁結露	是否冰箱周圍的溼度變高、冰箱背面和牆壁間的間隙變小？	請和冷藏庫背面距離 2cm 以上。 (→ 8頁)
結霜·結露 冷藏室中凝結露水	是否長時間開啟冰箱門，或冰箱門開啟頻繁？	冰箱門的開關次數頻繁時，或冰箱周圍溫度高時，壁面會起霧，在冷氣出風口附近會凝結露水。並不是故障。此時請以乾布擦拭。 
顯示部正在閃爍 冷凍·冷藏的溫度調節燈 號有三個以上正在閃爍。	冷凍「■■■■·■■·■」及冷藏「■■■■·■■·■」共六個燈號，請一一確認燈號的閃爍、熄燈。	請在右欄將閃爍的燈號做 <input checked="" type="checkbox"/> 記號，與顧客諮詢窗 <input type="checkbox"/> 聯繫。詳細紀錄才能正確的傳達。 
顯示部正在閃爍 Ice Maker 「On」顯示閃爍或 Freezer 「■■■■·■」及 Fridge 「■」顯示閃爍	在製冰室內除了自動製作的冰塊之外，是否放入其他的食物或冰塊？	有可能食品等碰到製冰盤。請先將製冰室內清空，再操作「製冰機清潔」。 (→ 30頁)
顯示部正在閃爍 -1°C 閃爍	是否在維修人員檢查後所發生的？	有可能是設定在維修人員確認運轉用的模式。約 15 分鐘後恢復通常模式。使用上沒有問題。
顯示部正在閃爍 Auto Door 閃爍	是否在維修人員檢查後所發生的？	有可能是設定在維修人員確認運轉用的模式。約 10 分鐘後恢復通常模式。使用上沒有問題。
顯示部正在閃爍 Quick On Off 全部呈閃爍	是否觸按 Ice Maker 按鍵長達 5 秒以上。	正在進行「製冰機清潔」。閃爍約 4 分鐘即停止。在顯示燈閃爍時，請勿開啟冰箱門。
顯示部正在閃爍 Ice Maker 「Off」閃爍	是否設定為「Off (製冰停止)」後所發生的？	自動製冰機正在運作中。閃爍約 1 分鐘即停止。在顯示燈閃爍時，無法取出製冰室的框架。
顯示部正在閃爍 全部的顯示閃爍	是否冰箱門開啟中？是否冰箱門夾住食品，或無確實關緊？	若冰箱門開啟狀態時，請關閉冰箱門。若冰箱門夾住食品，或無確實關緊，請除去被夾住的食物，將冰箱門確實關緊。
顯示部正在閃爍 以上各項以外的顯示燈閃爍	——	請與購買的經銷店商洽。
顯示部正在閃爍 操作部的顯示將依次改變。	——	因為設定為店面專用模式，請操作解除設定。店面專用模式時，無法冷卻運轉。打開冷藏室門 (左右)、冷凍室下層門。按下操作面板的 MENU 按鍵，讓其顯示亮燈。持續按下 Freeze 按鈕長達 10 秒以上，直到發出嗶嗶聲響數秒之內所有的顯示亮燈，店面專用模式解除，即開始冷卻運轉。關閉冷藏室門 (左右)、冷凍室下層門。

遇到問題時

遇到問題時 (續前頁)

這種情況下		請確認	請依照這樣做。就是這樣的理由。
大冷	太冷凍結了	溫度調節為「■■■」了嗎？	請設定為「■■■」。(→ 14, 21頁)
		環境溫度是否 5°C 以下呢？	周圍溫度低時可能冰箱內的溫度會太冷。請將溫度調節為「■」。
		是否放置在冷氣吹出口的前方？	請不要放置在冷氣吹出口前。加蓋或以保鮮膜包裹可以防止食品結凍。
聲音不對	冰箱發出的聲音嘈雜	地板是否有彎曲？	請鋪上厚度 1cm 以上的牢固板子後，將冰箱設置在板子上。(→ 8頁)
		冰箱是否靠著牆或家具？	請在冰箱的周圍空出間隙安裝。
		冰箱是否充分冷卻？	購買後，剛開始使用等冰箱還未冷卻時，箱門開閉頻繁時，周圍的溫度高時，由於壓縮機高速運作，可能會感覺到聲音大。
		是否設定為「Quick」？	設定在「Sensor Cool」「Quick」時，壓縮機及風扇馬達會加速運轉，聲音會變大。
	運作音長	————	因正處於省能源運轉狀態，壓縮機慢慢地運轉，所以可能運轉聲音會維持較久時間。
	有時聲音變大	————	因應冰箱內的溫度變化，而變更運轉的強度，所以有時會發出較大的聲音。
其他 例如聽到這樣的聲音時	其他 例如聽到這樣的聲音時	像流水的聲音 (啾啾啾) 像碰撞的聲音 (叩叩叩) 像沸騰的聲音 (噼噼噼) 像燒肉的聲音 (唧~)	是電冰箱的冷媒流動聲，融霜時的水流聲蒸發聲。不是異常。
		像摩擦的聲音 (啾啾) (“叩動”聲)	是冰箱的溫度變化時，或真空冰溫室的氣壓變化時，部件的摩擦聲。不是異常。
		像什麼被卡著的聲音 (嗒嗒嗒) 像呻吟的聲音 (嘆~) 像剛關門時的聲音 (呸~)	是控制冰箱內溫度的電氣部件或真空幫浦的運作聲。不是異常。
		自動製冰機的聲音 (啾~) (嘎啦嘎啦) (咯嗒咯嗒)	是冰塊從自動製冰機的製冰盤掉落時，或是製冰盤裡給水時所發出的聲音。不是異常。按下 Ice Maker 按鍵，讓其顯示為「Off (製冰停止)」時，就不會發出聲音。(→ 19頁)
		時常有的聲音 (卡嗒卡嗒)	為了冷卻冰箱內開始運作時的聲音。不是異常。
		箱門高低不平衡以及歪斜	左右箱門高低不平衡箱門歪斜
箱門高低不平衡以及歪斜	左右箱門高低不平衡箱門歪斜	是否由於地板材質太軟加上儲放物的重量使冰箱腳下沉？	冰箱雪櫃傾斜的時候，請鋪上 1cm 以上厚的堅固的板子。
		電冰箱的側面發熱箱腳底下吹出暖風	————
真空冰溫室的問題	打開時，不發出「咻-」的聲音	真空冰溫室的設定是否為「Off (關)」(非真空的冰溫)？	請將設定改為「-1°C」或「+1°C」(→ 17頁)
		把手往上翹著嗎？	請將把手往下押，鎖定。
		把手是否有推到最終的位置，牢牢地鎖住？	如果沒有鎖住，則無法啟動真空機能。請將把手往下推到底，確實地鎖緊。
		真空冰溫密封墊是否脫離？	請安裝真空冰溫密封墊。(→ 29頁)
		真空冰溫的密封墊與真空密封墊承受部之間是否夾著食品的包裝等、附著有污垢、線頭或垃圾？	若食品包裝等異物被夾住時，請除去異物。如果真空冷藏的密封墊髒了，請進行清潔。(→ 29頁)
		密封墊是否緊貼著呢？	若密封墊緊貼著，則無法維持密封狀態。若緊貼時，請將其剝離。因為左右面及下面無法看清楚，請將真空冰溫盒拆卸後進行確認。(→ 32頁) 若密封墊髒污時，請清潔乾淨。(→ 29頁) 破損、變形等時請更換密封墊。(→ 40頁)
是否在真空冰溫室或冷藏室門開啟關閉之後？	真空幫浦啟動後，至達到真空狀態約需 3 ~ 4 分鐘。關閉後，請等待 4 分鐘以上。		

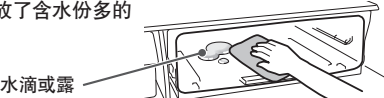
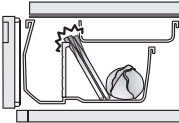
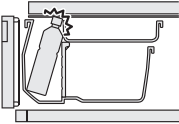
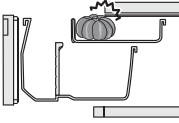
	這種情況下	請確認	請依照這樣做。就是這樣的理由。
真空冰溫室的問題	不知道是否在真空	打開真空冰溫時，是否發出聲音？	打開時如有「咻」的聲音，便是正常。
	把手不能上鎖	真空冰溫密封墊部分及真空冰溫盒的裡面是否有食品等被夾著呢？	若有被夾住請除去異物。
		是否正確地安裝真空冰溫盒？	請依照「安裝方法」所指示安裝真空冰溫盒。 → 32頁
	真空冰溫室的周圍發出「呸～」的聲音和振動	_____	是真空幫浦的運作聲音。 如夜間等介意有聲音的時候，可以停止真空幫浦的運作。 真空冰溫室請變更設定為「Off (關)」(非真空的冰溫) → 17頁
		是否真空冰溫盒夾住物品，或真空冰溫的墊圈髒汙？ 是否將把手往下推押到底，確實地鎖緊？	可能頻繁發出聲音及震動。 若食品包裝等異物被夾住時，請除去異物。 請清洗髒汙的真空冰溫密封墊。 → 29頁 請將把手往下推押到底，確實地鎖緊。
	真空冰溫室的內部或真空冰溫盒的周邊有水滴或結霜，冰	是否存放了含水份多的食物？ 	因為真空冰溫室是密封的狀態，如果存放水分較多的食品時，水分蒸發會在室內凝結成露水或結成霜。水分較多的食品建議以保鮮膜包覆。如果附著了水滴或結霜，請以乾布擦拭。
真空冰溫室的食品凍結	設定是否為「-1°C」或是「Off (關)」(非真空的冰溫)的狀態？	請設定為「+1°C」 → 17頁	
有異味	有塑膠味	_____	是因為在冰箱內使用了多數的塑膠部件，不過，充分冷卻後自然就會慢慢減輕。不是異常。
	冰塊有異味	給水槽，淨水濾片髒嗎？冰塊舊嗎？	為了防止「發黏」「水垢」，請定期清洗。 → 31頁
		_____	由於自來水中的氯元素凝縮，氯的氣味會很重。
冰箱內有異味	是否直接地儲放了氣味重的食品呢？	脫臭機能不能完全去除所有的氣味。 請用保鮮膜等密封後儲放。	
蔬果保鮮室	蔬果保鮮室中凝結露水	是否存放了大量的含水份多的蔬菜？	因為蔬果保鮮室比其他保存室的濕度高，會因蔬菜的存放量及種類，而可能出現在蔬果保鮮室的頂部、食品的表面產生結露的情形。 這並非異常現象。若在意結露的情形，建議將食品以保鮮膜包裹後再放入。此外，結露變多時，蔬果保鮮室的存放盒內可能有水滴蓄積。請以乾布將蓄積的水擦拭乾淨。
		是否蔬活保濕裝置被食品的外袋或容器所阻塞？	蔬活保濕裝置一旦被阻塞，很容易發生結露情形。 請將阻塞在蔬活保濕裝置的食品外袋或容器移至他處。 請以軟布將結露擦拭乾淨。
	蔬果保鮮室的門無法關閉，蔬果保鮮室的門開啟時上層滑動盒無法回復到鎖定的位置	上層滑動盒與下層置物盒之間是否夾有食品等異物？ 	請除去被夾住的異物。
是否有寶特瓶或食品碰觸到上層滑動盒的把手部位？ 		存放時請勿讓寶特瓶或食品碰觸到把手部位。	
是否有食物被夾在上段置物盒及潤澤護蓋之間？ 		請除去被夾住的物品。 此外，請勿在食品接觸到潤澤護蓋的狀態下，硬將冰箱門關上。	

遇到問題時

遇到問題時 (續前頁)

這種情況下	請確認	請依照這樣做。就是這樣的理由。	
電動冷藏室門	聲響很大 有些不正常的聲響	碰撞的聲音 (嘖嘖・嘖嘖)	這是電動冷藏室門的操作聲響。不是異常。
		低沉的聲音 (吭吭)	這是電動冷藏室門的操作聲響。不是異常。
		比起下層冷凍室・蔬果保鮮室可以聽到較大的運轉聲。	比起下層冷凍室・蔬果保鮮室可以聽到較大的運轉聲。此外・因收納食品的量不同・會有不同的聲音。不是異常。
	雖碰觸電動冷藏室門的操作部・也打不開	Auto Door 顯示燈是否熄滅了?	請讓 Auto Door 顯示燈亮。 (→ 12頁)
		製冰室或上層冷凍室的任何一個是否開啟狀態?	請關閉開啟的抽屜門後・再碰觸電動冷藏門的操作部。
	電動冷藏室門不能關閉	是否有食品或食品袋卡在抽屜內?	請除去被夾住的食物等異物。
電動操作時是否停電或者箱門受到了撞擊?		因為電動冷藏室門的功能在中途停止・請以手動方式關上冷藏室門。	
電動冷藏室門的開啟程度較小	收納的飲料或食品是否觸及冷藏室內壁?	請除取觸及內壁的飲料或食品。	
	是否放置的位置呈水平狀態?	隨著冰箱的設置條件・電動冷藏室門開啟的角度可能有所改變・或在開啟之後會稍微關閉的情形・這並非故障。	
縱使操作面板鎖定時 電動冷藏室門仍可以動作	—————	即使操作面板鎖定時電動冷藏室門的功能也不會停止。若想讓電動冷藏室門功能停止時・首先解除操作面板的鎖定・再按下 Freeze 按鍵持續 3 秒直到發出嗶嗶聲響為止。 (→ 12, 24頁)	
電動抽屜	聲響很大 有些不正常的聲響	碰撞的聲音 (嘖嘖・嘖嘖)	這是電動抽屜的操作聲響。不是異常。
		呻吟的聲音 (嘆~)	這是電動抽屜的操作聲響。不是異常。
		蔬果保鮮室比冷凍室下層的運轉聲音大。	“蔬果保鮮室”的操作聲響比“下層冷凍室”的大。此外・會因收納食品的量不同而有所差異。不是異常。
	即使按下電動抽屜開關・箱門也不開啟	Auto Door 顯示燈是否熄滅了?	請讓 Auto Door 顯示燈亮。 (→ 12頁)
		“下層冷凍室”或“蔬果保鮮室”是否開著?	關上開著的電動抽屜・再按下你要打開的電動抽屜開關。
	電動抽屜不能開啟 / 關閉	是否有食品或食品袋・保鮮膜等被夾住?	請除去被夾住的食物等異物。
		電動操作時是否停電或者箱門受到了撞擊?	箱門不能開關自如・因為沒有正常完成電動抽屜功能操作。用力地將箱門推入。或者請在拉開門的狀態下拔掉電源插頭・等 10 秒左右後再插上。
上層置物盒與潤澤護蓋之間夾著食品等異物?	 請將被夾住的物品去除。此外・潤澤護蓋內有食物時請勿強硬將門關閉。		
電動抽屜開啟得不夠大	—————	開始動作時・推出抽屜的尺寸大約在 15cm 以上。隨著冰箱的設置條件・有可能拉出抽屜的尺寸稍微不同・或是門以電動的方式開啟後又稍微退回的現象。不是異常。	
縱使操作面板鎖定時 電動抽屜仍可以動作	—————	即使操作面板鎖定時電動門的功能也不會停止。若想讓電動門功能停止時・首先解除操作面板的鎖定・再按下 Freeze 按鍵持續 3 秒直到發出嗶嗶聲響為止。 (→ 12, 24頁)	

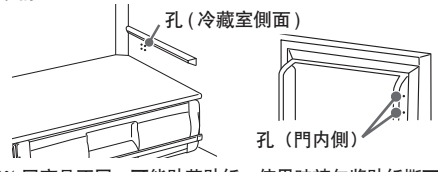
這種情況下	請確認	請依照這樣做。就是這樣的理由。
觸碰到機體會感覺到微量的電流	——	電冰箱會帶有靜電，安全上沒有問題。
電視機・收音機等發生有雜音・映像的花亂	——	是從電冰箱發出的微弱電磁波的影響。 要安裝時請遠離電視機、收音機、門鈴對講機等。 建議在離開天線等的地方接電源。
塑膠零件上有像傷痕一樣的細線	——	是塑膠成型時發生的樹脂流痕。透明的部件會特別顯眼，強度上沒有問題，不會破裂。
箱門面或側面・頂面上有波紋或歪扭	——	冰箱的製造工程上，會發生輕微的波紋或歪扭。 根據照射方向及亮度等會感到顯眼，這不是異常現象，在性能上也沒有問題。
箱門內側有小的洞	——	這個洞是在冰箱製造過程中，填充斷熱材料時為了讓內部的空氣往外散所挖的洞。不是損傷也不是異常情形。  ※ 因商品不同，可能貼著貼紙，使用時請勿將貼紙撕下。
停電了	——	在到恢復之間，請減少箱門的開閉，避免重新再存放食品。停電後恢復供電時，請確認操作部位的設定。
長時間不使用冰箱	——	請將冰箱內的東西全部清出。 請先將電源插頭拔除，再進行冰箱內、自動製冰機的清潔。→ 28~31頁 所有的門打開讓其乾燥 2 ~ 3 天。
除霜	——	此電冰箱自動除霜，不需要操作。溶解了的水會積在蒸發盤上，自動蒸發。
移動・搬運	——	請參閱「移動・搬運的事前準備(搬家時)」→ 40頁
玻璃破裂 (冰箱門玻璃) (玻璃層架)	——	請勿觸碰破碎的玻璃，立刻聯絡購買的銷售店，委託修理。
關閉冰箱門時，其他門則自動開啟	——	是否關閉冰箱門時用力過猛呢？ 因為各冷藏室的冷氣通路是相連通，有可能因為關閉冰箱門時的風壓，而導致其他門瞬間開啟。
冰箱門關閉後，再想要打開時，感覺很重	——	冰箱門是否長時間處在開啟狀態呢？ 在冰箱內的空氣瞬間被冷卻，此時短時間內壓力變低所造成的現象。 請勿長時間開啟冰箱門，縮短關閉的時間。
特別在意震動音，因濕氣而導致背面牆壁變色・髒污時。	——	請將冰箱設置在離背面牆壁 2cm 以上。→ 8頁
小蒼蠅等昆蟲飛入冰箱時	周圍是否有蒼蠅？	敬請保持周邊環境乾淨。 請放置蒼蠅忌避物品或補蠅器。
	冰箱內是否存放氣味強烈的食品？	為了避免氣味吸引蒼蠅，請將食品加蓋或以保鮮膜包覆。
	箱門是否長時間開啟？	請盡量在拿取食品後馬上關上箱門。

其他



遇到問題時

移動・搬運的事前準備 (搬家時)

- | | | | |
|----------|---|----------|---|
| 1 | 將食物及冰塊取出 | 7 | 在地板上鋪上鋪墊或布，將冰箱往後傾倒，讓內部的水流出
<small>舊的布巾等</small> |
| 2 | 將給水槽、製冰盤的水倒掉 | 8 | 搬運時請握住搬運把手搬運，並請 2 人以上進行搬運
<small>運輸時請勿將冰箱橫放。(冰箱故障的原因)</small> |
| 3 | 拔除電源插頭
<small>要搬動之前拔除即可</small> | 9 | 在預定放置的位置，請依照「使用前的準備」的指示進行設置。
<small>→ 8, 9頁</small> |
| 4 | 拆除冰箱遮蔽架，將調整腳升高
<small>→ 8頁</small> | | |
| 5 | 以膠布將冰箱門・電源線固定 | | |
| 6 | 移動・搬運時請鋪上保護用的鋪墊或布
<small>防止刮傷地板、或冰箱內部殘留水流至地板。</small> | | |

另購零件

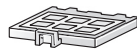
■以下零件更換時，請務必向經銷店指明冰箱的型號，購買專用的零件。

這種情況時	商品名	型號	商品型號	
冰塊有味道時 ●可能淨水濾片老舊、髒污。 (約 3 ~ 4 年更換一次)	自動製冰用淨水濾片	全機種通用	RJK-30	
無法維持真空狀態 ●可能破損・變形・變色	真空冰溫密封墊	R-ZX740K 型號 R-WX740K 型號	R-WX7400G 311	
		R-WX670K 型號	R-XG6700G 311	
		R-WX620K 型號	R-XG6200G 311	

CONTENTS

BEFORE USE

SAFETY SUGGESTIONS	42
BEFORE USE	46
Preparation before use	46
LEARN NAME & FUNCTION OF EACH PART ...	48
Name of each compartment, temperature guide, and examples of stored food	48
Functions of the Control Panel	49

GENERAL USE

Auto Door	50
Setting the Auto Door	50
Using the Auto Refrigerator Door	51
Using the Auto Drawer	51
REFRIGERATOR COMPARTMENT	52
Adjusting temperature in a refrigerator compartment ...	52
Adjust the height of a pocket/shelf	52
When keeping food at lower temperatures (using "Sensor Cooling" function)	53
When you want to quickly cool the foods. (using the "Spot Powerful Cooling" function)	53
VACUUM COMPARTMENT	54
Key points for using appropriate temperatures	54
Change the settings of the Vacuum Compartment ...	55
When opening/closing the door of the Vacuum Case ...	55
ICE COMPARTMENT (AUTOMATIC ICE MAKER) ...	56
How to make Ice	56
Stored ice amount and ice-making time	57
Quick Ice Making	57
Stop Ice Making	57
Water Supply indicator	57
When the "On" indicator blinks, or the "■ ■ ■" and "■" Freezer indicators and the "■" Fridge indicator blink	57
FREEZER COMPARTMENT	58
Stored foods	58
When storing food	58
Adjusting temperature in a refrigerator compartment ...	59
Using the Delicious Freezing	59
VEGETABLE COMPARTMENT	60
Stored foods	60
Adjusting temperature of Vegetable Compartment [Vegetable Compartment (MAX)]	60
When storing food	61
Tips for storing vegetables	61
VARIOUS FUNCTIONS	62
Fine adjustment of the temperature (Refrigerator Compartment / Freezer Compartment)	62
Locking the Control Panel	62
Door Alarm	63
Door Alarm and volume adjustment of the operation sound ...	63
Triple Power Deodorizing Effect	63

Energy Saving	64
"eco" Operation indicator lamp	64
Door Open & Close indicator lamp	64
Setting "Energy Saving" mode	65
Set the condensation prevention heater to MIN. (Swing partition) ...	65

MAINTENANCE

MAINTENANCE	66
Power plug / Door gaskets	66
Surface of door / Each shelf/pocket / Case	66
The back/floor of the refrigerator / Liquid receivers ...	66
Vacuum Compartment	67
Auto Drawer	67
Ice Maker Cleaning	68
Water supply container	69
Ice tray	69
HOW TO REMOVE/ATTACH PARTS	70
Height adjustable upper and middle shelf	70
Fixed shelf	70
Height adjustable lower shelf	70
Door pocket	70
Vacuum Case	70
Ice Case (Ice Compartment) • Upper Freezer case (Upper Freezer) ...	71
Slide case and lower freezer case (Lower Freezer)	71
Upper Case, Lower Case (Vegetable Compartment)	71
How to attach the slide door (Ice Compartment/Upper Freezer/ Lower Freezer/Vegetable Compartment)	71

TROUBLESHOOTING

TROUBLESHOOTING	72
Initial stage	72
Control Panel	72
Automatic ice making	72
Refrigerator does not cool	73
Frost and/or dew occurs	73
Lamp at Display Section is blinking	73
Refrigerator cools overly	74
Abnormal operating sound is generated	74
Door is not in a horizontal state	74
Refrigerator becomes hot	74
There is something strange with the Vacuum Compartment ...	74
It smells strange	75
Vegetable Compartment	75
Auto Refrigerator Door	76
Auto Drawer	76
Others	77
Transporting your refrigerator (transport for moving)	78
AVAILABLE PARTS	78
ABOUT NON-CFC REFRIGERATORS/STORABLE WEIGHT	79

BEFORE USE

GENERAL USE

MAINTENANCE

TROUBLESHOOTING

SAFETY SUGGESTIONS

Ensure to follow these precautions

When using this appliance, failure to follow safety precautions may result in personal harm, harm to other people, and also damage to property.

■ The following pictographs categorize and explain the level of possible harm or damage that may occur from ignoring suggestions resulting in missing the appliances.



WARNING

Suggestions headed by this pictograph indicate "There is high chance of serious injury or death" if ignored.



CAUTION

Suggestions headed by this pictograph indicate "There is a high chance of injury or damage to property" if ignored.

■ How the suggestions should be taken are indicated and categorized by the following symbols accompanied by explanations. (The symbols below are examples)



This symbol indicates something you must not do. (Prohibited)



This symbol indicates something you must do. (Compulsory)

■ This refrigerator uses flammable refrigerants. The symbol column below states the precautions on flammable refrigerants.



This symbol denotes the precautions on flammable refrigerants.

WARNING

Installation



● Take measures to prevent overturning of refrigerator due to earthquake, etc.

- Overturning of the refrigerator could result in personal injury.

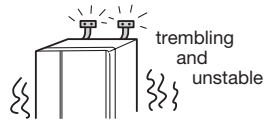

Wetting Prohibited

● Do not install the refrigerator in damp places or where water may splash.

- This may impair electricity insulation causing electric shock or fire.



Handling the power and power cable



Prohibited

● Avoid usage that may cause the wall outlet or power cord components to work beyond their specified electric current.

Also do not use power sources that are not a rated AC voltage.

- If a power source is shared with other appliances, double or multipoint adapters may heat up beyond normal levels and cause fire.
- Use a wall outlet rated above 10 ampere by itself.

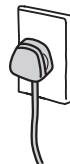

● When positioning the appliance, ensure the supply cord is not trapped or damaged.

(The power cord or plug should not be cut, modified, touched with hot implements, bent by force, twisted, pulled, have heavy objects placed on it, squeezed by the refrigerator, or be bound or tied up.)

Using a damaged power cord may cause electric shock, short circuits, or fire.

- If the supply cord is damaged, it must be replaced by the manufacturer or its service agent or a similarly qualified person in order to avoid a hazard.

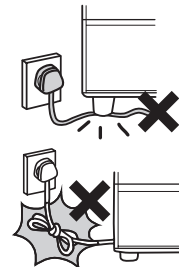

● Connect the power plug firmly to a power outlet with the cord running down.

- Connection of the power plug with the cord running up could apply stress on the cord and cause electrical short or overheat, which could result in electrical shock or fire.
- Incomplete connection of the power plug could result in electrical shock or fire due to heat.

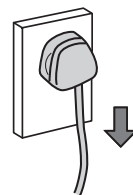

● Clean the dust on the power plug frequently.

Insulation failure from moisture when dust collects on the power plug may cause fire.

- Unplug the power plug and wipe it with a dry cloth.



WARNING

Handling the power and power cable



Wet Hands Prohibited

- **Do not insert or remove the power plug with wet hands.**
 - This may result in electric shock.
- **This appliance is not intended for use by persons (including children) with reduced physical, sensory or mental capabilities, or lack of experience and knowledge, unless they have been given supervision or instruction concerning use of the appliance by a person responsible for their safety. Children should be supervised to ensure that they do not play with the appliance.**



- **Be sure to unplug the power plug before maintaining the refrigerator.**

Continued use may cause electric shock or injury. → Pg.66

- Always hold the plug when unplugging it.

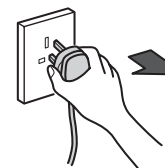

During use



Wetting Prohibited

- **Do not splash water on or inside the refrigerator.**

- This may impair electrical insulation causing electric shock or fire.



- **Do not put water containers on the refrigerator.**

- Spilled water may impair insulation of electrical components causing faulty electrical currents. This may result in electric shock or fire.



Prohibited

- **Do not put in things that may catch fire.**

- Benzine, ether, LP gas, thinner, adhesives may ignite an explosion.

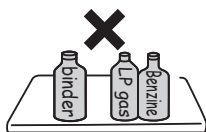

- **Do not store dry ices in the refrigerator.**

- It may be dangerous of busting if placed in a bag or etc.

- **Do not use flammable sprays near the refrigerator.**

- Sparks from points of electrical contact such as door switches may ignite a fire.



- **Do not hang on the doors or step on the various compartments.**

- Injury may be caused by the refrigerator tipping over or hands getting caught between doors.



- **Do not put too much force on the door by opening it too much or leaning on the opened door.**

- **Drugs, chemicals, research and experimental substances should not be stored in the refrigerator.**

- Substances that require precise conditions for storage cannot be stored in a domestic refrigerator.



- **Do not put things on top of the refrigerator.**

- Opening and closing doors etc. may cause things placed on top of the refrigerator to fall resulting in injury.



- **Do not remove the cover of the interior lamp.**

- When the interior lamp is damaged, please contact the service centre for replacing the lamp to avoid injury.

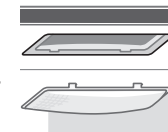

- **Do not add impact to the glass door.**

- **Do not locate multiple portable socket-outlets or portable power supplies at the rear of the appliance.**



Contact Prohibited

- **Do not touch the machinery components of the automatic ice maker.**

- There is a danger of injury when the ice trays are rotating.



- **Children should be supervised to ensure that they do not play with the appliance.**

- **When an infant child may use the Auto Door or Auto Refrigerator Door to make mischief, please stop the Auto Door function.** → Pg.50

⚠ WARNING

Concerning the refrigerant (Be careful of the following related to the use of flammable gas.)



Prohibited

- **Do not scratch or damage the main body of the refrigerator with a sharp object such as screw.**
Since the refrigerant used is flammable, any leakage from the pipe inside the wall may cause ignition and explosion.

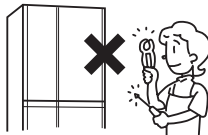

- **Do not use mechanical devices or other means to accelerate the defrosting process, other than those recommended by the manufacturer.**
- **Do not use electrical appliances inside the refrigerator.**
 - If the refrigerant leaks, sparks on the contact may cause ignition and explosion.



- **Do not damage the refrigerant circuit. If you happen to damage the refrigerant pipe, stay away from the refrigerator and avoid using fire and electrical appliances.**
Should you damage the refrigerator, open the window to ventilate and contact the authorised service centre.

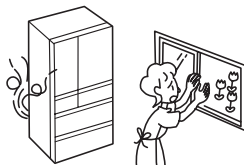

- **Allow clearance around the refrigerator and keep ventilation openings when installing it.** → Pg.46
Leakage of the refrigerant may accumulate and cause ignition and explosion.

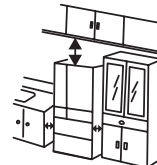

- **Please consult your dealer or the Recycle Hotline of the Recycle Centers in the Environmental Protection Administration when discarding the unit.**
If the refrigerant leaks, it may cause ignition and explosion.



- **The warning label and name plate including this symbol affixed on compressor and refrigerator should be kept throughout the life of the refrigerator.**

- **Handling, service and installation of used flammable refrigerant shall be done by Hitachi authorized service companies or service engineer only.**

In case of emergency



- **Stop the refrigerator by unplugging it if it is not running properly or breaks down.**
Continuous running may cause electric shock or injury.
 - Always hold the plug when unplugging it.

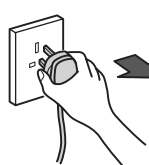

Disassembly prohibited

- **Do not disassemble, repair, or modify your refrigerator.**
Injury may be caused by ignition of fire or faulty running.
 - Please consult with a retailer if any repairs or disassembly are required.



- **In the event of gas leak, do not touch the refrigerator and open windows to allow ventilation.**
 - Sparks from points of electrical contact such as door switches may ignite explosions causing fire or burn injuries.



When discarding the unit



- **Before discarding the unit or recycling, remove the door gaskets to avoid the risk of an infant or child being entrapped inside.**

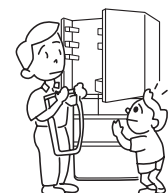

CAUTION

When moving the refrigerator



Prohibited

- **Do not move the refrigerator by using its wheels as it may damage the floor.**

- Please lay a protective mat.

- **Never hang the handle with a crane, etc.**
- **Take care not to bang the back / side of the refrigerator.**

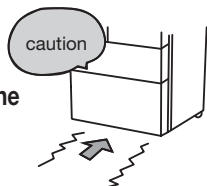

- **Use the carrying handle when carrying it.**

Your hands may slip resulting in injury if you hold the refrigerator at other places than the carrying handles.

- More than 2 persons should carry the refrigerator for safety reasons.
- Carry it with the door facing upward; as shown in the illustration.
- Use a tape to fix an electric plug/power cord so that it may not hang down.



During use



Prohibited

- **Do not put bottles in the Door Baskets if they do not sit properly on the bottom of the front section.**

- Forcing in items like large bottles may result in them getting tipped over, causing injury.



- **Do not put the glass bottles in the Freezer Compartment.**

- Bottles may break from the contents freezing and cause injury.

- **When opening or closing a door while the adjacent door is left open, exercise caution lest your hand or a finger should be caught between the opened doors.**

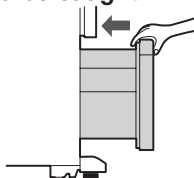

- **Do not close a door while holding a portion other than the handle.**

- **Do not put your feet too close when opening the bottom door of the refrigerator.**

- When opening this door you may hit the instep or other parts of your feet resulting in injury.



- **Do not put your hands or feet under the base surface of the refrigerator.**

When cleaning, putting your hands under the base surface of the refrigerator may result in injury by cutting them on sheet metal parts.

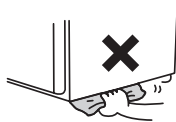

- **Do not give a hard impact to the glass shelf. (The glass shelf may be broken, causing personal injury).**

- **Do not have food items protruding over the front of the shelves.**

- Injury may be caused from items like bottles getting knocked over.

- **Do not open or close the door with force. (Doing so may cause food to drop)**

- **Do not open or close a door while other person is using the refrigerator.**



- **Do not open or close a door of the Refrigerator Compartment while holding the handle of the drawer.**

- **Do not touch the food and containers inside the Freezer Compartment with wet hands.**

- This may cause frost injury. (Especially in the case of metal items)

- **Do not eat food that smells strange or has changed color.**

- Spoiled food may cause serious sickness.

- **Do not press the auto door switch on the auto door compartment with knee, etc.**



- **Avoid placing anything like a bottle near the auto door compartment.**

- **Neither heat the glass surface of the glass shelf nor put a hot item on it.**

- **Be careful not to operate the Auto Door when another person is in front of the refrigerator, which may lead to personal injury unexpectedly caused by the opening door.**



- **To prevent water from dripping on the floor.** Water due to dew and/or frost may drip on the floor if there is a gap clearance around the door for a long time. Close the door completely without no gap.

- **When opening and closing a door while other door is opened, be careful lest your finger or hand should be caught between the opened doors.**

- **Take care when removing the glass shelf because it is heavy.**

- **When you hear an abnormal sound or find abrasion powder during the opening or closing of a door, stop using the refrigerator and ask us for inspection.**

BEFORE USE

Preparation before use

1

Please arrange it as shown below

- The floor should be sturdy and flat.
Lay a board with 1cm thickness on the floor if the refrigerator is installed on the carpet, tatami mat, flooring or PVC sheet flooring which may be hollow or discolor.
- Place the refrigerator away from direct sunlight and heat.
This will reduce adverse effects to refrigerating power and keep electricity cost down.
- Do not place it in damp areas, and ensure good air ventilation.
This will prevent the refrigerator from rusting and dew condensation.
- The place should be separated from other equipment.
To prevent disturbance (noise / scattered image) to TV and others attributable to the refrigerator.
- Provide a heat-releasing space (See the right diagram)
- ※ The actual size of the center part of the side of the refrigerator's main body is slightly larger than the nominal size. Therefore, please allow enough space around when installing the refrigerator.
- ※ If you care about discoloration of or dirt on the rear wall, provide a gap of **2 cm or more**. This also prevents vibration noise or dew condensation on the rear wall due to high humidity.

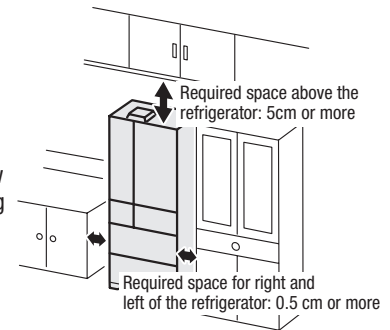

2

Fixing the refrigerator on the level or adjusting its horizontal level

- 1** To remove leg covers, hold the both ends of one leg cover and pull it towards to you and repeat this operation for another leg cover.

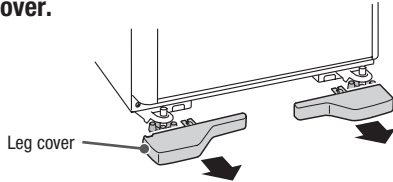

- 2** Place pads under the adjustable mounts.
Place pads under the adjustable mounts evenly so that they can be leveled.

- Always wipe the adjustable mounts and floor clean before placing pads. Adherents may scratch the floor if they remain.

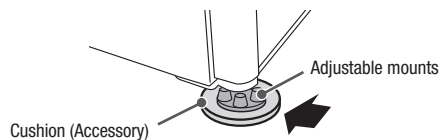

- 3** Rotate the right and left adjustable mounts until they reach the floor.
Adjust the mounts so that the right and left doors of the Refrigerator Compartment get parallel.

The height of the door can be adjusted 1mm every one turn of the adjustable mount. Clamp the supplied tool adjusting to the shape of the adjustable mounts.

- The left side door is lower.
- The right side door is lower.

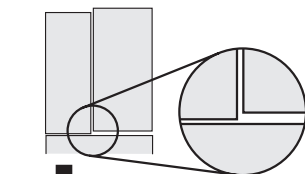

Turn the left Adjustable mount to lower the left side door.

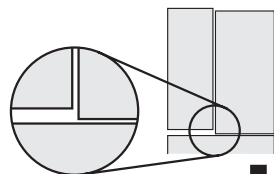
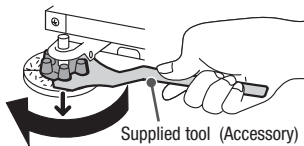

Turn the right Adjustable mount to lower the right side door.

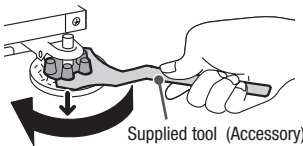

- Be careful not to scratch the floor with the supplied tool when turning the adjustable mount.
- Excessively turning an adjustable mount may cause it to detach.

Make sure to use a supplied tool and 2 cushions

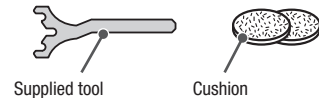

Notice

- Depending on the material or strength of a floor on which the refrigerator is installed or the weight of food put in it, a door may sag in several days (about five days) after the installation.
If this happens, adjust the parallelism between the doors again.
- Installing the refrigerator on an unlevel floor or sinking of its leg(s) due to a floor which is not strong enough to support the weight of food may cause a difference in level between the right and left doors.
This does not affect the refrigerator function. Adjust the parallelism of the doors according to the left procedure if you want to correct it.
- Correcting any left/right lean and lifting slightly the front side of the refrigerator until the door can close easily and completely.
- When you release your hand from a refrigerator door with the door open, the door may move, but this is normal.

- 4** Insert the fork of the leg cover into the mounting holes to attach the cover.

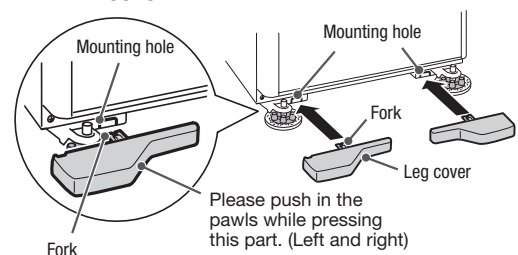

3

Cleaning the inside of the refrigerator → Pg.66~69

- Wipe it with a wet and soft cloth and then wipe it with a dry cloth.
- Wash the water supply tank, water filter and ice tray with water.
- ※ Do not wipe off the lubricant applied to the drawer rail or rail contact surface.
(The lubricant is compliant with the Food Sanitation Act)
- ※ Initially, the inside may smell like plastic. If you do not like it, ventilate the room so that the smell does not linger for long. (The smell will fade away gradually)

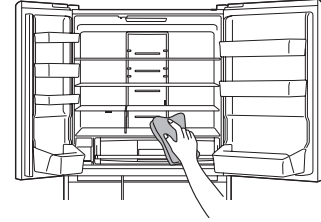

BEFORE USE

4

Plug the power cord.

It is not a problem to plug in the power cord soon after installing the refrigerator.

Use a wall outlet exclusively when connecting the power cord. (Alternating current 220 - 240V, rated 10A or more)

- Check that the power plug or the cord is not wedged between the back of the refrigerator and the wall in order to prevent the cord from getting hot.

Cooling inside the refrigerator starts.

- **It may take more than 4 hours** to cool well the inside of the refrigerator, depending on conditions such as the ambient temperature or storage state of foods. It may **take 24 hours or more in summer, etc.**
Do not put ice cream, uncooled foods or perishable foods in it until the inside of the refrigerator is cooled well.
- Perform **“Ice Maker Cleaning”** when using the automatic ice making function first. → Pg.68
- A series of ice making operation will start automatically after the inside of the refrigerator is cooled well.
(When using for the first time, it may **take 24 hours and more to make ice.**)
- If the inside of the refrigerator has a low temperature, cooling may not start until the elapse of about 10 minutes after inserting the power plug.

Notice

- **Pipes may require rust preventive measures.**

If your refrigerator is installed near a hot-spring or industrial area or a sewage pipe, the refrigerator pipe may corrode due to sulfidizing gas. Consult your dealer. If the pipe is blackened, any failure due to a gas hazard is not covered by our guarantee.

- **You will hear an operating sound after inserting the power plug. You may feel that the compressor or fan is noisy before the refrigerator is fully cooled.**
- Do not peel off the seal on the back or plastics at the lower part of the side.
- When a magnet or suction cup is attached on the side of the body or the surface of a door, it may leave a mark.
- When you attach a paper sheet on the door surface in a high ambient temperature, dew may form on the door surface, or the paper may absorb moisture.

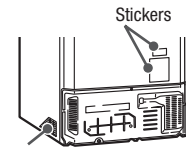

Plastic parts - Left/Right

LEARN NAME & FUNCTION OF EACH PART

Name of each compartment, temperature guide, and examples of stored food

Refrigerator Compartment → Pg.52
 Shelf: About 2°C ~ 6°C Pocket: About 2°C ~ 9°C

Daily foods

The temperature at the door pocket is slightly high.

Vacuum Compartment → Pg.54

+1°C About 0°C ~ 2°C **-1°C** **Off** About -2°C ~ 0°C

Ice Compartment
 → Pg.56
 About -19°C ~ -17°C

Ice Storage Space
 Ice made by Automatic Ice Maker
 [Only for R-ZX740K type, R-WX740K type]

Small Article Case
 Refrigerants or ice bars → Pg.57

Upper Freezer
 → Pg.58
 About -19°C ~ -17°C

Lower Freezer
 → Pg.58
 About -20°C ~ -18°C

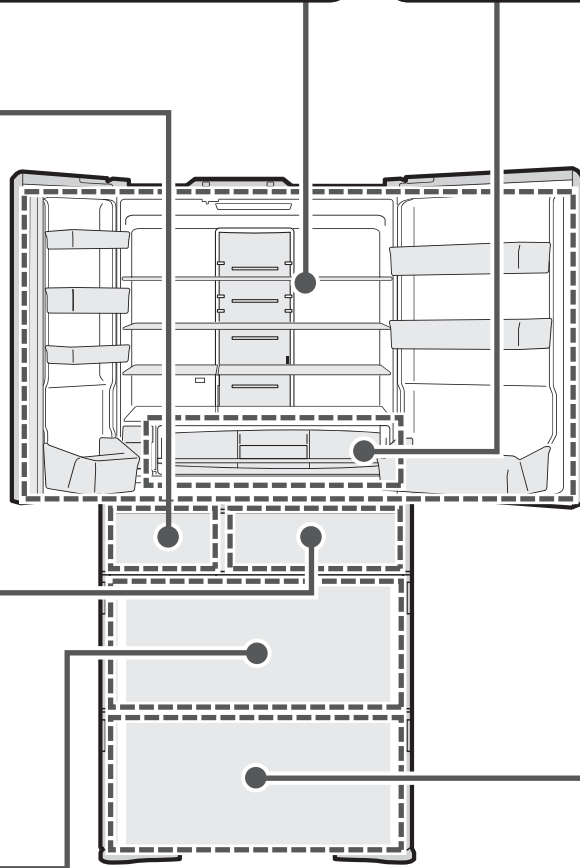

Vegetable Compartment
 → Pg.60

Upper/Lower space: About 4°C ~ 8°C

Upper Space	Lower Space
Unfinished vegetables, small vegetables, fruits, etc.	Leaf vegetables (spinach, Japanese Mustard Spinach etc.), large vegetables (cabbage, lettuce), etc.

Tall Storage Compartment: About 4°C ~ 9°C

Tall Storage Compartment
 Tall vegetables, PET bottle.

※ The above temperatures are standard values under the condition that the refrigerator is stable with no food stored and the door closed, at ambient temperatures of approximately 32°C, whereas the setting is “■■■” for both refrigerating chamber and freezing chamber. The above temperatures are those when “Sensor Cool” and/or “Veg” is not enabled.

Tip for storage

- Store foods in a loosely arranged way.
- It is recommended to wrap smelling foods.
- There is a rough guide on the weight of foods that can be stored in the refrigerator. → Pg.79

Functions of the Control Panel

The Control Panel is divided into two sections:
 Display Section in the upper part and Operation Section in the lower part.
 The Display and Operation Sections are normally unlit. Touch **MENU** to light it up.
 The Operation Section is a touch panel. Touch it to toggle the setting.

LEARN NAME & FUNCTION OF EACH PART

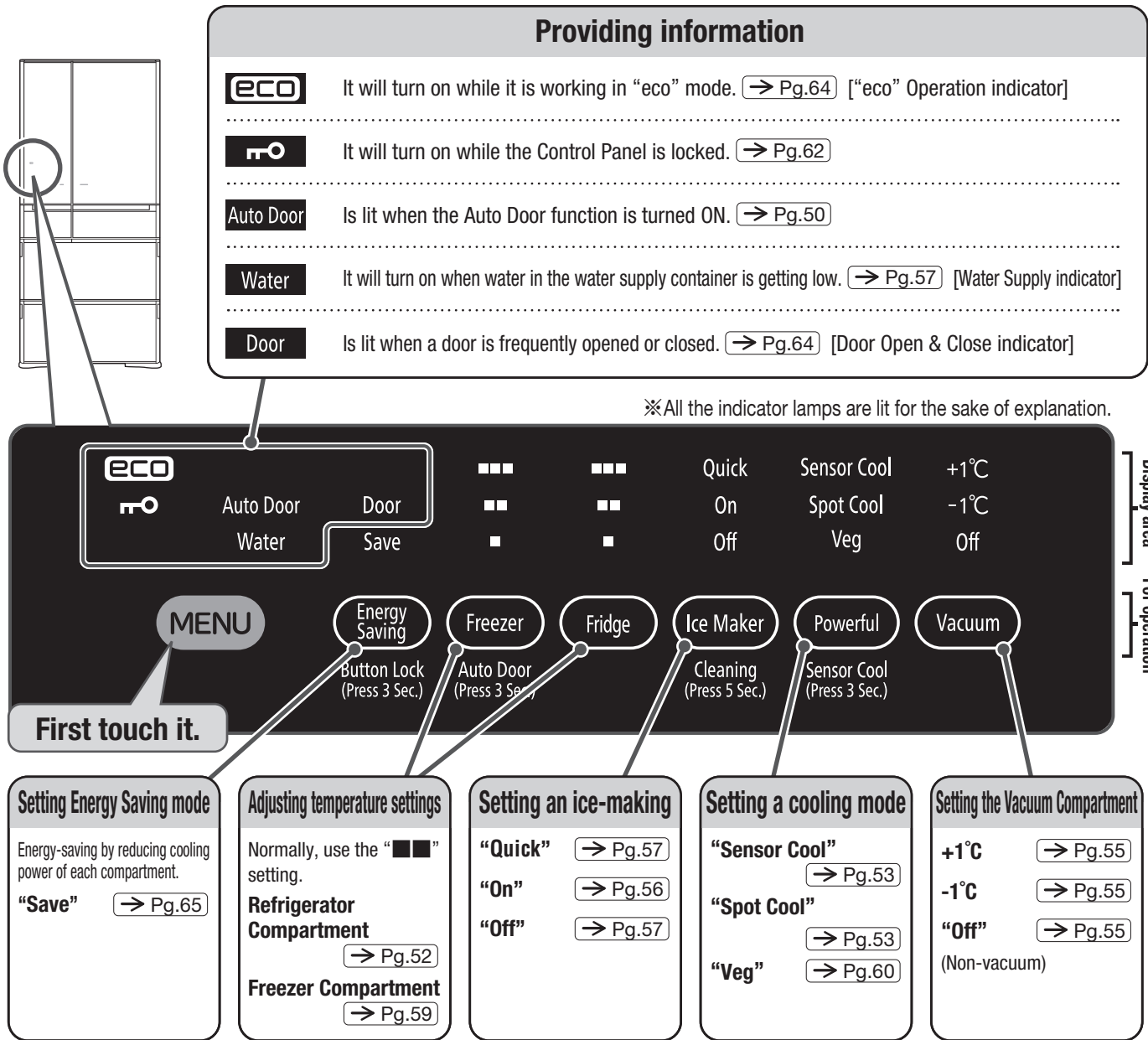

Notice

- Touch **MENU** to light up the Control Panel and display the current settings. The current settings are also displayed when a door of the Refrigerator Compartment is opened.
- Touch **MENU** again at the end of operation to turn off the light of the Display and Operation Sections.
 Even if you do not touch **MENU**, the display and Operation Sections go out after approx. 40 seconds for energy savings, except for the indicators of the "Energy Saving" mode, "Quick", "Off (Stop Ice Making)", "Water", "Off (Non-vacuum)", ["eco" Operation], and [Door Open & Close].
- The Display and Operation Sections are lighted up when a door of the Refrigerator Compartment is opened. They go out approx. 15 seconds after the door is closed.
- Response of the touch panel may change depending on the surrounding temperature, humidity, physical condition of the user or operation status of the adjoining electric product.
- Release a finger and touch the panel again if the panel does not respond after touching it. False detection may occur (it may be kept pressed) if the time interval between key touches is too short. Response of the touch panel does not improve even if you touch it strongly.
- The panel may not respond if it is wet or dirty. After removing dirt with a wet cloth, wipe off the water with a dry cloth.
- While a door of the Refrigerator Compartment is left open or the Display Section is blinking, the Operation Section remains inactive even if you touch a button. The display is blinking. Please see (→ Pg.73).

Auto Door

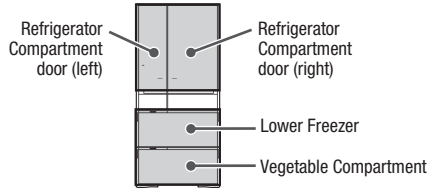

■ **Auto Refrigerator Door** You can open the door easily by touching the door lightly with your fingers thanks to the Auto Refrigerator Door function. (Only for R-ZX740K type)

■ **Auto Drawer** Auto Drawer function helps you to pull out the case easily even if it is heavy with plentiful foods in.

Warning

- When an infant child may use the Auto Refrigerator Door or the Auto Drawer to make mischief, please stop the Auto Door function.

Caution

- When an infant child may use the Auto Door to make mischief, please stop the Auto Door function.
- Do not operate the Auto Refrigerator Door Switch when another person is in front of the refrigerator (which may lead to personal injury unexpectedly by the opening door).
- Do not bring your foot too near the refrigerator when you press the Auto Drawer switch of the vegetable compartment. (You may knock your foot against the door and may cause injury)
- Do not put any item on the refrigerator.
- Do not hold any portion of the door other than the handle. (This can cause pinching of fingers, which could result in injury.)
- Do not press the Auto Drawer switch with your knee.

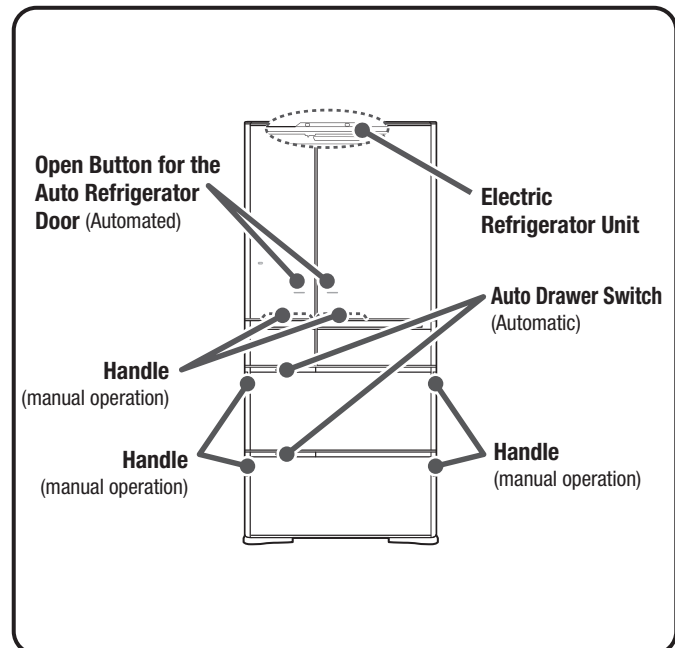

Setting the Auto Door

You can enable or disable the Auto Door function. The function is enabled when you purchase the product.

- 1** Touch **MENU** button on the Control Panel to turn on the indicator lamp.

All indicator lamps turn on, and then the current settings are displayed.
- 2** Press and hold **Freezer** for three seconds or more until the preset sound (long beep) is heard to turn on the “Auto Door” indicator lamp.

(At the time of purchase / At the time of setting)
- 3** Touch **MENU** on the Control Panel to turn on the indicator lamp, press and hold **Freezer** for 3 seconds or more until the preset sound (2 beeps) is heard to turn off the “Auto Door” indicator lamp.

Notice

- When the Auto Door function is turned “off”, open the door with the handle.
- The Auto Door function cannot be disabled for either Auto Refrigerator Door or Auto Drawer only.

Using the Auto Refrigerator Door



When touching the Open Button for the Auto Refrigerator Door, the operation sound is heard, and then it will open automatically.

Request

When closing it, use the handle with your hand to do so.
The door does not close automatically.

Notice

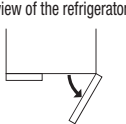
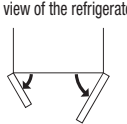
- The Auto Refrigerator Door does not open when either the “Ice Compartment” or the “Upper Freezer” is opened to prevent hands from being caught.
- The Auto Refrigerator Door is a function to reduce load incurred at the beginning of the opening of the door of the Refrigerator Compartment. Opening angle of the door may vary or the door may slightly go back, depending on installation conditions of the refrigerator or how beverages or foods are stored in the door pocket, but this is not an abnormal.
- After touching the Open Button for the Auto Refrigerator Door, the operation sound may be heard when opening the door, but this is not malfunction.
- If the Open Button for the Auto Refrigerator Door is wet or dirty, it may not respond. Use a wet cloth to wipe off dirt, and then wipe it with a dry cloth.
- If you touch the Open Button of the Auto Refrigerator Door and its neighboring part at the same time, or you touch it for about one second or more, the Auto Refrigerator Door may not be opened automatically.
- Hold the handle with your hand to open the door while the Auto Refrigerator Door function is disabled.

How to open the Auto Refrigerator Door	Opening one door on either side 	Open both doors at a time 
How to operate	Touch the Open Button of the door to be opened  * Operate with a finger.	Slide your finger from one edge of the Open Button to the other.  (Doors will open in turn from the side you touch.)
Operation sound of the Auto Refrigerator Door	1 beep	Long beep

AUTO DOOR

Manually open and close the Refrigerator Door.

When opening a door

- Do not hold the swing partition to open the door.
(It may make it impossible to open the door.)

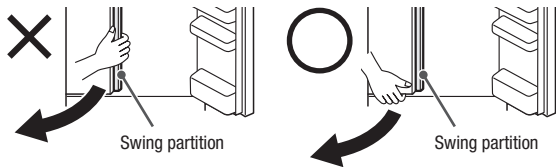

When closing a door

- Do not close the door with the swing partition erected.
(It may make it impossible to close the door completely.)



Request

Do not apply excessive force to a door, by, for example, opening it with too much force or leaning against the opened door. Doing so may damage it.

Using the Auto Drawer

Press the Auto Drawer to automatically open the drawer.

When you close it, push the handle on the right/left to close.
The door does not close automatically.

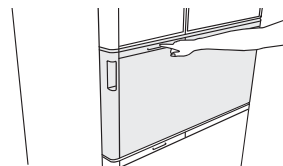

Notice

- This function is to reduce an initial load when pulling out the Auto Drawer. The Auto Drawer can be pulled out by approx. 15 cm or more. The length may vary depending on installation conditions of the refrigerator, or the door may go back a little after the door is opened automatically, but it is normal.
- “Lower freezer” and “vegetable compartment” cannot be electrically opened at the same time.
- When one of the “lower freezer” and “vegetable compartment” is open, the Auto Drawer function does not work.
- A sound is heard when you press the Auto Drawer switch. This is not abnormal.
- Wipe off spilled liquid and others on the Auto Drawer switch immediately.
Or Auto Drawer switch may fail to work, causing the door open disorderly.
- Hold the right and left handles with your hand to pull the drawer out while the Auto Drawer function is disabled.

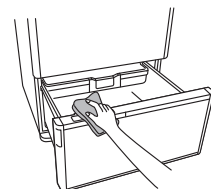

REFRIGERATOR COMPARTMENT

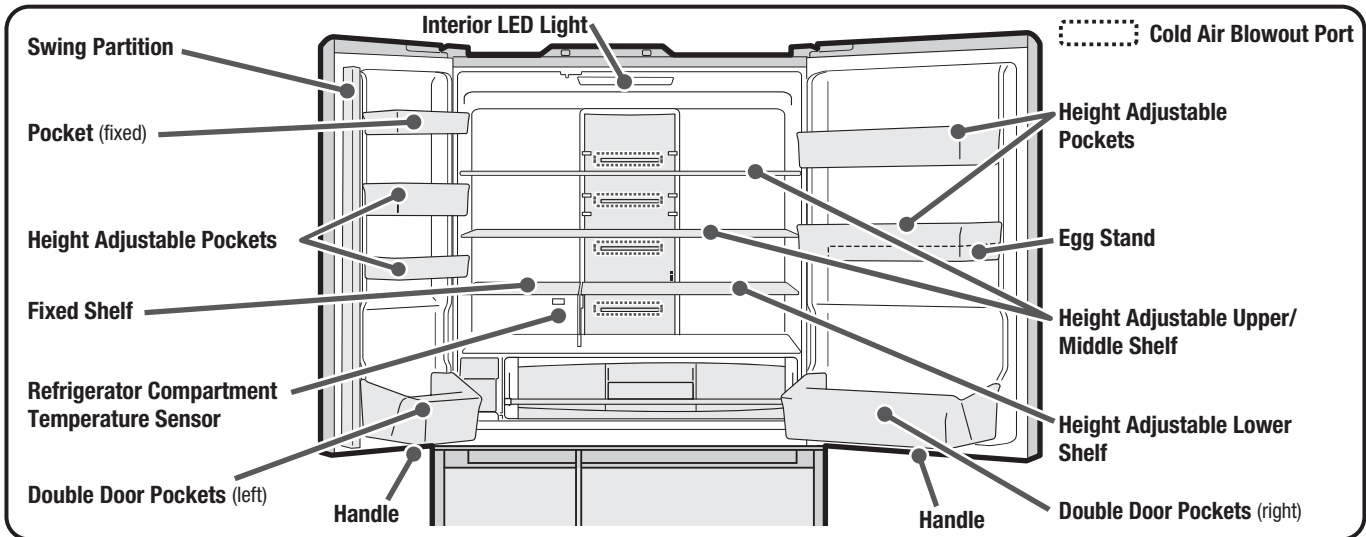
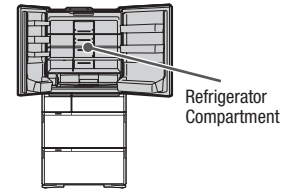

Request

- Food containing a lot of water or canned beverage placed in front of the cold air blowout port may be frozen or burst. Avoid doing so. In particular, they are likely to be frozen if "Sensor Cooling" is enabled. A lid or plastic wrap can prevent freezing.

Adjusting temperature in a refrigerator compartment

The temperature is set to "■■■" at the time of purchase. Use the setting on a daily basis.

If you feel the inside is not cooled enough in summer, select "■■■■".

1

Touch **MENU** button on the Control Panel to turn on the indicator lamp.

All indicator lamps turn on, and then the current settings are displayed.

2

Touch **Fridge** button to set the temperature as you like.



Guide for Refrigerator Compartment temperatures:

"■■■■" sets a temperature lower than that for "■■■" by about 1 to 3 °C.

"■" sets a temperature higher than that for "■■■" by about 1 to 3 °C.

Request

- When you use "■■■■" for a long time during winter, food may be frozen. If the inside is too cool, use "■■■" or "■".

Notice

- The temperature may change depending on the operation states.
- If you adjust the temperature more finely. (→ Pg.62)
- The "■■■■" setting of the Freezer Compartment consumes more energy than the "■■■" setting by approximately 20%.
- Changing the temperature setting of the Refrigerator Compartment also changes the temperature in the Vacuum Compartment.

Adjust the height of a pocket/shelf

You can adjust the position of the pocket and the shelf depending on size of foods or beverages.

For how to remove/attach, see (→ Pg.70).



CAUTION

■ Handling the glass shelves

- Avoid a high impact on the glass shelf. (A broken glass may cause injury)
- Be careful to attach the glass shelves because they are heavy.

■ Height adjustable upper shelves / Height adjustable middle shelves / Height adjustable lower shelves / Height adjustable pockets

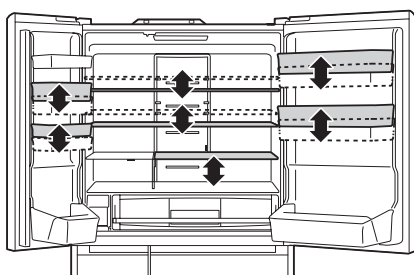

R-ZX740K Type
R-WX740K Type
R-WX620K Type

- State at the time of purchase

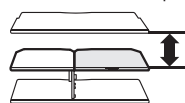

- Storage of pans, etc.

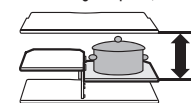

Mount the shelf board at the middle level.

- Storage of milk carton, etc.

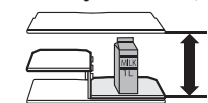

Mount the shelf board at the lower level.

R-WX670K Type

- State at the time of purchase

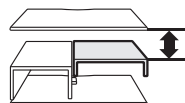

- Storage of pans, etc.

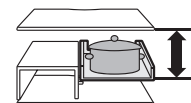

Turn the upside of the shelf board down and mount it at the upper level.

- Storage of milk carton, etc.

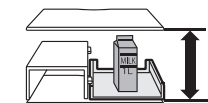

Turn the upside of the shelf board down and mount it at the lower level.

When keeping food at lower temperatures (using the “Sensor Cooling” function)

“Sensor Cooling” has two functions:

- Lower the temperature of the “Low-temperature Refrigeration Space” (Disabled: About 2 to 6 °C
⇒ Enabled: About 0 to 3 °C)
Suitable for storing prepared daily dishes.
- Upon placing a hot food in the “Automatic Rapid Cooling Space”, a sensor detects the temperature of the food and cools it rapidly.
Even if you put a hot pan, the refrigerator can cool it rapidly, while reducing the impact on other foods.
To put a pan in the “Automatic Rapid Cooling Space”, cool it down to a temperature at which one can touch it with bare hands (50 °C or less). This can prevent burn injury or shelf deformation.

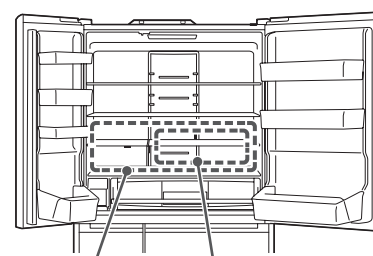

Low-temperature Refrigeration Space Automatic Rapid Cooling Space

Notice

- Enabling “Sensor Cooling” enables both of the “Low-temperature Refrigeration” and “Automatic Rapid Cooling” functions at the same time. Either of the functions cannot be enabled.
- When “Sensor Cooling” is enabled, the refrigerator consumes more power than when disabled. The operating sound may be noisier.
- When “Sensor Cooling” is enabled, temperature in the Double door pockets is also lower than when disabled.
- When the Refrigerator Compartment is set to “■” or “Energy Saving”, the temperature in the entire Refrigerator Compartment is higher than that for “■■■” by about 1 to 3 °C. If the Refrigerator Compartment is set to “■■■■”, the temperature in the entire Refrigerator Compartment is about 0 to 3 °C.
- In the “Automatic Rapid Cooling” mode, the sensor may not be able to detect the temperature of food, depending on the amount or temperature of the food. However, when “Sensor Cooling” is enabled, the Low-temperature Refrigeration Space is lower than when disabled, allowing you to cool food more quickly.
- The above temperature in the “Low-temperature Refrigeration Space” is based on the assumption that the surrounding temperature is about 32 °C and the temperatures of the Refrigerator and Freezer Compartments are stable at the “■■■” setting.

How to enable “Sensor Cooling”

1

Touch **MENU** button on the Control Panel to turn on the indicator lamp.

All indicator lamps turn on, and then the current settings are displayed.
The Sensor Cooling is set to “Off” at the time of purchase.

2

Touch and hold **Powerful** for at least 3 seconds until the setting sound (beep) sounds to light “Sensor Cool”.

“Sensor Cool” is valid until it is released.

Cancel

Touch **MENU** on the Control Panel to turn on the indicator lamp, touch and hold **Powerful** for at least 3 seconds until the setting sound (2 beeps) sounds to turn off the “Sensor Cool”.

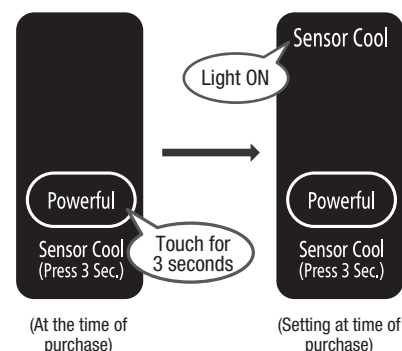

REFRIGERATOR COMPARTMENT

When you want to quickly cool the foods. (using the “Spot Powerful Cooling” function)

When you want to quickly cool the foods, operate to strengthen the cooling of the “Automatic Rapid Cooling Space”.

It can reduce the time for cooling warm foods and the removal of heat just after cooking.

It is recommended when you want to quickly cool a lunch box or drinks as well as vegetables before going out just after cooking. When storing warm foods, cool it to a temperature that can be touched by hand (50 °C or less) and then put it in. It can prevent burns or shelf deformation.

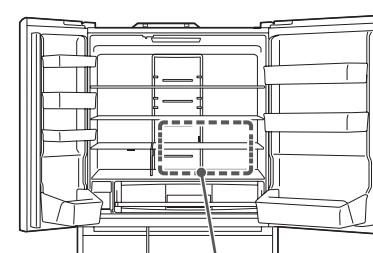

Automatic Rapid Cooling Space
Spot Powerful Cooling Space

Notice

- When “Spot Powerful Cooling” is set, the amount of power consumption is greater than when it is released.
- Continuous use of “Spot Powerful Cooling” may freeze foods in the refrigerator.
- It can be also used even when the “Sensor Cooling” is set.

How to enable “Spot Powerful Cooling”

1

Touch **MENU** button on the Control Panel to turn on the indicator lamp.

All indicator lamps turn on, and then the current settings are displayed.
The Spot Powerful Cooling is set to “Off” at the time of purchase.

2

Touch **Powerful** button to turn on “Spot Cool” indicator lamp.

The operation is automatically stopped in around 60 minutes and the indicator “Spot Cool” display turns off.

To cancel it

Touch **MENU** button on the Control Panel to turn on the indicator lamp, and touch **Powerful** button to turn off “Spot Cool” indicator lamp.

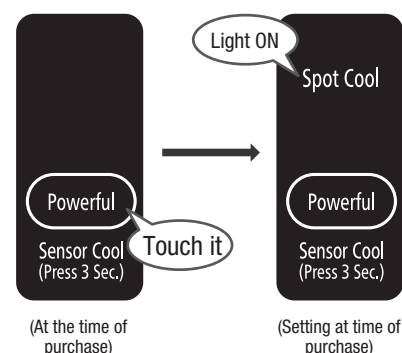

53

VACUUM COMPARTMENT

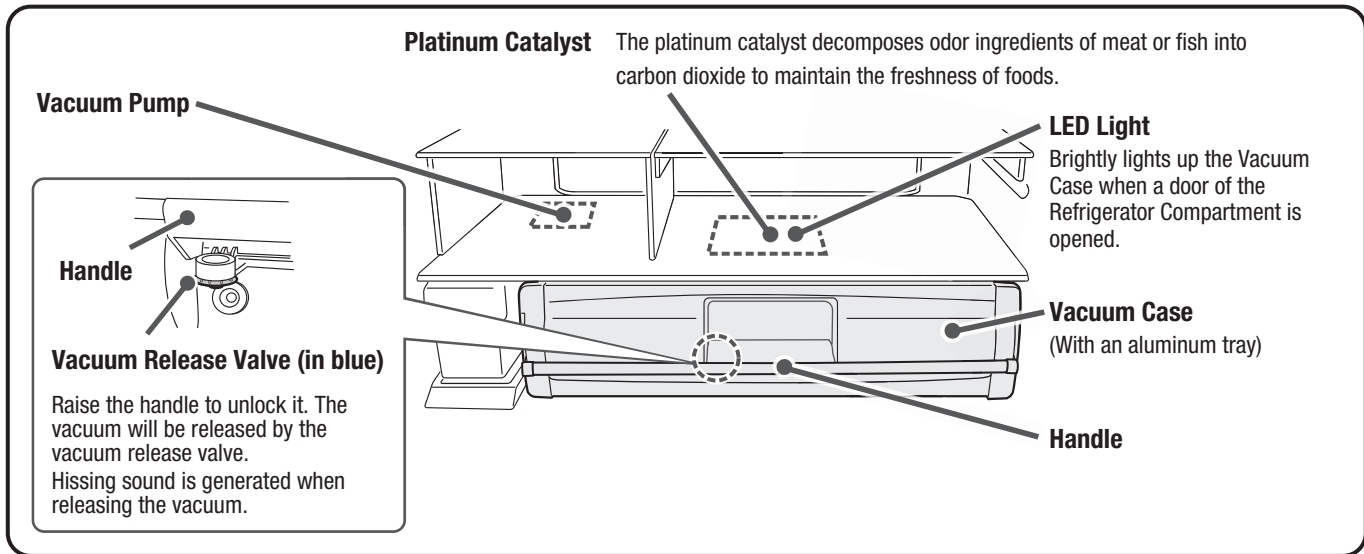
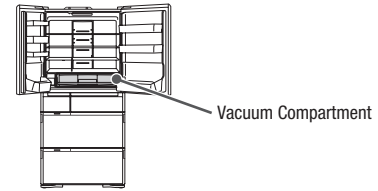

Key points for using appropriate temperatures

Switch between “+1°C” and “-1°C”, depending on the food to be stored.

※ At the time of purchase, the refrigerator is set to the “-1°C”.

+1°C (About 0°C – 2°C)	<ul style="list-style-type: none"> ● Dairy products ● Precut vegetables and fruits ● Food which form air bubbles inside if frozen
-1°C (About -2°C – 0°C)	<ul style="list-style-type: none"> ● Meat, processed meat ● Fish, seafood, boiled fish paste ● Thawing meat or fish <p>• Foods containing a lot of water may be frozen.</p>
Off (Vacuum off) (About -2°C – 0°C)	<p>The vacuum function is disabled. This setting is recommended to store food in “sealed bags” or “sealed plastic containers”, which requires caution in storing. Foods with a high water content may freeze because this is an ice-temperature compartment.</p>

Notice

- The vacuum effect will not be changed even if foods are wrapped. If you are concerned about the transfer of smell, be sure to wrap a food item in question.

Caution

- Foods high in water content may freeze if ambient temperature is low.
- When putting food materials that should be stored at subzero and chiller temperatures together, set the temperature to “+1°C” to prevent freezing.
- The temperatures of the Vacuum Compartments also change if the temperature of Refrigerator/Freezer Compartment is set to “■■■■” or “■”.
- **Do not put too much food or too many containers in the Vacuum Compartment.** Doing so may make it difficult to pull out the Vacuum Case.

Change the settings of the Vacuum Compartment

1 Touch **MENU** button on the Control Panel to turn on the indicator lamp.

All indicator lamps turn on, and then the current settings are displayed.

2 Touch **Vacuum** button to change the settings as you like.

The display switches in sequence as shown below every time the button is touched.

The temperature is set to “-1°C (Subzero)” at the time of purchase.

Caution

- The “Off” indicator lamp continues to be lit during the “Off” operation. The display will be turned off after about 40 seconds for energy saving, but the function that is set once will remain effective.

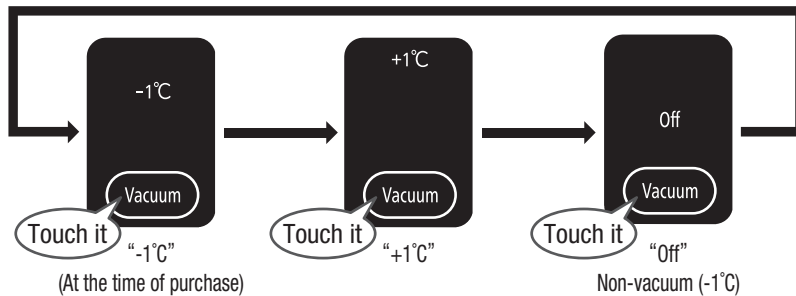

※ The above values are obtained with an ambient temperature of 32°C, the temperature in the Vacuum compartment in a stable state with no food stored and no door opened.

VACUUM COMPARTMENT

When opening/closing the door of the Vacuum Case

When opening the door

1 Pull up the handle to unlock.

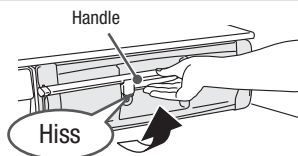

- ※ It takes about three to four minutes for the Vacuum Case to be vacuumed after the vacuum pump starts to operate. The hissing sound may not be heard when the Vacuum Case is opened within four minutes.

- ※ If you pull out the Vacuum Case without opening the door on the left/right, it may cause damage to parts.

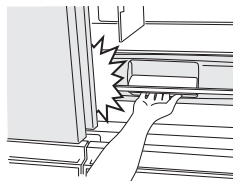

2 Pull out the Vacuum Case.

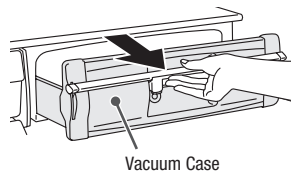

- ※ The hissing sound indicates that vacuum is being released. Thus, the Vacuum Case cannot be drawn out while the sound is heard. Draw it out after the sound is no longer heard.

When closing the door

1 Push the Vacuum Case back to the end.

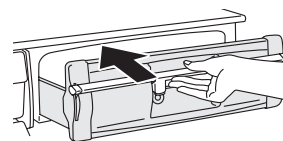

2 Press down the handle to lock.

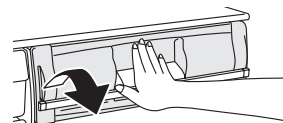

Caution

- The Vacuum Case is not put in the vacuum state unless the handle is pushed down securely.
- Closing the door of the Refrigerator Compartment without locking the handle may damage parts or food or form a clearance between the doors, which reduces cooling performance.

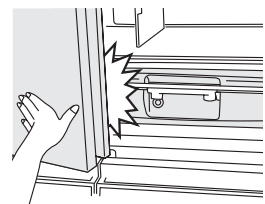

Request

- If a part of the gasket is stuck together, the vacuum state cannot be maintained. If it is stuck together, please remove it. Since it is difficult to see the left and right sides and the bottom, remove the Vacuum Chilled Case and check it. (→ Pg.70)
- Dew and/or frost may be formed in the sealed Vacuum Compartment due to moisture contained in food or in the air. Soak a soft cloth in lukewarm water and wipe off the dew and/or frost with the cloth. (Attached dew, frost or ice does not reduce performance.)
- If you want to avoid dew, frost or ice, stored food should be wrapped with plastic wrap.
- Wipe water or soup spilled in the compartment soon, if any.
- The platinum catalyst needs no replacement. Do not remove it.

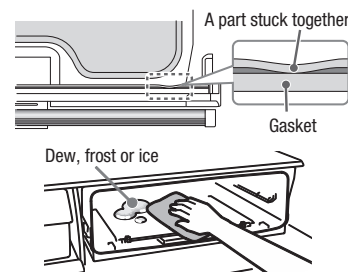

ICE COMPARTMENT (AUTOMATIC ICE MAKER)

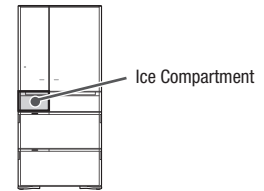

Water Supply Container
(Approx. 1.0 L)

Control Panel

Ice Case

Ice Compartment

How to make Ice

Perform "Ice Maker Cleaning" when making ice for the first time or for the first time in a week or more. → Pg.68

- 1 Touch **MENU** button on the Control Panel to turn on the indicator lamp.**

All indicator lamps turn on, and then the current settings are displayed.
- 2 Touch **Ice Maker** button to turn on "On" indicator lamp.**

The "On" mode is set to "On" (light on) at the time of purchase.
- 3 Take off the Water Supply Container.**
- 4 Open the lid and add water.**

※ Do not pour water into it beyond the full water line.
- 5 Replace the Water Supply Container.**

Push it straight beyond the "Container set position" line completely.

Ice cubes are not produced unless the water supply tank is pushed into the rearmost position.

※ Water may spill out if the water supply container is inclined. Wipe off spilled water immediately.

Request

- **WARNING:** fill with potable water only.
- Water for ice making is according to your drinking standard. Quality of tap water may vary in different countries. Please check and verify with your local authority.
- Change water and clean the container at least once a week for hygiene purposes. → Pg.69
- If the ice made of mineral water containing a lot of mineral ingredients is put into water, white powder may come out, however this is due to those mineral ingredients and harmless.
- Furthermore, these types of water are easily contaminated with bacteria. Please wash the container usually once 3 days.

Mineral water
(Hardness: 100mg/L or less)

Filtered water or
boiled water

Well water
(Required to satisfy the appropriate
water quality standard)

- Do not use the following ones because they may cause malfunction, deformation or sticking ice.

Juice drink

Sports drink

Carbonated drink

Tea

- 6 Ice-Making starts automatically.**

 - When ice cubes reach the Container-full line, the automatic ice-making function is suspended. The function automatically resumes when ice gets low.
 - When the Ice Case contains no ice cube, you may hear a large sound when ice cubes fall from the Ice Tray.

Stored ice amount and ice-making time

Model	R-ZX740K type, R-WX740K type, R-WX670K type, R-WX620K type	
Stored ice amount	Normal operation	About 90 pcs
	Ice is leveled	About 150 pcs
Time for one-time ice making (12 cubes)	Normal "On"	About 110 minutes ~ 140 minutes
	"Quick"	About 80 minutes

※ The above values are obtained with an ambient temperature of 30°C, the temperature in each compartment set to "■" and no door opened/closed.

Notice

- Ice cubes stacked unevenly may suspend ice-making even if they are not enough. Make them flat.
- It may take longer time to make ice in the following cases:

- It is used for the first time (it may take 24 hours or more).
- When the temperature of the Freezer Compartment is set to "■".
- Large volume of foods is stored in the refrigerator at a time.
- It is set to the "Energy Saving" mode.
- In case of power outage.
- The door is opened/closed frequently.
- After the ice tray is cleaned.
- When the door of the Freezer Compartment / Ice Compartment is not closed completely.
- With the low ambient temperature in winter, etc.

Request

- It is set to the "On" or "Quick" mode, do not put frozen food other than the ice cubes made by the Automatic Ice Maker in Ice Storage Space. (Doing so may prevent ice-making, damage parts or bring a part of the ice maker into contact with food, which may prevent the opening of the door.)
- Open or close the Ice Compartment door slowly. Failing to do so may cause ice cubes to drop from the Ice Case onto the Lower Freezer.

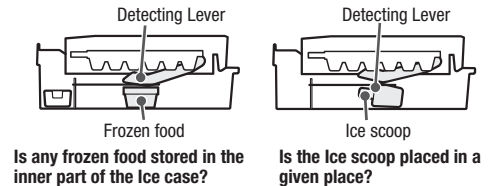

Quick Ice Making

1 Touch **MENU** button on the Control Panel to turn on the indicator lamp. All indicator lamps turn on, and then the current settings are displayed.

2 Touch **Ice Maker** button to turn on "Quick" indicator lamp. Ice cubes are made in a shorter time than that of "On" operation. 12 ice cubes are made by one ice-making operation. "Quick" operation ends automatically in about 7 hours, and it is changed to "On" mode.

Notice

- "Quick" indicator continues to be lit during the "Quick" operation. The ["eco" operation indicator lamp] is not turned on.
- While "Quick" is operating, cooling for the freezer compartment is given priority, so the temperature of the refrigerator compartment is likely to increase when the doors are opened and closed frequently.

Stop Ice Making

1 Touch **MENU** button on the Control Panel to turn on the indicator lamp. All indicator lamps turn on, and then the current settings are displayed.

2 Touch **Ice Maker** button to turn on "Off" indicator lamp. ※ If you set to "Off" for 1 week or more, maintain the Automatic Ice Maker. → Pg.68, 69

Notice

- "Off" indicator continues to be lit during the "Off" operation.

Small Article Case (Only for R-ZX740K type, R-WX740K type)

Stored foods	Refrigerants or ice bars
---------------------	--------------------------

Notice

- When putting something hot, ice in the Ice Storage Space may melt or ice-making may take a long time.
- Ice cream may be soft due to indirect cooling.
- Be sure to close the lid. Do not put an object which is too large to close the lid.

Water Supply indicator

Water indicator lamp comes on when water in the water supply container is getting low. Replenish the container with water.

When you open/close the door at left door of the Refrigerator Compartment, the lamp **Water** will be turned off. If no water supplies, it will be turned on again. (after 3 hours as the maximum)

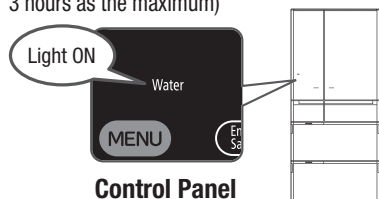

Notice

- **Water** indicator lamp remains off when "Off" is selected for automatic ice making.
- **Water** may come on regardless of water level if the water supply container is not placed properly. Push in the container straight and completely if the indicator lamp comes on.
- Even in the "On" mode, the **Water** indicator lamp may not be lit if the tank is full.

When the "On" indicator blinks, or the "■ ■ ■" and "■" indicators and the "■" indicator blink

If the ice maker's "On" indicator blinks, the ice tray might have come into contact with food inside the ice container.

Empty the Ice Case once, and then start the "Ice Maker Cleaning". → Pg.68

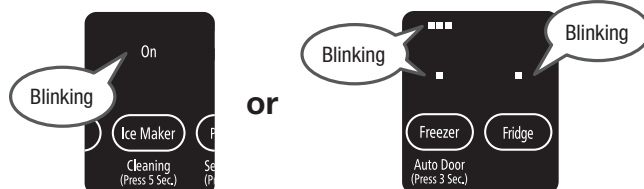

ICE COMPARTMENT (AUTOMATIC ICE MAKER)

FREEZER COMPARTMENT

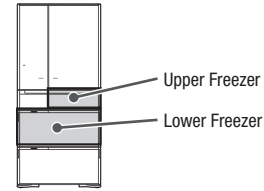

Upper Freezer

Use it to keep daily foods or partially used food.

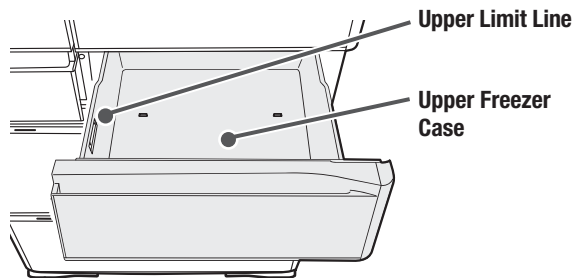

Caution ● Don't put foods beyond the upper limit line.

Lower Freezer

3-layer freezer case provides you with large storage space compartment and convenient reach of your freeze food items.

It is suitable for storing the food preserved for a long time and the food that melt easily such as ice cream.

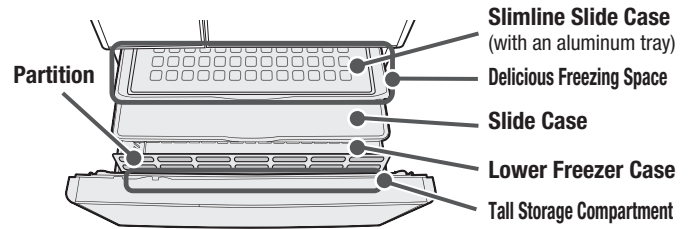

Caution ● Do not remove the Slimline slide case and the partition.

Stored foods

Upper Freezer		Frozen packages, sealed containers, bread, etc.
Lower Freezer	Slimline Slide Case	Small-item and frozen food, etc. <div style="border: 1px solid black; border-radius: 10px; padding: 2px; display: inline-block;">Delicious Freezing Space</div> When you want to freeze meat, fish or rice quickly
	Slide Case	Freezing bag and airtight container etc.
	Lower Freezer Case	Frozen food and bread, ice cream etc. <div style="border: 1px solid black; border-radius: 10px; padding: 2px; display: inline-block;">Tall Storage Compartment</div> PET bottle for freezing, etc.

When storing food

Store food according to its type or size. As for the height of the foods to be stored, please use the reference standard line as a guide for upper freezing point, and the end face as a guide for other cases.

Store food such that it does not comes into contact with the upper case or partition.

Otherwise the door may not be closed completely, which leads to inefficient cooling action, and also may cause damage to the food or cases.

Caution

- Do not store any PET bottle in the Slimline slide case. It may not be taken out because it expands when it is frozen.
- Do not use with the slide case removed. Food may drop to the inner part of the case, and as a result, the door may not close completely.
- Store only food which can be frozen such as PET bottle which can be stored in freezer.

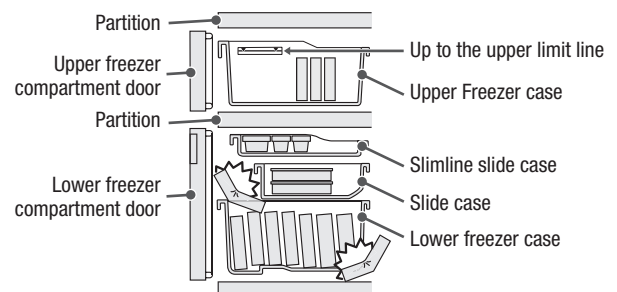

Adjusting temperature in a refrigerator compartment

The temperature is set to “■■■” at the time of purchase. Use the setting on a daily basis.

If you feel the inside is not cooled enough in summer, select “■■■■”.

1 Touch **MENU** button on the Control Panel to turn on the indicator lamp.

All indicator lamps turn on, and then the current settings are displayed.

2 Touch **Freezer** button to set the temperature as you like.



Guide for Freezer Compartment temperatures:

“■■■■” sets a temperature lower than that for “■■■” by about 2 to 4 °C.
“■■” sets a temperature higher than that for “■■■” by about 2 to 4 °C.

Request

- If the inside is too cool, use “■■■” or “■■”.

Notice

- The temperature may change depending on the operation states.
- If you adjust the temperature more finely. [→ Pg.62](#)
- The “■■■■” setting of the Freezer Compartment consumes more energy than the “■■■” setting by approximately 20%.
- Changing the temperature setting of the Freezer Compartment also changes the temperature in the Ice Compartment.

Using the Delicious Freezing

The large aluminum tray helps freeze food more quickly.

Just by placing food in the Delicious Freezing Space, the sensor detects its temperature and automatically switches cooling operation.

Wrap a food item with food plastic film or put it in a freezing bag and then place it on the aluminum tray. Dividing a food item into small lumps and flattening them allows the center of each lump to be frozen quickly and facilitates the taking-out of the frozen food.

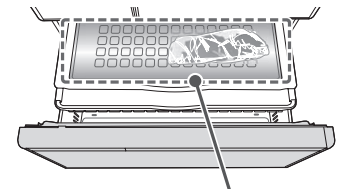

Delicious Freezing Space

Notice

- Food can be frozen more efficiently if put them in close contact each other on the large aluminum tray without stacking.

FREEZER COMPARTMENT

VEGETABLE COMPARTMENT

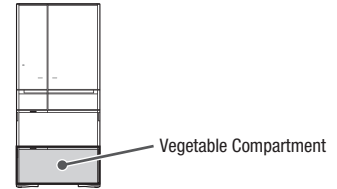

Platinum Catalyst Odor ingredients of meat or fish and/or ethylene gas from vegetables is decomposed into carbon dioxide to maintain the freshness of foods.

Locking Handle (Containing platinum catalyst)
※ Do not remove it.

Upper Case

Lower case

Partition ※ Do not remove it.

Partition ※ Do not remove it. (only for R-ZX740K type, R-WX740K type)

Moisture Unit ※ Do not remove it.

Moisture Cover ※ Do not remove or forcefully move it.

Tall Storage Compartment

Upper Space

Lower Space

Door of the Vegetable Compartment

Partition

Stored foods

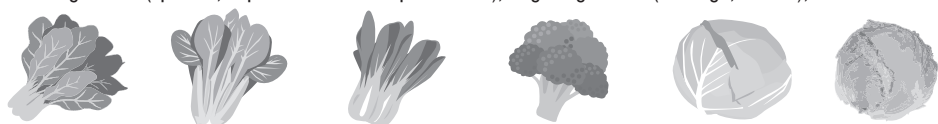
Upper space	Unfinished vegetables, small vegetables, fruits, etc.
Lower space	Leaf vegetables (spinach, Japanese Mustard Spinach etc.), large vegetables (cabbage, lettuce), etc. 
Tall Storage Compartment	Tall vegetables (cucumber, asparagus etc.), 2L PET bottle, etc.

Adjusting temperature of Vegetable Compartment [Vegetable Compartment (MAX)]

1 Touch **MENU** button on the Control Panel to turn on the indicator lamp.

All indicator lamps turn on, and then the current settings are displayed.

2 Touch **Powerful** button to turn on "Veg".

Food is cooled at temperatures lower than usual (Normally, approx.4°C to 8°C, → "Veg": 2°C to 6°C)

※ The above temperatures are provided as a guide when the inside temperatures are stabilized at the ambient temperature of 32°C under the conditions that: The temperatures of the Refrigerator and Freezer Compartments are set to "■" and the doors are closed without storing food.

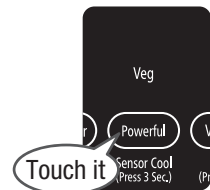

Notice

- Although the indicator goes off about 40 seconds for energy savings, the setting is valid until it is cancelled. Meanwhile, note that while the "Veg" setting is on, the ["eco" Operation indicator lamp] does not turn on.

Cancel

Touch **MENU** button on the Control Panel to turn on the indicator lamp, and then touch **Powerful** button to turn off the "Veg" indicator lamp.

Notice

- If foods are kept in the "Veg" for a long time, vegetables high in water content may freeze.
- When setting "Energy Saving" mode during the "Veg" mode, the cooling function is shifted to weaker cooling effects from the "Veg".
→ Pg.65
- Temperature in the case may be lowered when the outdoor temperature is low.

Request

In the following cases, cancel the "Veg" setting:

- You care about dents on or discoloration of the surfaces of low-temperature sensitive vegetables, such as eggplant.
- You care about dew condensation in the Vegetable Compartment.

When storing food

Store food according to its type or size.

- **Pay attention to the height of food to be stored.**
 - The door may not be closed securely, which leads to inefficient cooling. It may also damage food, the case and the Moisture Cover.
 - Some PET bottle can't be stored, depending on its type.
- **Do not use the refrigerator with the Upper Case removed.**
 - Doing so may cause food to drop into the rear of the case, which may prevent the closing of the door.
- **Do not push more food or beverage than can be accommodated.**
 - The partition, the cases or the Moisture Cover may be damaged.

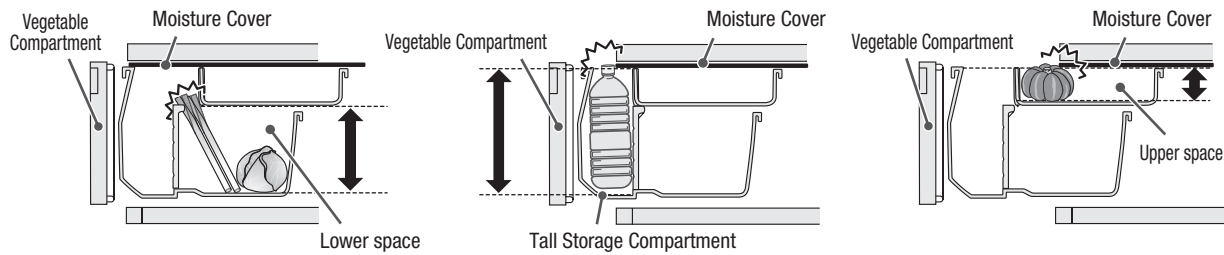

VEGETABLE COMPARTMENT

Tips for storing vegetables

Types of food recommended to be kept at room temperature

- We recommend that the following types of food be kept in a cool location away from direct sunlight: garlic, onion, potatoes, sweet potatoes, squash, and whole (uncut) pumpkins.



Risk of damage due to low temperatures

Some foods might change color or lose flavor if stored in the vegetable compartment for an extended period of time. Other types of food might lose their vitamin C content, grow mold, or spoil.

- **Vegetables:** Tomatoes, green pepper, cucumber, eggplants, green beans, sweet potatoes, okra, etc.
- **Fruits:** Bananas, pineapple, mangos, papayas, avocados, lemons, etc.



Above foods become delicious by cooling in the refrigerator for a short time before eating.

Request

- If the vegetable compartment contains only a few items, it might not be able to maintain a high level of moisture. In such cases, wrap the items to be stored, in plastic wrap to prevent them from drying out.
- The moisture level of the vegetable compartment is relatively high. As such, depending on the amount and types of vegetables stored in the compartment, moisture might condense on the surfaces of containers, on the moisture-retention unit and cover, or on items stored in the compartment. If you are concern about moisture condensing on the surface of foods, wrap foods in plastic wrap before storing them in this compartment.
- If the moisture-retention unit is blocked (for example, by food in containers or bags), moisture is more likely to condense. Be sure to store food in a way that does not block the moisture-retention unit.
- Water accumulating in the container might cause food to spoil faster. Use a sponge or dishcloth to wipe up any water that accumulates.
- Dried food (rice, laver, etc.) stored in the vegetable compartment might absorb moisture. To prevent this, put the dried food in a sealed container or bag before storing it in the vegetable compartment.

Notice

The temperature of the space for tall items is slightly higher than that of other containers.

VARIOUS FUNCTIONS

Fine adjustment of the temperature (Refrigerator Compartment / Freezer Compartment)

Temperature settings for Refrigerator and Freezer Compartments can be more finely adjusted by 11 levels.

1 Open the door of the Lower Freezer Compartment.

2 Touch **MENU** button on the Control Panel to turn on the indicator lamp.

All indicator lamps turn on, and then the current settings are displayed.

3 Press down **Fridge** button for 5 seconds or more until 1 beep is heard.

4 Close the door of the Lower Freezer Compartment.

5 Touch **Fridge** or **Freezer** button to make an adjustment.

Each time you touch the button, the corresponding indicator lamp changes in the order shown below. Usually it is recommended to use it at the setting of "■■■".

(Lighting Blinking Turned off)

Indication lamp											
Setting	MIN and under	MIN.	→	→	→	MID.	→	→	→	MAX.	MAX and more



To cancel

Follow the operations shown in Step 1, 2, 3 and 4.

2 beeps sound and you can set the temperature by normal step (3 levels).

Locking the Control Panel

Disabling operations can prevent erroneous operations or misuse by children.

When this indicator lamp (Lock of the Control Panel) is illuminated, any other portion of the Control Panel will not be activated by touching it.

1 Touch **MENU** button on the Control Panel to turn on the indicator lamp.

All indicator lamps turn on, and then the current settings are displayed.

2 Press down **Energy Saving** button for 3 seconds or more until the preset sound is heard.

Lock of the Control Panel is changed to "On" or "Off".

The locking of the Control Panel is set to "Off" ("" is unlit) at the time of purchase.

Setting of the Control Panel's lock	"On" (locked)	"Off" (unlocked)
" indicator lamp"	On	Off
Preset sound	Long beep	2 beeps

Notice

- The Auto Door function will not be disabled even when the Control Panel is locked.

In order to stop Auto Door function, unlock the Control Panel, and touch the **Freezer** button for 3 seconds or more until it beeps twice.

→ Pg.50, 51

- When connecting/disconnecting the power plug or after recovering from electric power failure, lock of the panel for operation may be released.

- The indication is turned off after about 40 seconds for energy saving. This setting is maintained until it is released.

Door Alarm

If any door is kept opened for 1 minute or more, it is notified with sound or light.

All the doors have the Door Alarm function. (However, for R-WX670K type, R-WX620K type, no Door Alarm is installed in the Upper Freezer.)

Duration when door is open	1 minute	2 minutes	From 3 minutes onward
Alarm sound	Long beep (3 beeps)	Long beep (5 beeps)	Long beep (continuously), Louder
Display area	Blinking	Blinking	Blinking
For operation	Light ON	Light ON	Light ON

Notice

- While the indicator lamp is blinking on the display area, the Control Panel remains inactive upon touching. Close the door before starting operation.
- Door alarm rings after 30 seconds when the door has been opened only in case the power "Energy Saving" mode set. However the indicator blinks after 1 minute of the opening.

Door Alarm and volume adjustment of the operation sound

You can set the sound level of the alarm louder or no alarm sound.

1 Touch **MENU** button on the Control Panel to turn on the indicator lamp.

2 Press down **Fridge** button for 3 seconds or more until the preset sound is heard.

The volume level of the operation sound is changed from "Standard" to "Louder" or "Sound off". Repeat the change of settings to set the operation sound you like (see the table shown below). The sound is set to "Standard" at the time of purchase.

Volume level	Standard	Louder	Sound off	Standard
Preset sound	—	2 long beeps	Long beep	2 beeps

(At the time of purchase)

Notice

- It is impossible to adjust the volume level of either door alarm or operation sound only.
- When the Door Alarm is disabled, characters on the Control Panel no longer blink.
- Even if the volume level is set to "Sound off", the alarm of the Ice Maker Cleaning is raised and the operation sound is heard when the Auto Door is set to "ON".
- When connecting/disconnecting the power plug or after recovering from electric power failure, it will return to the standard setting where the Door Alarm sounds.

Triple Power Deodorizing Effect

A combination of 3 types of deodorizing materials leads to deodorize various odorous substances in the refrigerator including 4 major odors such as sulfur, nitrogen, aldehyde and oxidization odors. Activities of bacteria collected by the filter are also restricted.

Deodorant filter has the effect of sterile filtration.

- Testing laboratory: Boken Quality Evaluation Institute, a general incorporate foundation
- Test method: Film contacting method (JIS Z 2801)
- Name of the part used for treatment: Filter
- Sterilization method: applying oxidation catalyst to the filter
- Target: bacteria collected by the filter
- Test result: sterilization effect of 99 % after 24 hours by using a filter only. This does not always have effect on the entire refrigerator or foods.

Energy Saving

“eco” Operation indicator lamp

ECO is automatically turned on and inform the energy saving operation when the operation is comparatively stable.

Open or close a door less frequently and quickly. Use this indicator wisely to save energy efficiently.

Notice

If **ECO** isn't illuminated, check the following things.

- Immediately after it is installed, or plentiful foods are stored at a time
- If the door is frequently opened / closed (when the [Door Open & Close indicator lamp] is lit)
- If the door is not closed completely because any food/bag is wedged between the door and the body of the refrigerator.
- “Quick” or “Veg” is set.
- The ambient temperature of the refrigerator is about 35°C or higher.

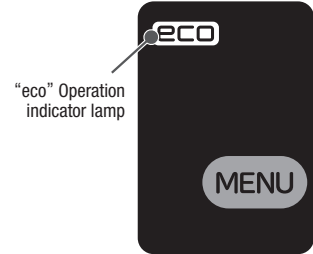

Door Open & Close indicator lamp

When a door is opened or closed frequently, **Door** is automatically lit.

Open or close a door less frequently and quickly. Use this indicator wisely to save energy efficiently.

Notice

- **Door** is turned off automatically after about 5 minutes.
- **ECO** remains unlit when **Door** is lit.

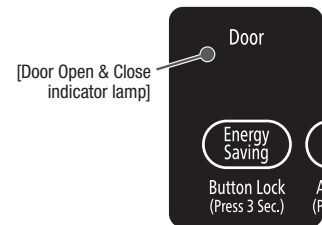

Setting “Energy Saving” mode

Setting the “Energy Saving” mode reduces the ability to cool each compartment for energy savings.

Likewise, when the door of the Vegetable Compartment is left open for 30 seconds or more, the LED light in the compartment has reduced brightness for energy savings.

If a door is not opened or closed for a long time, **the inside is cooled down slowly to further reduce power consumption.**

1

Touch **MENU** button on the Control Panel to turn on the indicator lamp.

All indicator lamps turn on, and then the current settings are displayed.

2

Touch **Energy Saving** button to turn on the “Save” indicator lamp.

The Energy Saving mode is set to “Off” (lamp off) at the time of purchase.

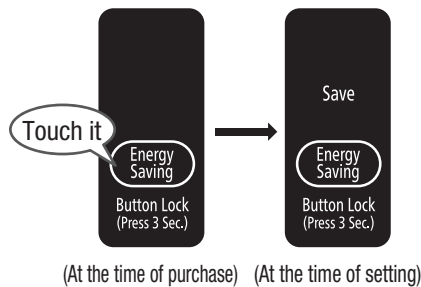

Cancel

Touch **MENU** button on the Control Panel to turn on the indicator lamp, and touch **Energy Saving** button to turn off “Save” indicator lamp.

Notice

- Automatic temperature control lowers cooling loads, which may cause ice cream to get soft and frost to form on frozen food. It also requires longer freezing time and ice making time.
- The “Save” indicator lamp is turned on during the “Energy Saving” mode.
- When “Quick” is set in the Energy Saving mode, the Energy Saving mode is temporarily cancelled, and restored after the completion of the quick operation.
- When both “Save” and “Veg” modes are set concurrently, the cooling function will be weakened from the “Veg”. [→ Pg.60](#)
- When the temperature of the “Freezer Compartment” and/or “Refrigerator Compartment” is set to “■”, the minimum level of cooling is not reduced to maintain the freshness of foods.

ENERGY SAVING

Set the condensation prevention heater to MIN. (Swing partition)

Setting the condensation prevention heater to MIN saves energy.

When dew is formed in the swing partition, set it to the standard.

The temperature settings for the swing partition can be adjusted by three levels (1 to 2), and level 2 is the most energy saving.

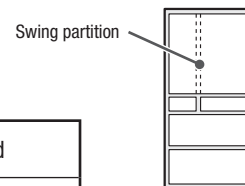

MIN setting of the heater	Standard	MIN setting level 1	MIN setting level 2	Standard
Preset sound	—	Long beep	Long beep (2 beeps)	2 beeps

(At the time of purchase)

1

Open the door of the Lower Freezer Compartment.

2

Touch **MENU** button on the Control Panel to turn on the indicator lamp.

All indicator lamps turn on, and then the current settings are displayed.

3

Press down **Powerful** button for 3 seconds or more until the preset sound is heard.

The setting of MIN level of the dew condensation prevention heater will be switched.

Repeat the above-stated operation to set it to the level you prefer (see the table above).

4

Close the door of the Lower Freezer Compartment.

Notice

- The setting will be returned to the standard when the power plug is disconnected and connected or power failure recovery takes place.

65

MAINTENANCE



Warning

- Make sure to unplug the power plug when maintaining the refrigerator.

When dirt is found

- Wipe off it immediately. It is recommended to clean the hidden places once a year.

Power plug

Once or twice a year

Unplug the power plug and remove dust with a dry cloth.



To prevent fire or electric shock. → Pg.42

Door gaskets

Once a month

Use a soft cloth wet by lukewarm water to wipe off.

Wipe it thoroughly because it can become easily dirty.

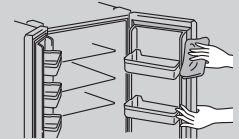

Surface of door

Once a month

Wipe the surface of door using a soft cloth wet by lukewarm water, and then wipe off water with a dry cloth.

Remaining adhesives on glass surfaces, if any, can be removed clearly by using a plastic eraser to rub it and then wiping it off with a dry cloth.

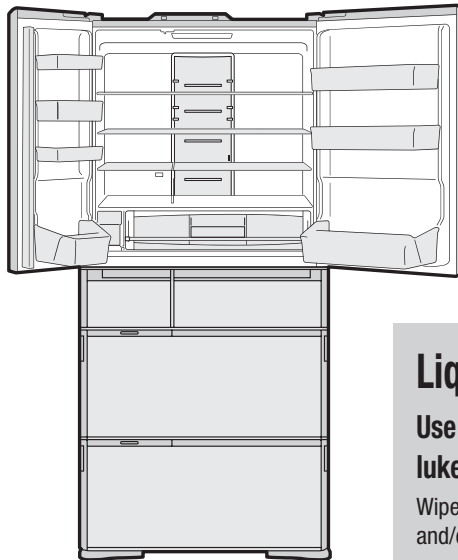

Each shelf/pocket

Once per three months

Use a soft cloth wet by lukewarm water to wipe off.

For how to remove → Pg.70

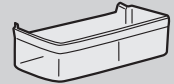

Liquid receivers

Once a month

Use a soft cloth wet by lukewarm water to wipe off.

Wipe off them if liquid collects and/or they become dirty.

Liquid receivers



The back/floor of the refrigerator

Remove the leg covers, raise the adjustable mounts from the floor, pull the refrigerator toward you, and then wipe off dirt.

Once or twice a year

- The back of the refrigerator easily becomes dirty because fine dust is accumulated on it by convection of air. Lay the protection board etc. on the floor which can be easily scratched.
- If you care about vibrating sound, or about discoloration or dirt caused by humidity on a wall behind, install the refrigerator so as to form a gap of 2 cm or more.



Case

Once per three months

Use a soft cloth wet by lukewarm water to wipe off.

When the lower case of the Vegetable Compartment is washed with water, turn it upside down to drain water, and then wipe off water with a dry cloth. Don't use thick-pile toothbrush or scrubbing brush to wash. It may cause damage to case or moisture unit.

For how to remove → Pg.71

※ Do not wash the platinum catalyst with water.

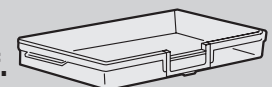

Request

- Do not use the following items because it may cause damage and discoloration of the door, paintwork, plastic parts and glass surface

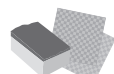

Alkaline glass detergent, Mild alkaline kitchen detergent (other than neutral), Chlorine bleaching agent

Scrubber, Polishing sponge, Chemical wipe

Polishing powder, Washing powder

Benzin, Thinner, Alcohol

Hot water

Check the "Liquid Property field" of your detergent displayed in accordance with Household Goods Quality Labeling Act.

- Make sure to wipe off spilled cooking oil, citrus fruits juice and food soup. Because it may cause damage and discoloration of the door, paint work and plastic parts.
- Do not wipe off lubricant applied to movable contact surfaces of cases and rails for the slide door.
- When a magnet or suction cup is attached on the side surface of the body or the surface of a door, it may leave some mark.
- When unplugging the power plug, the settings of the Control Panel may be released. So check the settings.

Vacuum Compartment Once a month

1 Pull out the Vacuum Case.

For how to remove, (→ Pg.70)

Be sure to remove foods contained in the Vacuum Case.

2 Wipe off following parts with a soft cloth which is steeped in lukewarm water.

※ Do not use the detergents, etc.

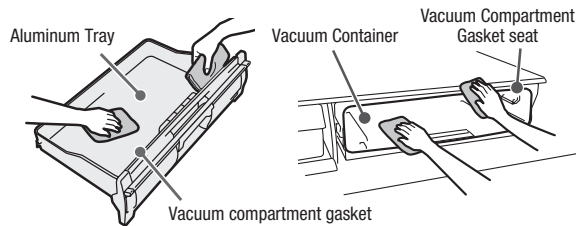

Request

- Wipe the ceiling of the compartment (platinum catalyst and LED light) gently. Failing to do so may cause damage.
- If detergents and others except lukewarm water are used to clean the vacuum compartment gasket, the vacuum compartment gasket may be damaged, deformed or change in color, which may cause the vacuum state unable to keep well.

3 Attach the Vacuum Case.

For how to attach, (→ Pg.70)

Loosened vacuum compartment gasket or loose-fitting door of the Vacuum Case may cause the vacuum state unable to keep well.

When the Vacuum Compartment Gasket is dirt

1 Remove the vacuum compartment gasket from the Vacuum Case.

Grasp the tab of the vacuum compartment gasket on the observer's upper right and remove it by hand carefully.

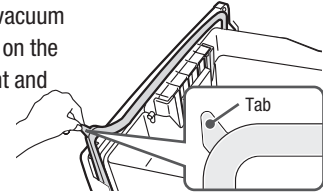

2 Rinse dirty portion in water using a soft sponge, etc.

※ Do not use the detergents, etc.

3 Wipe off excess moisture with a dry cloth and dry it out naturally.

4 Wipe off dirt in the vacuum compartment gasket mounting groove.

Groove for attaching the vacuum compartment gasket.

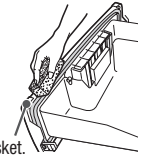

5 Attach the vacuum compartment gasket.

Align the vacuum compartment gasket tab with the notch of the mounting groove.

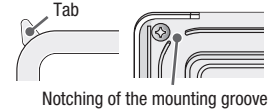

R-ZX740K type
R-WX740K type

Align the indentations of the gasket with the projection (6 locations) of the case and attach firmly.



R-WX670K type
R-WX620K type

Align the hollows of the gasket between the projections (6 locations) of the case and attach firmly.

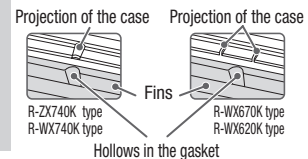

MAINTENANCE

Auto Drawer

Clean the auto door unit when food falls onto or is caught in the upper part of the auto door unit and when liquid is deposited on the auto door unit.

1 Unplug the power plug.

2 Remove each case of the Lower Freezer or the Vegetable Compartment. (→ Pg.71)

3 Remove all foods which drop or are caught in.

4 Wipe off deposited liquid using a soft and dry cloth.

Caution

- Make sure that water never splash to the Auto Drawer unit. Otherwise, it may cause malfunction.
- Do not disassemble the Auto Drawer unit. Otherwise, it may cause injury and/or malfunction.
- Exercise caution not to move the linkage section. Failing to do so may cause a failure.

Warning

- Make sure to disconnect the power plug from the power outlet before starting maintenance to avoid injury.

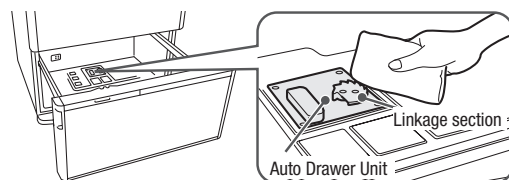

MAINTENANCE (CONTINUED)

Ice Maker Cleaning

When using for the first time

When not used for more than one week



Warning

- Do not place your hand in the mechanical section of the automatic ice maker.
(Rotation of the ice tray may cause injury.)

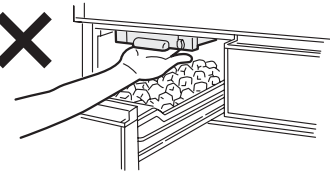

Wash the Ice Tray or water paths with water.

Preparation

Be sure to check the followings before starting the operation.

Water supply container

- Water is filled in it up to the limit line.
- It is set correctly beyond the tank set position line.

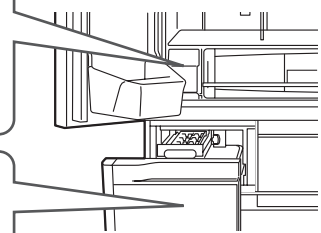

Ice case

- If there remains ice, remove it.

Go to the next step after checking them.

1

Close all the doors.

2

Touch **MENU** button on the Control Panel to turn on the indicator lamp.

All indicator lamps turn on, and then the current settings are displayed.

3

Hold down **Ice Maker** button for 5 seconds or more until the alarm sounds.

When the 3 indicator lamps "Quick", "On" and "Off" start to blink and alarm starts to sound, stop holding the button.

"Ice Maker Cleaning" starts (for about 4 minutes).

- The indicator lamp will flash and the buzzer will sound for about 4 minutes.
- "Ice Maker Cleaning" can't be interrupted.
- If you open any of the refrigerator doors during Ice Maker Cleaning, the cleaning may not work properly. Do not open or close the door until cleaning is completed.
- Door alarm sounds even if alarm is disabled. → Pg.63

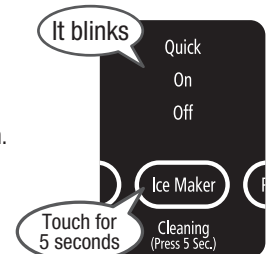

4

Place a clean towel, etc. on the bottom in the Ice Case so that the cutout of the Ice Case can be blocked after the alarm and blinking of the indicator lamp end.

Place a water-absorbing towel on the bottom in the Ice Case to prevent trapped water during the ice maker cleaning from spilling out of the cutout of the Ice Case.

R-ZX740K type, R-WX740K type

R-WX670K type, R-WX620K type

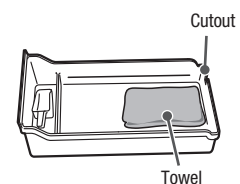
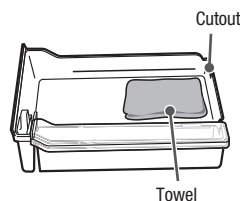

5

Wipe off water inside the Ice Case completely, and then set it to the Ice Compartment.

Remove the towel with which you have wiped off water.

There is no problem with using water remaining in the water supply container, if any.

After "Ice Maker Cleaning", it is set to "On" mode, etc.



Water supply container Once a week

1 Remove the water supply container, and then the lid.

Take up the rear side of the lid toward in the direction of the arrow, and then remove it.

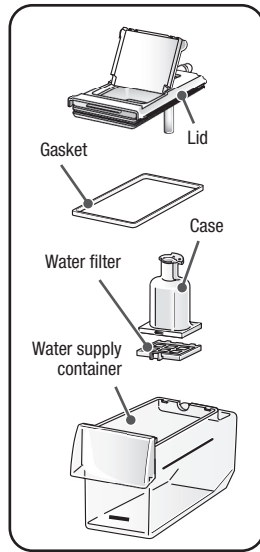
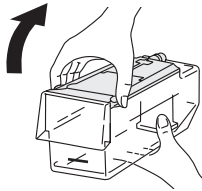

2 Remove the gasket from the lid and then the case.

Turn the case and remove it from the lid.

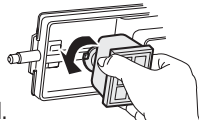

3 Remove the water filter from the case.

Pinch the tab of the water filter with fingers to unset it from the fork, and then remove the case.

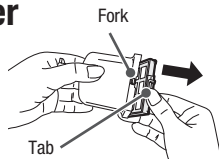

4 Rinse each part of the water supply container in water.

Wash it with a soft wash sponge etc. Do not use the detergents etc.

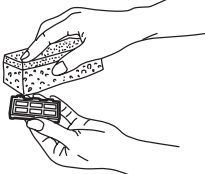

Notice

- Replace the water filter normally every 3 - 4 years.
→ Pg.78

5 Attach each part to the water supply container, pour water in and then set it.

Insert the lid from its rear side and close it in the direction of the arrow.

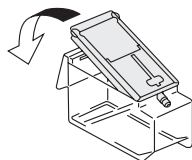

Notice

If you intend not to use the Automatic Ice Maker for an extended period of time, care the water supply tank, dry it adequately, and replace it in a pre-determined position (dry out the water filter, among others).

Ice tray Once or twice a year

1 Touch **MENU** button on the Control Panel to turn on the indicator lamp.

All indicator lamps turn on, and then the current settings are displayed.

2 Touch **Ice Maker** button to turn on "Off" indicator lamp.

It stops water supply to the ice tray.

※ When "Off" indicator lamp blinks, wait for about 1 minute for it to turn on, and then follow the next steps.
Note that the frame cannot be pulled out.

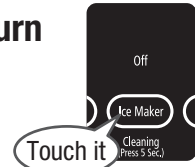

3 Open the door of the Ice Compartment, and take out the ice tray.

- 1 Push the level laterally.
- 2 draw the frame.
- 3 Raise the cover (▲ part) in the direction of the arrow.
- 4 Remove the ice tray from the frame.

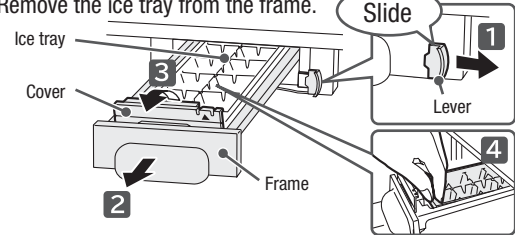

4 Empty the ice tray and wash it lightly in the stream.

Do not use a sponge / cleanser, etc. Be sure not to scarify.



5 Open the Ice Compartment, and then attach the ice tray.

- 1 Set the ice tray
- 2 Hold down the cover to the end until it snaps.
- 3 Push the frame into the rear until the lever slides right.
- 4 Move the frame back and forth to check that it is fixed securely.

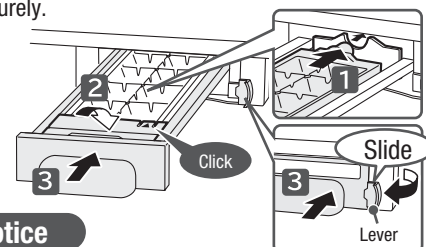

Notice

- If the ice tray frame cannot be pushed into the rear, the motor that drives the ice-tray may have operated since ice-making is not set to "Off". Remove the ice tray and then push the frame alone into the rear, close the Ice Compartment door, touch **Ice Maker** button to enable "Off". After about one minute, the ice-tray driving motor gets ready, allowing you to mount the ice-tray.

6 Touch **MENU** button on the Control Panel to turn on the indicator lamp, and then touch **Ice Maker** button to turn on the "On" indicator lamp. Automatic Ice Making starts.

HOW TO REMOVE/ATTACH PARTS

Caution

- Before removing parts, take out all the foods on the parts.
- Do not remove parts except the ones listed here.
Please contact with a Hitachi customer service centre for cleaning such parts after removing them.
- Do not remove the platinum catalysts in the Vacuum and Vegetable Compartments. Do not wash them with water.

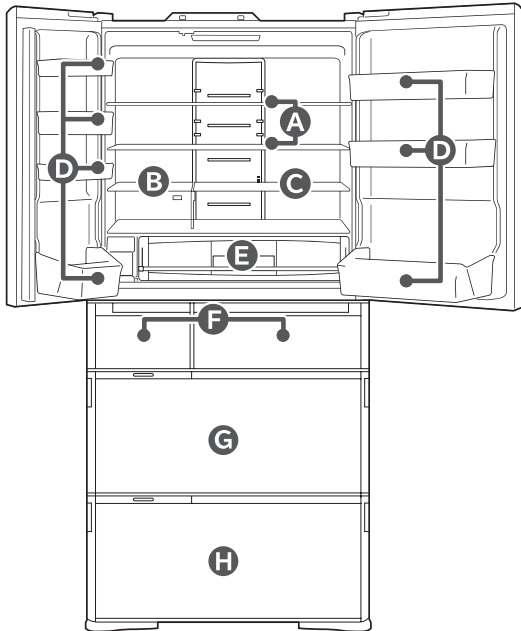

A Height adjustable upper and middle shelf

Request Before removing the upper shelf, remove the middle shelf.

- 1 Slightly lift up the back of the shelf and draw it.**
- 2 Raise the shelf, as shown in the drawing.**
- 3 Rotate and remove it.**

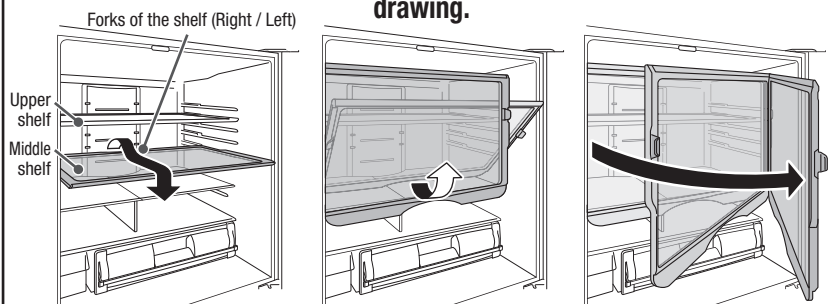

When installing the shelf, slide it until it reaches to the interior wall, then slightly lift up the back of the shelf and push it in.
(hitch the forks of the shelf to the parts on the back of the shelf)

Notice

Be careful to attach/remove the glass shelf because it is heavy. If it drops, it may break and cause bruise or injury.

B Fixed shelf

Draw the shelf, and pull off the 2 pins on the lower right and remove it.

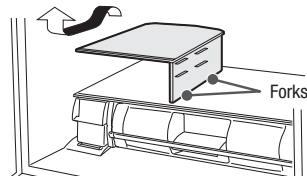

Notice

The shape of the shelves varies by model.

C Height adjustable lower shelf

Slightly lift up and pull out.

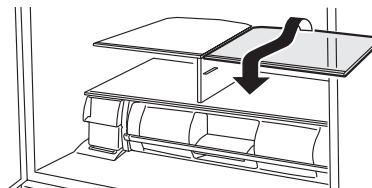

Notice

The shape of the shelves varies by model.

D Door pocket

Lift up the door pocket while tapping the left/right of its bottom surface, and remove it.
(It is fixed a little tightly.)

Caution

Insert the door pocket fully to the end when installing it.
If it drops, it may break and cause bruise or injury.

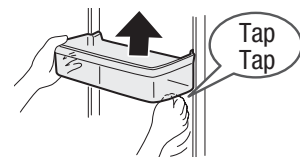

E Vacuum Case

How to remove

Pull out the Vacuum Case by slightly lifting up and moving up and down.

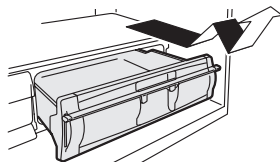

How to attach

Insert the Vacuum Case so that both right and left convex ribs on the case can slide under the guide rail of the Vacuum Container.
Lastly, hold down the handle to lock.

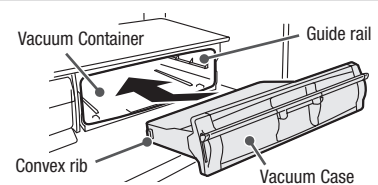

Request

Check that it is fixed properly by taking it in and out a few times.

F Ice Case (Ice Compartment) • Upper Freezer case (Upper Freezer)

Draw the door fully and lift up the case towards you.

Put the case bottom on the frame and set the case.

- Before taking out the Ice Case of R-ZX740K type, R-WX740K type close the lid of the Small Article Case by pulling it to the front.

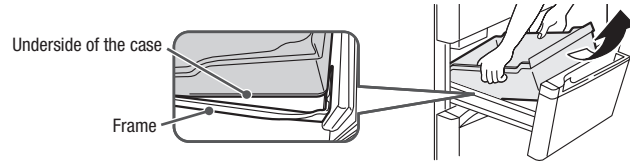

[Only for R-ZX740K type, R-WX740K type]

Remove the lid of the Small Article Case as follows:

(Mount it in the reverse order of removal)

- Slide the lid halfway and deflect the side of the Ice Case to remove the fork.**

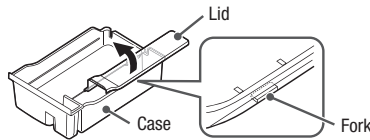

- Slide the lid toward the rear and pull it out.**

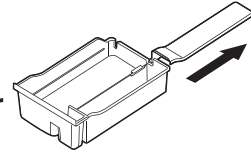

G Slide case and lower freezer case (Lower Freezer)

- Draw the door fully, and draw the Slide case respectively.**

Caution

- Do not remove the Slimline slide case.

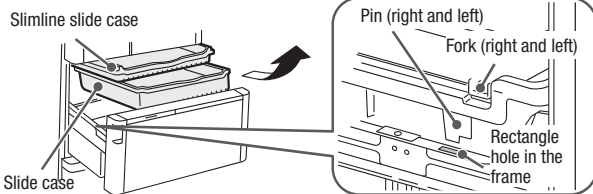

- Lift up the Lower freezer case.**

Caution

- The partition of the Lower Freezer can't be removed.

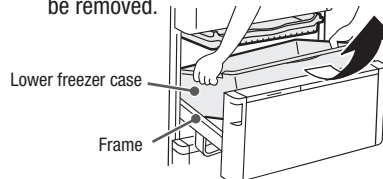

Caution

- Do not peel off the adhesive seal.

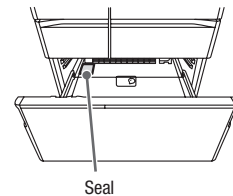

When installing it, insert the pins on the left/right of the Lower freezer case into the square holes on the frame to install it. Moreover, hitch the fork on the left/right of the Slide case to the outside of the Lower freezer case.

H Upper Case, Lower Case (Vegetable Compartment)

- Draw the door fully and pull up both hands further to pull it out slowly and to place it on the floor.**

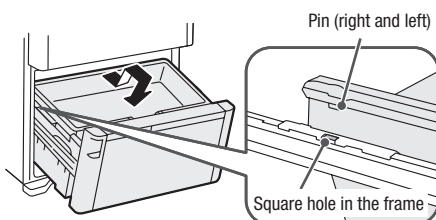

Caution

- When opening the door, do not place your foot near the door. Doing so may get your foot caught between the door and the floor.
- Be careful. Water may drip from the backside of the lower case.

Wrong setting may cause abnormal noise or half-closed door when opening or closing the door.

Request

- The partition cannot be removed.
- Improper installation of the Upper Case may damage parts, including cases. Once the Upper Case is installed, slide it in the front-rear direction to confirm that it is mounted properly.

- Lift up the Upper Case.**

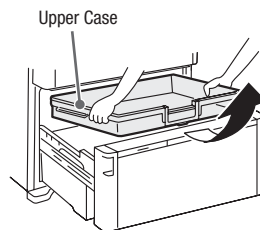

- Lift up the Lower Case.**

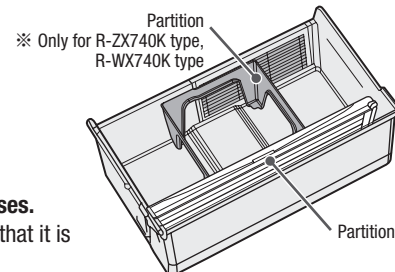
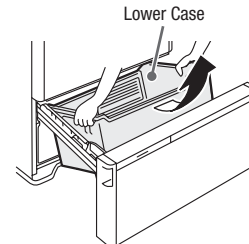

How to attach the slide door (Ice Compartment/Upper Freezer/Lower Freezer/Vegetable Compartment)

Ice Compartment/Upper Freezer

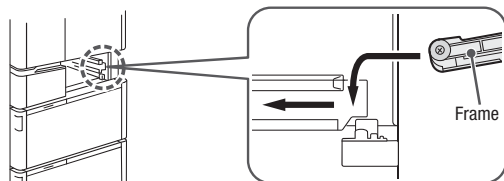



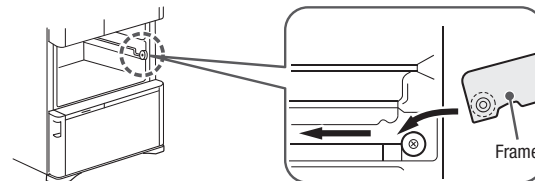





Lower Freezer/Vegetable Compartment

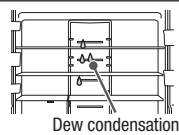
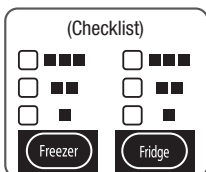



TROUBLESHOOTING

Check the following points before asking repair. Contact your dealer or our customer center if the problem still exists after checking them.

	When this happens	Check Item	Action and Reasons
Initial stage	Not cooled well.	Haven't 24 hours passed since the installation?	Cooling may take more than 24 hours at installation. Place food at appropriate intervals, refrain from opening and closing a door as much as possible and wait. Cooling takes more time during summer or in case of a lot of food being stored.
	No ice is made.	Haven't 24 hours passed since the installation?	As the entire refrigerator is not cooled immediately after installation, it takes more than 24 hours for the first ice to be made. Place food at appropriate intervals, refrain from opening and closing a door as much as possible and wait.
Control Panel	The Control Panel does not respond.	Isn't LOCK lit in the Display Section? If so, the Operation Section is locked.	Cancel the lock of the Control Panel. (→ Pg.62)
		Is Refrigerator Compartment Door open?	Operate after closing it.
		Isn't a water drop or dirt attached to the Control Panel?	Wipe off dirt with a wet cloth and then wipe off moisture with a dry cloth.
		Are you wearing gloves or applying a plaster?	Touch directly with your finger.
	The Operation Section is unlit.	Did you touch adjacent Control Panel wrongly?	Touch the target Control Panel only.
Automatic ice making	Ice cannot be made at all.	Isn't "Off" lit in the Display Section? Ice making is set to Stop Ice Making.	Set it to "On" or "Quick" mode. (→Pg.56, 57)
		Isn't "Water" lit in the Display Section? The water in the water supply tank is low.	Pour water into the water supply container. (→Pg.56, 57)
		Isn't the water in the water supply tank low?	If the water in the tank is low, ice may not be made. Add water until water level reaches to the "Container-full line" of the water supply container. (→ Pg.56)
		Is the water supply container pushed firmly until it is beyond the "Container set position" line?	Push it beyond the "Container set position" line. (→ Pg.56)
		Do you push the frame into the rear until the lever slides right?	Push the frame into the rear until the lever slides right. (→ Pg.69)
		Is anything other than ice stored in the ice case?	Remove it from the Ice Case.
	It takes a long time to make ice.	Is the ice case filled with ice over the limit line of stored ice amount?	Level the ice. (→ Pg.57)
		Do you open the door frequently or store a large amount of food at a time?	The inside is not cooled down enough. Minimize the number of times of opening and closing the door until it cools fully. Allow clearance as much as possible between each stored food.
		Isn't the surrounding temperature low?	Ice making takes more than four hours during winter. Refrain from opening and closing a door as much as possible and wait.
		Haven't you just changed the setting from "Off" to "On"?	Ice-making may take time immediately after changing the setting. Refrain from opening and closing a door as much as possible and wait.
		Does any food or package caught in the door of the Freezer or Ice Compartments prevent the door from closing completely?	Remove caught food, if any, and close the door securely.
		Isn't the "Energy Saving" mode "ON"?	Exit the "Energy Saving" mode. (→ Pg.65)
	Projection is generated on ice.		It is frozen water collected in the ice tray groove. It does not indicate any trouble.
	Stored ice becomes small. Ice sticks together.	Have the ice cubes been sitting in the ice container for a long time?	If ice cubes are left unused, they will gradually grow smaller or stick together. If you can separate the ice cubes by using the ice scoop, this is not an issue.
		Do you open the door frequently or store a large amount of food at a time?	Open/close the door quickly or reduce frequency of opening and closing the door.
		Hasn't a door of the Refrigerator Compartment or a drawer been closed incompletely temporarily?	Close the door completely.
	Small ice is made.	Isn't the water in the water supply tank low?	If the water in the tank is low, ice may not be made. Add water until water level reaches to the "Container-full line" of the water supply container. (→ Pg.56)
	Connected ice is made.	Do you push the frame into the rear until the lever slides right?	Push the frame into the rear until the lever slides right. (→ Pg.69)
		Isn't the Ice Tray damaged?	A damaged Ice Tray precludes the removal of ice cubes from the Ice Tray, resulting in broken ice cubes or ice cubes sticking to each other. Contact your distributor for the replacement of the Ice Tray.
			Water in the groove in the Ice Tray may be frozen and sticks to ice cubes. It does not indicate any trouble.
There is white impurity in ice.	Did you use mineral water to make ice?	It is because the fine air bubble in water is contained in ice. Mineral contained in water may freeze and become white impurity in ice. It may remain after thawing in water, but it is harmless.	
Ice tray frame cannot be drawn.	Is "Off" set?	The ice tray cannot be drawn when the auto ice maker is operating. Set it to "Off". When the "Off" indicator lamp is blinking, wait for 1 minute until "Off" is lit, and then draw the ice tray. (→ Pg.69)	
When you do not make ice		Set "Off". See "Stop Ice Making". (→ Pg.57)	

	When this happens	Check Item	Action and Reasons
Refrigerator does not cool	Is not cooled down. Ice cream is soft.	Does any food or package caught in the door prevent the door from closing completely?	Remove caught food, if any, and close the door securely. Pay attention to the height of food when placing it in the refrigerator.
		Is food squeezed in? or Is a large amount of food put in at one time?	Allow clearance between each food in each compartment.
		Is the case in each compartment fixed securely?	Install them correctly. (→ Pg.71)
		Food cannot be cooled enough, depending on the installation place or surrounding situation.	Check to see if the refrigerator is installed properly. (→ Pg.46)
		Isn't the "Energy Saving" mode "ON"?	Exit the "Energy Saving" mode. (→ Pg.65)
		Isn't the temperature set to "■"?	If a compartment is not be cooled enough, change the temperature setting. (→Pg.52, 59)
		Does the temperature around the refrigerator become high due to weather (ex: in summer)?	
		Haven't you left a door open for a long time or opened or closed it frequently?	Temperature in the refrigerator rises little by little while its door is open. If the door is opened/closed frequently or left open for a long time, temperature cannot easily lower. Reduce the number of times of opening and closing the door, or open/close the door quickly.
Isn't the indication on the Control Panel changing quickly?	The refrigerator is in the demo mode. Please cancel the mode. (→ Refer to the below)		
Frost and/or dew occurs	Frost, dew or ice adheres to the inside of the refrigerator or the frame of the drawer.	Was the door or the drawer not temporarily shut completely?	Check that any food or package caught in the door, and then close it completely.
		Haven't you left a door open for a long time or opened or closed it frequently?	When a door is opened or closed, water in the air may cling to the walls or parts in the Freezer in the form of frost or ice. Open or close the door quickly, or reduce frequency of opening and closing the door. Wipe off the frost or dew with a dry cloth.
	Dew adheres to the outside of the refrigerator.	Is the air surrounding the refrigerator humid?	Dew may adhere to those parts when the indoor humidity is high (ex: rainy day). Wipe off the dew with a dry cloth.
		Isn't the heater for preventing dew condensation set to Low?	When the air surrounding the refrigerator is humid, dew may be formed. Set the heater for preventing dew condensation to Standard. Wipe off the dew with a dry cloth. (→ Pg.65)
		Isn't the temperature set to "■■■■"?	When the temperature is set to "■■■■", dew may be formed on the surface of a door. Set the temperature to "■■■". Wipe off the dew with a dry cloth.
There is condensation on the back of the refrigerator or on the wall.	Is the ambient of the refrigerator humid? Is there sufficient space between the back of the refrigerator and the wall?	Make sure there is at least 2 cm of space between the back of the refrigerator and the wall. (→ Pg.46)	
Dew condensation occurs in the Refrigerator Compartment.	Haven't you left a door open for a long time or opened or closed it frequently?	Condensation may form on the wall and/or around the cold air blowout port when the door is opened and closed frequently or the humidity is high around the refrigerator. No trouble. Wipe it off with a dry cloth. 	
Lamp at Display Section is blinking	3 or more of the temperature adjustment lamps of freezing/refrigerating are blinking.	Check the ON/OFF of 6 lamps of the freezing "■■■■ / ■■■" / "■" and the refrigerating "■■■■ / ■■■ / ■" one by one.	Contact with the customer service with checking <input checked="" type="checkbox"/> to the blinking lamps. If you record, it can be accurately informed. 
	"On"  indicator blinks, or the "■■■■" and "■■■■"  indicators and the "■■■■"  indicator blink	Don't you put food or ice other than that made by the Automatic Ice Maker in the Ice Compartment?	Some foods, etc. may come into contact with the ice tray. Empty the Ice Compartment and do the "Ice Maker Cleaning". (→ Pg.68)
	-1°C blinking	Have you just had your service engineer member inspect your refrigerator?	It may be in the operation check mode for service engineer. It will return to the normal mode after about 15 minutes. There is no problem with using the refrigerator.
	Auto Door blinking	Have you just had your service engineer member inspect your refrigerator?	It may be in the operation check mode for service engineer. It will return to the normal mode after about 10 minutes. There is no problem with using the refrigerator.
	Quick On Off All indicator lamps blink	Haven't your held  for five seconds or more?	It is in process of Ice Maker Cleaning. The blink will stop in about four minutes. Do not open any door of the refrigerator during blinking.
	"Off"  indicator blinking	Haven't you just set "Off"?	The Automatic Ice Maker is working. Blinking stops in about one minute. The frame of the Freezer cannot be removed during blinking.
	All displays blinking	Isn't the door opened? Isn't the door closed incompletely due to food being caught?	Close a door when it is open. If a door is closed incompletely due to food being caught, remove the caught food and close it securely.
	Blinks other than those above	————	Consult your dealer.
	The indication on the Control Panel is changing quickly.	————	The refrigerator is in the demo mode. Please cancel the mode. In the demo mode, the refrigerator does not perform the cooling operation. Open the right and left doors of the Refrigerator Compartment and the door of the Lower Freezer. Touch  on the Control Panel to turn on the indicator lamp. Press and hold the  button for 10 seconds or more until the preset sound is heard. All the indicator lamps are lit for a few seconds, the demo mode is cancelled and the cooling operation is started. Close the right and left doors of the Refrigerator Compartment and the door of the Lower Freezer.

TROUBLESHOOTING (CONTINUED)

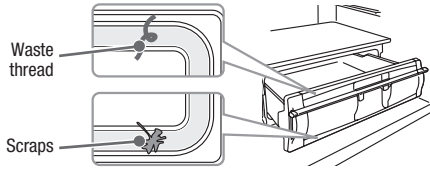
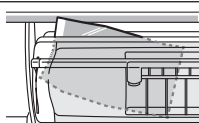
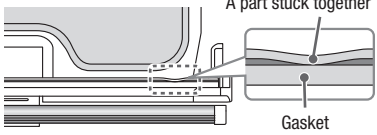
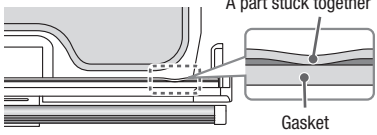
	When this happens	Check Item	Action and Reasons	
Refrigerator cools overly	Refrigerator cools overly. Food freeze.	"■■■■" is selected in the temperature setting.	Switch it to "■■■". (→Pg.52, 59)	
		The surrounding temperature is lower than 5°C.	When the ambient temperature is low, the inside of the refrigerator may cool overly. Switch the temperature setting to "■■■".	
		Is it placed in front of the Cold Air Blowout Port?	Do not place food in front of the cold air blowout port. A lid or plastic wrap can prevent freezing.	
Abnormal operating sound is generated	Annoying sound is generated by the refrigerator.	Does the floor bend?	Install a sturdy board with a thickness of 1 cm and then install the refrigerator. (→ Pg.46)	
		Does the refrigerator come in contact with the wall or furniture, etc.?	Install the refrigerator with clearance around it.	
		Is the refrigerator cooled down enough?	You may feel that the operation sound is loud because the compressor operates in high-speed under the following conditions: the refrigerator does not cool fully on the occasion such as using it for the first time, opening/closing the door frequently, the surrounding temperature is high.	
		Isn't "Spot Cool" / "Quick" set?	When it is set to "Spot Cool" / "Quick", operation sound of the compressor or the fan motor gets louder because of high-speed revolution.	
	Operation sound lasts long.	————	As the compressor operates slowly for energy savings, you may hear an operating noise for a long time.	
	Operation sound sometimes becomes louder.	————	The operating power varies in response to changes in the inside temperature of the refrigerator, and thus you may sometimes hear a large noise.	
	When other sounds such as shown in the right table are generated by the refrigerator.	Sound like water flowing (trickling) Sound like collision (tapping) Sound like water boiling (bubbling up) Sound like meat roasting (sizzling)		These sounds are caused when the refrigerant flows or water flows/ evaporates to remove frost. This is not malfunction.
		Sound like squeaking (cracking) (knocking)		This sound is heard when the parts squeaks due to changes in temperature in the refrigerator or atmospheric pressure in the Vacuum Compartment. This is not malfunction.
		Sound like something is caught (clacking) Sound like roaring (honking) Sound caused immediately after closing the door (booming)		These sounds are caused when the electric parts to control the refrigerator temperature operates. This is not malfunction.
		Sounds caused by the Automatic ice maker (zooming) (rattling) (clunking)		These sounds are made when ice is separated from the ice tray of the auto ice maker or water is supplied to the ice tray. This is not malfunction. To stop the sound, touch the  button to change it to "Off". (→ Pg.57)
Sound occurs sometimes (clacking)			This sound is caused when the refrigerator starts the operation to cool.	
Door is not in a horizontal state	Door is not in a horizontal state.	Is the installation site level?	This does not affect the refrigerator performance. Adjust the refrigerator adjustable mount to keep it level if you want to correct it. (→ Pg.46)	
		Does the soft floor material sink in around the legs due to the weight of stored items?	Lay a firm board which has more than 1cm thickness on the floor if the refrigerator itself inclines.	
Refrigerator becomes hot	The side of the refrigerator becomes hot. Hot air comes from the bottom of the refrigerator.	————	Hot air may come from the bottom of the refrigerator to exhaust the heat generated when the cooling device operates. The temperature may rise to 50 – 60 °C immediately after installation or during summer. It does not pose safety or performance problems, but avoid touching it.	
There is something strange with the Vacuum Compartment	Hissing sound does not occur when opening. 	Is the setting of the Vacuum Compartment to "Off (Non-vacuum)"?	Change the setting to "-1°C (Subzero)" or "+1°C (Chiller)". (→ Pg.55)	
		Is the handle pulled up?	Hold down the handle to lock.	
		Is the handle held down to the end and locked?	The vacuum function will not work unless it is locked. Press the handle until it stops to lock it.	
		Isn't the Vacuum Compartment Gasket removed?	Install the Vacuum Compartment Gasket. (→ Pg.67)	
		Is there anything that is caught stuck to the gasket of the vacuum compartment or its retainer? Is the gasket or its retainer dirty? 	 Remove any packaging material of foods or other things which are caught in. If the gasket is dirty, clean it. (→ Pg.67)	
		Is there any stuck parts on gaskets? 	 If a part of the gasket is stuck together, the vacuum compartment will not be able to maintain a vacuum state. If there is a part stuck together, peel such part off. Since it is difficult to see the left and right side faces and the bottom, such part shall be confirmed with removing the vacuum compartment. (→ Pg.70) If the gasket is dirty, clean it. (→ Pg.67) If it is damaged or deformed, replace it. (→ Pg.78)	
		Was the door of the Vacuum Compartment or the Refrigerator Compartment opened / closed just before?	It takes about three to four minutes for the Vacuum Case to be vacuumed after the vacuum pump starts to operate. Wait for more than four minutes after opening or closing.	

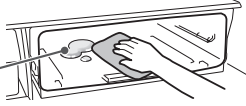
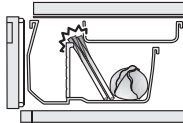
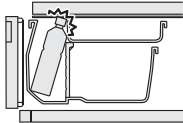
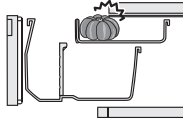
	When this happens	Check Item	Action and Reasons
There is something strange with the Vacuum Compartment	It is not clear whether the Vacuum Compartment has been vacuumized.	Do you hear a sound when opening the Vacuum Compartment?	The Vacuum Compartment has been vacuumized properly if a vacuum releasing sound (hissing sound) is heard when opening it.
	The handle cannot be locked.	Is there any food etc. caught in the inner part of the Vacuum Compartment Case or the vacuum compartment gasket?	Remove any food if it is caught in.
		Is the Vacuum Case set in place?	Mount the Vacuum Case as shown in "How to attach the Vacuum Case". (→ Pg.70)
	Booming sound and vibration occur around the Vacuum Compartment.	_____	This sound is caused when the vacuum pump operates. You can stop the vacuum pump operation when you want to stop the sound (ex: night time). Change the setting of the Vacuum Compartment to "Off (Vacuum off)" (Non-vacuum). (→ Pg.55)
		Isn't something caught in the Vacuum Case or the gasket of the Vacuum Compartment dirty? Do you push down the handle until it stops to lock it?	A sound may be heard or vibration may be felt more frequently. Remove any packaging material of foods or other things which are caught in. Clean the vacuum compartment gasket if it is dirty. (→ Pg.67) Push down the handle until it stops to lock it.
	Dew, frost or ice is formed inside the Vacuum Compartment or around the Vacuum Case.	Don't you place food containing a lot of water? Dew and/or frost 	The moisture from the juicy food may cause dew condensation and/or frost adhering insider the compartment because the Vacuum Compartment is sealed. It is recommended to wrap the juicy food with plastic film, etc. Wipe dew and /or frost off with a soft cloth wet by lukewarm water.
Food in the Vacuum Compartment freezes.	Is the Vacuum Compartment set to "-1°C (Subzero)" or "Off (Vacuum off)" (Non-vacuum)?	Set the "+1°C (Chiller)". (→ Pg.55)	
It smells strange	Plastic smells	_____	This smell occurs because a lot of plastic parts are used in the refrigerator, but the smell decreases gradually while cooling. This is not malfunction.
	Ice smells	Do the water supply container and/or water filter become dirty? Or does ice become old?	Wash them regularly to prevent "slime" and/or "fur". (→ Pg.69)
		_____	Chlorine may strongly smell because chlorine in tap water is condensed.
It smells in the refrigerator	Is any food which strongly smells stored without any wrapping?	The deodorizing function cannot completely remove all smells. Seal that kind of food with plastic film etc.	
Vegetable Compartment	Dew condensation occurs in the Vegetable Compartment.	Don't you place a large amount of vegetable containing much water?	As the Vegetable Compartment is more humid than the other compartments, dew may be condensed in the case or ceiling of the Vegetable Compartment or on the surface of food, depending on the amount or type of vegetable stored there. This is not abnormal state. To avoid dew condensation, wrap a vegetable with plastic food wrap before storing it in the Vegetable Compartment. Heavy dew condensation may cause water to be pooled in the Vegetable Compartment. Wipe it off with a soft cloth.
		Isn't the Moisture Unit blocked with food bags or containers?	A blocked Moisture Unit is likely to cause dew condensation. Move the food bags or containers that block the Moisture Unit to other portions. Wipe off the dew condensation with a soft cloth.
	The Vegetable Compartment door doesn't close / When the Vegetable Compartment door is opened, the upper case doesn't go back to the locking position.	Is any food, etc. caught between the upper case and the lower case? 	Remove it if any.
		Isn't a plastic bottle and/or food item in contact with the handle of the Upper Case? 	Store PET bottle, food, etc. so that they don't come in contact with the locking handle.
		Isn't food caught between the Upper Case and Moisture Cover? 	Remove it, if any. Do not close the door with force while the food is in contact with the Moisture Cover.



TROUBLESHOOTING

TROUBLESHOOTING (CONTINUED)

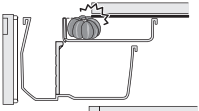
	When this happens	Check Item	Action and Reasons
Auto Refrigerator Door	Noise is loud. There is an abnormal noise.	Hitting sound (thumping sound)	This is the operating sound of the Auto Refrigerator Door. This is not malfunction.
		Buzzing sound (whir)	This is the operating sound of the Auto Refrigerator Door. This is not malfunction.
		Operation sound in the Vegetable Compartment is heard louder than it at the Lower Freezer.	Operation sound in the Vegetable Compartment is heard louder than it at the Lower Freezer. And it varies depending on the quantity of the stored food. This is not malfunction.
	Auto Door won't open even if touching the Open Button.	Is the Auto Door light not lit? Turn on the light.	Turn on the Auto Door indicator lamp. (→ Pg.50)
		Isn't the Ice Compartment or the Upper Freezer opened?	Close the slide door and then touch the Control Panel of the Auto Door.
	The Auto Refrigerator Door does not close.	Is any food or food bag caught on the compartment?	Remove foods and others that are caught in.
		Did a power failure occur or did the compartment knock against any obstacle during electrical operation?	Auto Refrigerator Door stops on the way, so push in the door with hand.
	Auto Refrigerator Door does not open widely.	Don't stored beverages or foods make contact with the wall in the Refrigerator Compartment?	Remove beverages or foods that make contact with the wall.
		Is the installation site level?	Opening angle of the Auto Refrigerator Door may vary or the door may go back a little after it is opened automatically depending on installation conditions of the refrigerator, but this is not malfunction.
	Auto Refrigerator Door moves even if it is locked on the Control Panel.		Auto Refrigerator Door can not be locked from the Control Panel. In order to stop Auto Refrigerator Door, unlock the Control Panel first, and then touch Freezer button for 3 seconds or more until it beeps twice. (→Pg.50, 62)
Auto Drawer	Noise is loud. There is an abnormal noise.	Hitting sound (thumping sound)	This is the operating sound of the Auto Drawer. This is not malfunction.
		Buzzing sound (whirring, grunt)	This is the operating sound of the Auto Drawer. This is not malfunction.
		Operation sound of the Vegetable Compartment is louder than that of the Lower Freezer.	Operation sound of the "vegetable compartment" is louder than the "lower freezer". The operation sound depends on the amount of food stored. This is not malfunction.
	The compartment does not open even if the electrical drawer switch is pressed.	Is the Auto Door light not lit? Turn on the light.	Turn on the Auto Door indicator lamp. (→ Pg.50)
		Is either one of the lower freezer or the vegetable compartment open?	Close the open electrical drawer compartment and then press drawer switch for the compartment you want to open.
	The Auto Drawer does not open/close.	Is any food, food bag or plastic wrap, etc. caught on the compartment?	Remove foods and others that are caught in.
		Did a power failure occur or did the compartment knock against any obstacle during electrical operation?	The door does not open/close smoothly because the electrical drawer function is stopped before the operation completes. Manually push in the door with strength. Otherwise, unplug the power plug with the door drawn, and connect it after 10 seconds.
		Isn't the food caught between the Upper Case and the Moisture Cover? 	Remove it, if any. Do not close the door with force while the food is in contact with the Moisture Cover.
	The Auto Drawer does not open much.		The Auto Drawer is pulled out by approx. 15 cm or more. The length may vary depending on installation conditions of the refrigerator, or the Auto Drawer may go back a little after the door is opened automatically. This is not malfunction.
	Auto Drawer moves even if it is locked on the panel for operation.		Auto Door can not be locked from the panel for operation. In order to stop Auto Door function, unlock it first on the panel for operation, and then touch Freezer button for 3 seconds or more until it beeps. (→Pg.50, 62)

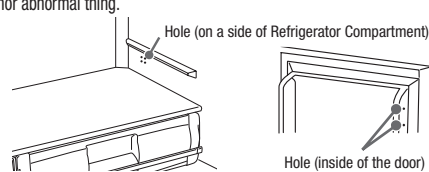

	When this happens	Check Item	Action and Reasons
Others	You feel electricity a little when touching the main body of the refrigerator.	_____	The refrigerator may be charged with static electricity, but there is no problem with the safety.
	Radio and/or television are disturbed by noises.	_____	It is caused by the electromagnetic radiation slightly generated from this refrigerator. Install the refrigerator away from the television, radio and interphone. It is recommended to connect the power plug to the power outlet separated from the antenna terminal.
	There are thin lines like scratches on the plastic parts.	_____	Those lines are caused by the liquid resin flowing when plastic is molded. They are especially conspicuous for the transparent parts, but there is no problem with the strength and they can never lead to any cracks.
	There are waving and/or distortions on the door surface, the side and the top surface of the refrigerator.	_____	Slight waving and/or distortions are generated in the manufacturing process of the refrigerator. They may be conspicuous according to the position of the light source and/or the brightness etc., which is not malfunction. There is no problem with the performance.
	There is a small hole inside the door.	_____	This hole is used to escape the air inside when filling the heat insulation material into the door during the production process. It is neither a flaw nor abnormal thing.  <p>Hole (on a side of Refrigerator Compartment)</p> <p>Hole (inside of the door)</p> <p>* Some products have an adhesive seal to conceal the hole. Please do not peel it off.</p>
	The electric supply failed.	_____	Reduce the number of times of opening and closing the door and avoid storing food additionally until the electric supply is restored. Please check each setting on the panel for operation after the power comes back on.
	The refrigerator is not expected to use for a long term.	_____	Remove all the items in the refrigerator. Unplug the refrigerator to take care of the inside or the automatic ice maker. (→Pg.66-69) Leave all the doors open to dry the refrigerator for 2 or 3 days.
	Remove frost.	_____	Any operation to remove frost is not required because this refrigerator remove frost automatically. Thawed water is collected in the evaporating tray and automatically evaporates.
	Transporting and moving care.	_____	See "Transporting your refrigerator (transport for moving)" (→ Pg.78)
	Glass is broken (door glass, glass shelf)	_____	Do not touch a broken glass, but contact your dealer for repair soon.
	When a door is shut, another is naturally opened.	_____	Did you shut the door too strongly? Compartments are connected each other by cool air paths therefore the wind pressure caused by shutting a door may open another door for just a moment.
	A door is heavy to open just after shutting it.	_____	Have you leave the door open long time? It is because that the air taken inside is cooled and its pressure reduces temporarily. Don't leave a door open long time. Open and shut it at each time.
	Bothered by vibration noise, discoloration and dirt on the back wall due to moisture.	_____	Keep it away from the back wall (2 cm or more). (→ Pg.46)
When a midge fly, etc. enters in the refrigerator	Are there fruit flies around it?	_____	Keep the environment clean. Put something a fruit fly hates or fruit fly traps or something like that.
	Is there any food with strong flavor in the refrigerator?	_____	Cover food with the lid so that fruit flies can't be attracted by the flavor.
	Is the door left open for a long time?	_____	Please close the door as soon as possible.

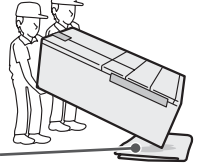
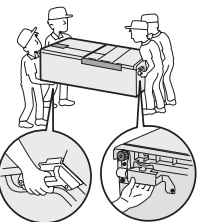
Transporting your refrigerator (transport for moving)

- | | | | | |
|---|---|---|---|---|
| 1 | Take out foods or ice. | 7 | Place a sheet or cloth for protection first, and then lay it back to drain water.
<small>Such as old cloth</small> |  |
| 2 | Empty the water from the water supply container/ice tray. | | | |
| 3 | Pull off the power plug.
<small>No problem just before moving.</small> | 8 | Make sure to hold the handles when carrying it with 2 persons or more.
<small>Do not lay it down horizontally for transportation (which may cause failure of the refrigerator).</small> |  |
| 4 | Remove the leg covers, and raise the adjustable mounts. → Pg.46 | | | |
| 5 | Use a tape to secure the door/power cord. | 9 | See “Preparation before use” for installing the refrigerator in a new location. → Pg.46, 47 | |
| 6 | Place a sheet or cloth for protection when moving / transporting it.
<small>To prevent damage to the floor material or water from spilling out.</small> | | | |

AVAILABLE PARTS

■ If you order any part listed below, specify the model of your refrigerator to a dealer for purchasing genuine parts.

Subject	Product Name	Model	Product Model	
Ice smells ● Water filter may be old and dirty (available about 3 or 4 years, as a guide)	Water filter for the automatic ice maker	Common for all models	RJK-30	
Vacuum state can't be maintained ● It may be damaged, deformed or discolored.	Vacuum compartment gasket	R-ZX740K type	R-WX7400G 311	
		R-WX740K type		
		R-WX670K type		
		R-WX620K type	R-XG6200G 311	

有關碳氫化合物的冰箱 / 可容納的食品重量

ABOUT NON-CFC REFRIGERATORS/STORABLE WEIGHT



有關碳氫化合物的冰箱 About non-CFC refrigerators

- 本冰箱所使用冷媒及其他斷熱材料皆無使用氟氯化碳 而是使用碳氫化合物。碳氫化合物不會破壞地球臭氧層、對地球溫室效應的影響非常小、屬於環保物質。
- 碳氫化合物為可燃型物質。冷媒密封於冷媒迴路管中、在一般的使用情況下應該不會發生外洩。但萬一有冷媒管線損壞的情況發生、請遠離火源及避免使用電器用品、將門窗打開以利空氣流通。之後、請立即與經銷商或日立技術中心聯絡。
- Instead of CFCs, hydrocarbons are used in the coolants and insulation materials used in this refrigerator. Hydrocarbons do not damage the ozone layer, and they are environmental-friendly materials, having an exceptionally small affect on global warming.
- Hydrocarbons are flammable. The coolants are sealed in the coolant circuitry, and with normal operation they will not leak, but should the circuitry be damaged, refrain from using flames or other electrical products, and open windows for ventilation. After that, please contact the dealer or Hitachi customer service centre.

可容納的食品重量 Storable weight

可容納於層架或收納盒內的食物重量如下：

The following table shows the weight of food that can be stored on the shelves and in the cases.

	零件名稱 Name of parts	R-ZX740K 型號 R-ZX740K Type R-WX740K 型號 R-WX740K Type	R-WX670K 型號 R-WX670K Type	R-WX620K 型號 R-WX620K Type
冷藏室 Refrigerator compartment	可調式層架上段 Height adjustable upper shelf	23.0kg	21.0kg	19.5kg
	可調式層架中段 Height adjustable middle shelf	23.0kg	21.0kg	19.5kg
	可調式層架下段, 固定層架 Height adjustable lower shelf, Fixed shelf	23.0kg	21.0kg	18.5kg
	真空冰溫室上方的層架 Upper shelf of the vacuum compartment	12.0kg	11.0kg	10.0kg
	真空冰溫室盒 Vacuum compartment case	5.5kg	5.0kg	4.5kg
	冰箱門置物架 (右側) 合計 Total for the right door pockets	26.0kg	26.0kg	20.0kg
冰箱門置物架 (左側) 合計 Total for the left door pockets	14.5kg	11.0kg	11.0kg	
製冰室 Ice compartment	製冰盒  19頁 Ice case  Pg.57			
	小物品收納空間 Small Article Case	1.0kg	—	—
上層冷凍室 Upper freezer	上層冷凍盒 Upper Freezer case	9.0kg	9.0kg	8.0kg
下層冷凍室 Lower freezer	上層滑動盒 Slimline slide case	6.0kg	5.5kg	5.3kg
	中層滑動盒 Slide case	8.0kg	7.0kg	6.5kg
	下層冷凍盒 Lower freezer case	19.0kg	17.0kg	15.5kg
蔬果保鮮室 Vegetable compartment	上層滑動盒 Upper Case	8.5kg	7.5kg	7.0kg
	下層置物盒 Lower Case	24.0kg	22.0kg	18.0kg

關於廢棄之重要警告 Severe warning signs for Disposal

隔熱材料中含有環戊烷 (Cyclopentane)。

當要處理隔熱材料中之氣體時，必須依照特殊的廢棄處理程序。

要廢棄本產品時，為了不會對環境造成不良影響，請詢問當地的相關機關。

Cyclopentane is used in the insulation material.

The gases in insulation material require a special disposal procedure.

Please contact your local authorities in regard to the environmentally safe disposal of this product.

AFTER-SALES SERVICE

關於售後服務

Please contact the following Hitachi Service Centre if power cord is damaged or service is required.
If some malfunction occurs during operation, unplug the power plug immediately and contact the service centre to have the refrigerator repaired.

電源線受損或需要維修時，請直接洽詢下列日立服務中心。
使用中出現異常現象時，請立即拔掉電源插頭以及聯絡售後服務中心以進行修理。

- Australia
Hitachi Australia Pty. Ltd.
Locked Bag 2052, North Ryde, NSW 1670, Australia
Suite 801, Level 8, 123 Epping Road, North Ryde, NSW,
2113, Australia
Tel : +1-800-448-2244
- Malaysia
Arcelik Hitachi Home Appliances Sales Malaysia Sdn. Bhd.
Lot 12, Jalan Kemajuan, Bangi Industrial Estate,
43650 Bandar Baru Bangi,
Selangor Darul Ehsan, Malaysia
Tel : +60-3-8926-4168
Fax : +60-3-8926-3013



R-ZX740K 型號 R-ZX740K Type ©
R-WX740K 型號 R-WX740K Type
R-WX670K 型號 R-WX670K Type
R-WX620K 型號 R-WX620K Type