

Instruction Manual

Refrigerator

No Frost

Model

R-S700PND0

R-S800PB0

R-S700PMS0

R-S800PM0

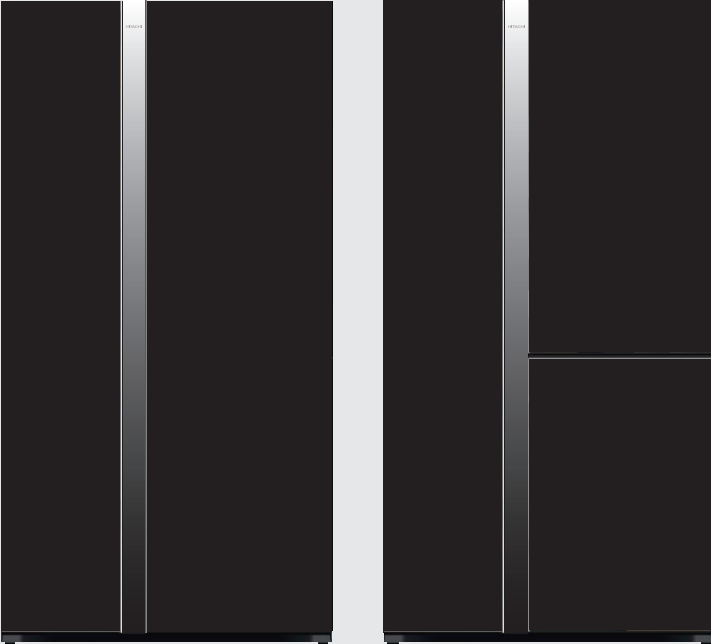

Thank you very much for purchasing the HITACHI refrigerator.

Before using this please read the instruction manual carefully for the correct usage.

Maintenance work must only be carried out at workshop
by well-trained maintenance worker



Refrigerator Installation
(English Version)

HITACHI

Contents

Preparation for Use

Warnings and Cautions for Safety	2
Preparations before Use	5
■ Installation	5
■ Before Use	6
■ Optimal Food Storage	6

Operation

Location of Food Storage	7
How to use Control panel	8
■ Name and fuction of The Control Panel	8
■ Temperature control	8
Freezer Compartment	10
Refrigerator Compartment	12
Vegetable Compartment	13

Maintenance and Troubleshooting

Maintenance (General Matter)	14
Parts Removal	15
■ How to remove parts	15
Troubleshooting	16
■ General Problems	16
■ Dew or Frost is generated	18
■ Service center	19

For household use only

R600a



Refrigerant



Warnings and Cautions for Safety

To avoid harm to the user, other persons or damage to property, please read and follow the warnings and cautions below and those given throughout this manual.

The following warnings and cautions are categorized by the level of possible harm or damage that may occur from ignoring directions.

The symbols are shown as below clearly showing the significance of directions.

	Warning	This pictograph indicates "There is high possibility of serious injury or death, if ignored".
	Caution	This pictograph indicates "There is a high possibility of injury or damage to property if ignored".

The symbols below are examples.	
	This symbol is an alert mark.
	This symbol indicates "prohibited".
	This symbol indicates "necessary".



■ This refrigerator uses flammable refrigerants. The symbol column below states the precautions on flammable refrigerants.



This symbol denotes the precautions on flammable refrigerants.

WARNING

When you install ... To avoid fire, electric shock, and injury.

-  ■ Do not install the refrigerator in a place where it may come in contact with water.
-  ■ Do not install the refrigerator in a place exposed to rain.
 - This may impair electricity insulation and cause electric shock or fire.



- Ground this refrigerator to prevent electric shock and noise interference. Always ground this refrigerator and install earth leakage circuit breaker when using it in please with high humidity or moisture. (Please consult with a retailer or Hitachi Service Center.)

Power Cord and Power Plug ...To avoid fire, electric shock.

-  ■ Do not connect the wall outlet whose power capacity is less than the refrigerator's. Also, do not use power sources that are not a rated voltage.
 - If a power source is shared with other appliances using double or multipoint adapters, the adapter
 - Do not locate multiple portable socket-outlets or portable power supplies at the rear of the appliance.

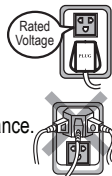

- Connect the power plug firmly to a power outlet with the cord running down.
 - Connection of the power plug with the cord running up could apply stress on the cord and cause electrical short or overheat, which could result in electrical shock or fire.
 - Incomplete connection of the power plug could result in electrical shock or fire due to heat.



-  ■ Do not use a damaged or loose power plug or power outlet. This may cause fire or electric shock.



- If the supply cord is damaged, it must be replaced by the manufacturer, its service agent or similarly qualified persons in order to avoid a hazard.



-  ■ Do not cut, bend, fold the power cord to avoid fire and electric shock.



- Clean the dust on the power plug frequently with a dry cloth.
 - Unplug the power plug and wipe it with a dry cloth.
 - An insulation failure due to moisture, when dust collects on the power plug, may cause fire.



-  ■ Do not insert or remove the power plug with wet hands.



- Be sure to unplug the power plug before maintaining the refrigerator.
 - Be sure to hold the power plug to unplug.



During daily use ...To avoid fire, electric shock.

-  ■ Do not splash water on or inside the refrigerator.
 - This may impair electricity insulation causing electric shock or fire.
 - This may also cause the gas leakage because of pipe rust.



- Do not put water containers or foreign articles on the top of the refrigerator.
 - Opening and closing doors etc. may cause the articles on the top of the refrigerator may fall down, resulting in injury.



-  ■ Do not disassemble, repair, or modify your refrigerator by yourselves.
 - Please consult with a retailer if any repair is required.



- Do not use the refrigerator in the atmosphere of flammable gas.
 - Sparks from points of electrical contacts such as door switches may ignite a fire.



-  ■ Do not use other electrical appliances in the food storage compartment, unless it is the type recommended by the manufacturer.

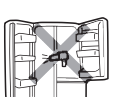

- Do not use mechanical devices or other means to accelerate the defrosting process, other than those recommended by the manufacturer.



! WARNING

- Do not damage the refrigerant circuit.



- Keep ventilation openings in the appliance enclosure or in the built-in structure, clear of obstruction.

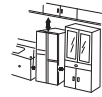

During daily use ...To avoid fire, electric shock.

- This appliance is not intended for use by persons (including children) with reduced physical, sensory or mental capabilities, lack of experience and knowledge, unless they have been given supervision or instructions concerning use of the appliance by a person responsible for their safety.

- Children should be supervised to ensure that they do not play with the appliance.
 - Children getting inside may not be able to get out.
 - Cleaning and user maintenance shall not be made by children without supervisor.



- Do not hang on the doors or step up on the various compartments.
 - Injury may be caused by the refrigerator tipping over or hands getting caught in door.



- Ether, liquid propane gas, solvent, aerosol cans, etc. which is volatile cannot be stored in this refrigerator.
 - Do not store anything that are generate heat or fire spark inside the refrigerator.



- Medicines, chemicals, research and experimental substances should not be stored in the refrigerator.
 - Substances that require precise conditions for storage cannot be stored in a domestic refrigerator.



- In the event of a flammable gas leak, do not touch the refrigerator and open windows to ventilation.



- If you find something wrong with the refrigerator, immediately unplug and consult with the retailers.



- Do not make an impact on the glass-made doors or shelves.
 - They are made of tempered glass; however, an excess impact may result in breakage, and is dangerous.



- When replacing the refrigerator interior lamp, unplug the power cord. Use the specified lamp and fix it firmly when replacing.



- Do not damage the refrigerant circuit.
 - If you happen to damage the refrigerant tube, stay away from the refrigerator and avoid using fire and electrical appliances.
 - Open the window to ventilate and contact retailers or service center.

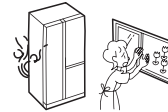

- This appliance is intended to be used in household and similar applications such as
 - Staff kitchen areas in shops, offices and other working environments;
 - Farm houses and by clients in hotels, motels and other residential type environments;
 - Bed and breakfast type environments;
 - Catering and similar non-retail applications.
- When positioning the appliance, ensure the supply cord is not trapped or damaged.
- Do not locate multiple portable socket-outlets or portable power supplies at the rear of the appliance.

When discarding the refrigerator

- Follow the instructions of your region when discarding.
 - This refrigerator uses R-600a for the refrigerant and cyclopentane for the blowing agent of the urethane heat insulation.

- When discarding the refrigerator, remove the door gaskets.
 - To avoid a risk of an infant or child to be entrapped inside.



CAUTION

During daily use ...To avoid illness and injury.



- Do not put bottles, etc. forcibly in the door pockets.
 - This may cause bottles dropping down or door pockets coming off.



- Do not have food items protruding over the front edge of each shelf.
 - Doors may not be closed properly or the door pockets may drop down. Injury may be caused from items like bottles falling and knocking over your feet.



- Do not store food which smells or food whose color is changed abnormal.
 - Such an action may cause diseases.



- Do not store glass bottles in the freezer compartment.
 - Bottles may break by the contents freezing and cause injury.

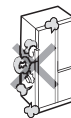

- Food and containers inside the freezer compartment should not be touched with wet hands.
 - This may cause frost injury. (Especially in case of metal items.)



- Do not put your hands into the bottom surface of the refrigerator cabinet.
 - When cleaning, putting your hands near the bottom surface of the refrigerator may result in injury by thin metal sheets.



- Do not hold the top, bottom and side of the doors when closing them.
 - This may result in your fingers caught by the door edge.



- Be sure to hold the handle firmly to open and close the door.

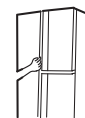

- If someone else is using the refrigerator, do not open or operate the control panel.
 - Fingers may get caught in the spaces between the doors and may cause injury.



- Do not have your feet too close when opening the door of the refrigerator.
 - When opening the door, your feet may be hit, resulting in injury.



When moving or carrying ...To avoid damaging, wetting, soiling the floor or to avoid injury.



- Do not use door handles when carrying the refrigerator.
- Never use the carrying handles to hang up with a chain hoist or similar machines.



- On a floor that is easily scratched do move the refrigerator using the wheels at its base.
 - The wheels may scratch the floor.
 - For a floor that may be easily scratched, lay a protective mat, etc. .



- Use the carrying handle when carrying the refrigerator.
 - Hold the carrying handles only. If you hold door handles, your hands may slip and may cause injury.
 - More than 4 persons should carry the refrigerator for safety reasons.
 - Carry it with the doors facing upward.
- Before carrying the refrigerator:
 - Take out the food items and ice cubes.
 - Dispose of the water in the evaporating tray located in the bottom of the refrigerator.
 - Place the protective mat or cloth on the floor on which you move.
 - Finally carry the refrigerator with the doors facing upward.
- Secure the doors well with adhesive tapes so they do not open.
- If transporting in a vehicle, do not load the refrigerator on its side. This could damage the compressor.

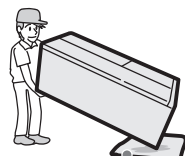

Such as old cloth

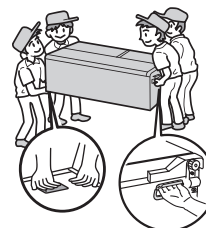

Preparations before Use

1

Installation

1. Check the width of the doors of the house.

- Following shows the installation dimensions for this refrigerator. Be sure to check if you with refrigerator can pass the house doors.
- The refrigerator doors may have to be removed if the width or depth of the refrigerator are more than the width of the house doors.
- To remove the refrigerator door, please consult with the retailer.

2. Install the refrigerator in the following place.

- Install on a rigid and level floor.
 - If you install on a such a floor, place a wood board (1 cm thick) and place the refrigerator on the board.
 - In case that the floor may be deformed or floor color may be changed due to a heat from the refrigerator.
 - In case of soft or fragile floors on which the refrigerator might incline.
 - Do not install where the refrigerator is exposed on a direct sunlight or other heat sources.
 - Such circumstances may result in poor cooling performance or electricity costs increase.
 - Direct sunlight will cause discoloration of the plastic parts of the refrigerator.
 - Install in a atmosphere which is dry or has air ventilation.
 - This helps to avoid rusting and keeps electricity costs down.
- * If you wish to install the refrigerator in a hot spring area exposed to sulfide gas, you may need to apply anti-rust treatment to the piping. Contact your dealer in advance. A failure caused by that gas damage will not be covered under guarantee.

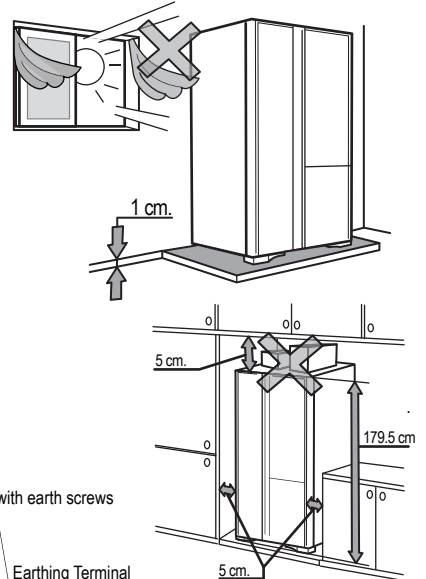

3. Allow enough space to release heat.

- The refrigerator requires enough air ventilation space around the cabinet to have efficient cooling performance.
 - At least 5 cm space must be secured for the left/right, top and back side of the refrigerator to the wall.
- To ensure that the doors can open properly and fully, make sure that the following space is available.
Please check the available space before installation

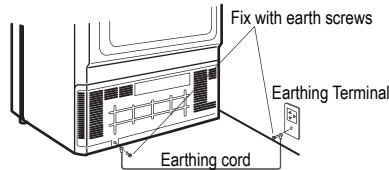

4. Earthing wiring.

- Ground this refrigerator to prevent electric shock and noise interference. Always ground this refrigerator when using it in places with high humidity or moisture. (Please consult with retailers.)

when opening the doors, please open carefully until it stop approximate at 130°
Do not over open. Otherwise the door may cause damage.

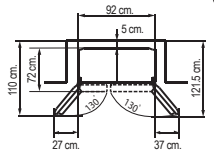

WARNING

Do not connect the ground line to a gas pipe, telephone line or lightning rod.

5. Adjusting the adjustable legs to keep the left/right refrigerator door level.

- Without adjusting the legs, door height may not be level, or there may be abnormal vibration or noises depending on floor conditions. Follow the instructions below.

- ① Turn the adjustable legs to lower the adjustable legs until they touch the floor firmly.
 - ② Compare the height of left and right doors and lower adjustable leg whose door height is lower than the other until the both door height become level.
- Turn the adjustable leg for 1 turn makes approx. 1 mm door height change.
 - It will take several days until the legs fits the floor and the door height becomes stable.

- In case that the adjustable legs are difficult to turn:
 - Remove 2 screws and then remove the adjuster cover.
 - Insert a screw driver to a groove of the adjustable leg and turn.



Remove 2 screws (both sides)

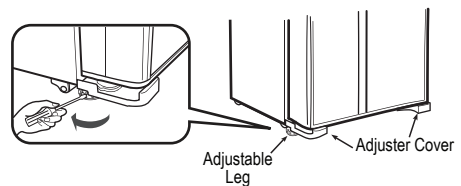

■ The left door is lower.

■ The right door is lower

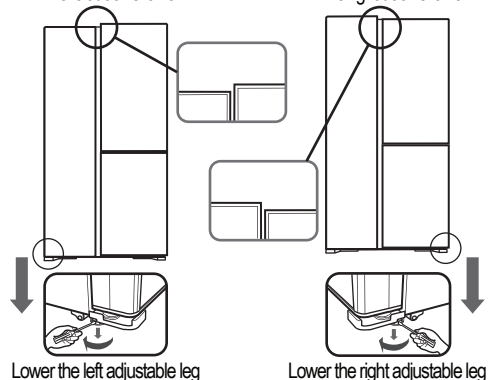

Lower the left adjustable leg

Lower the right adjustable leg

Preparation before Use

2 Before Use

A refrigerator is not an appliance that increases the freshness of food but it is an appliance to brake the food being spoiled to some extent. Please follow the User's Guide carefully and take proper actions to keep food fresh.

1. Cleaning inside the refrigerator.
 - Wipe the surface gently with wet soft cloth.
2. Connect the refrigerator to an exclusive wall power outlet.
 - The refrigerator can be connected to an outlet soon after it is installed.
 - Surely use with the rated voltage and exclusive power outlet.

NOTICE

- 30 seconds after the power is connected, the compressor will start.

3. Allow enough duration for sufficient cooling before storing food.
 - It may take about 4 hours to fully cool down and could even take about 24 hours when the ambient temperature is high.

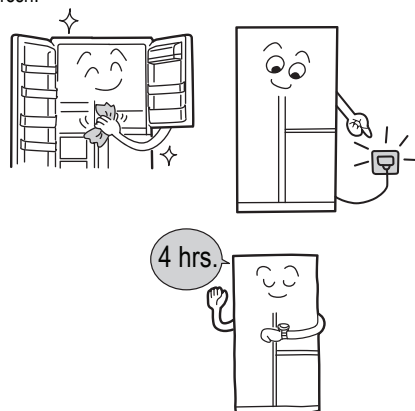

3 Optimal Food Storage

Keep enough space between food.

- Several food placed too close together may obstruct the flow of cold air. Keep enough space.



Make food cool enough before putting it in the refrigerator.

- Putting warm food in the refrigerator raises the inside temperature and wastes electricity.



Do not block the cold air vent.

- This will adversely affect the cool air flow and may not keep the temperature inside even. Moreover, it could result in food near the vent freezing.

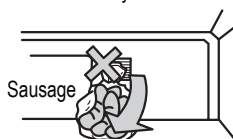

Keep the food wrapped or sealed and store.

- Using plastic wrap or sealed containers prevents the food from drying or transition of smells.

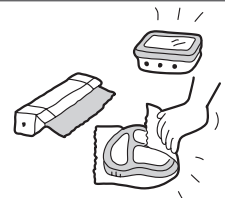

Keep food hygienic.

- A surprising amount of unhygienic substances can be found on food.



Do not place warm food on the chilled food.

- This will warm up the already chilled food.



Location of Food storage

Freezer Compartment -20°C~-18°C

Freezer Shelves

- Storage of frozen food and ice cream, etc.



Twist Ice Maker

- For making ice cube storage made by Twist Ice Maker



Freezer Door Pockets

- Storage of packed small frozen food
- Not recommended for long storage, because temperature rise caused by door open may occur.



Freezer Drawers

- Storage of packed meat, fish, etc.



Refrigerator Compartment 2°C~5°C

Refrigerator Door Pockets

- Storage of packed small food and drink such as juice, milk, etc.



Refrigerator Shelves

- Storage of side dish, dessert, etc.



Vegetable Drawer

- Storage of fruits and vegetable

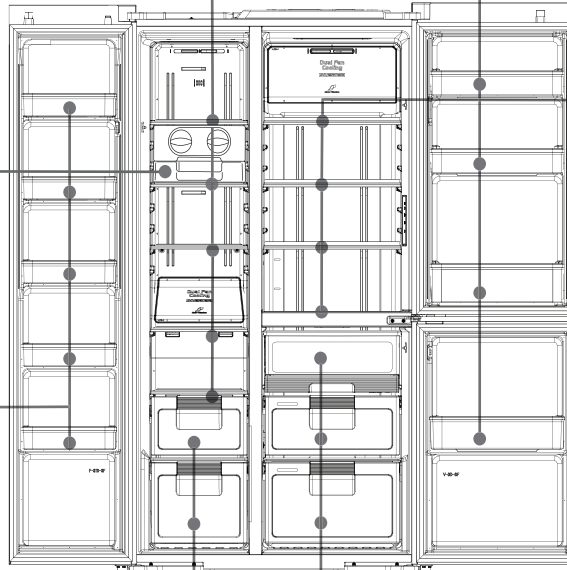

NOTICE

- Above temperatures are the approximate values in the conditions of outside temperature 32 °C, the setting of the refrigerator compartment, freezer compartment while doors being closed and without food storage is shown in the table.
- Door pocket temperatures may be little higher than above temperatures.
- The specification of your purchased model may be different from one of the above illustration. (Above illustration is based on the 3 door model.)

How to use Control panel

1

Name and Function of the Control Panel

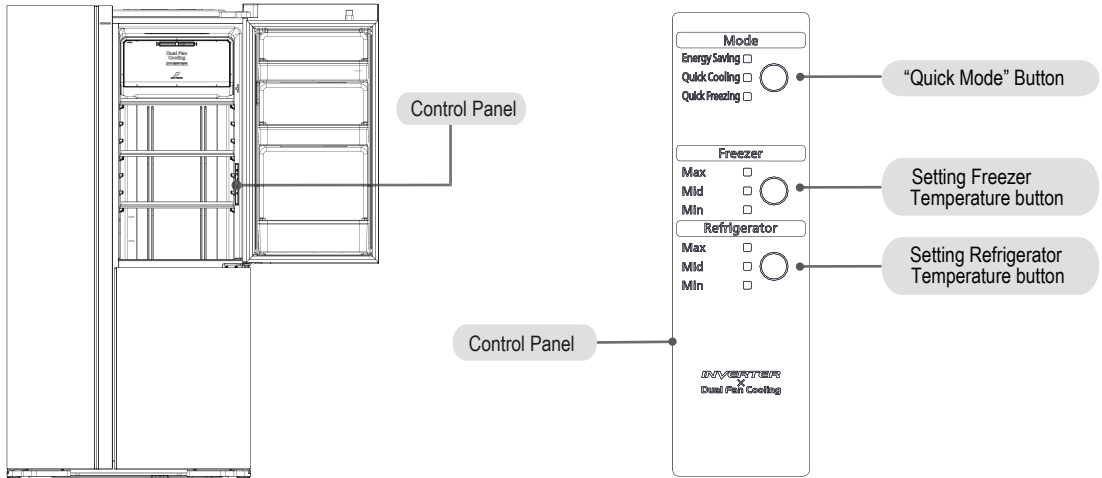

NOTICE

- The specification of your purchased model may be different from one of the above illustration. (Above illustration is based on the 3 door model.)

2

Temperature Control

- This refrigerator control its temperature automatically. Please adjust a temperature control dial as follows.

<p>Freezer</p> <p>Max <input type="checkbox"/></p> <p>Mid <input type="checkbox"/></p> <p>Min <input type="checkbox"/></p>	<p>When not storing frozen food or ice cream</p>	<p>Freezer</p> <p>Max <input type="checkbox"/></p> <p>Mid <input type="checkbox"/></p> <p>Min <input checked="" type="checkbox"/></p>	<p>For normal use.</p>	<p>Freezer</p> <p>Max <input type="checkbox"/></p> <p>Mid <input checked="" type="checkbox"/></p> <p>Min <input type="checkbox"/></p>	<p>When making ice quickly or making frozen food quickly or a surrounding temperature is high and the freezer compartment is not cold enough.</p>	<p>Freezer</p> <p>Max <input checked="" type="checkbox"/></p> <p>Mid <input type="checkbox"/></p> <p>Min <input type="checkbox"/></p>
		<p>Cold</p>		<p>Normal</p>		<p>Coldest</p>
<p>Refrigerator</p> <p>Max <input type="checkbox"/></p> <p>Mid <input type="checkbox"/></p> <p>Min <input type="checkbox"/></p>	<p>For food that doesn't need a lot of coldness.</p>	<p>Refrigerator</p> <p>Max <input type="checkbox"/></p> <p>Mid <input type="checkbox"/></p> <p>Min <input checked="" type="checkbox"/></p>	<p>For normal use.</p>	<p>Refrigerator</p> <p>Max <input type="checkbox"/></p> <p>Mid <input checked="" type="checkbox"/></p> <p>Min <input type="checkbox"/></p>	<p>When cooling food more coldly or quickly.</p>	<p>Refrigerator</p> <p>Max <input checked="" type="checkbox"/></p> <p>Mid <input type="checkbox"/></p> <p>Min <input type="checkbox"/></p>
		<p>Cold</p>		<p>Normal</p>		<p>Coldest</p>

Other Functions

1 How to use temperature control (Refrigerator compartment/ Freezer Compartment)

■ Setting

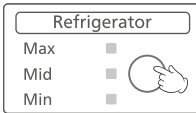

Press button "Refrigerator" for 5 seconds until 1 "Peep!" sound is heard.

■ Cancel

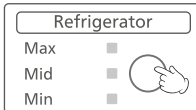

Press button "Refrigerator" for 5 seconds until 1 "PiPi!" sound is heard.

Open the Refrigerator door before press button "Refrigerator" to setting.

Each time you press the button, the corresponding indicator lamp changes in order shown below (9 steps).

(Lighting Blinking Turned off)

Indication lamp	Max		Max		Max		Max		Max		Max		Max		Max		Max		Max	
	Mid		Mid		Mid		Mid		Mid		Mid		Mid		Mid		Mid		Mid	
	Min		Min		Min		Min		Min		Min		Min		Min		Min		Min	
Setting	Min				Normal															Max

Open the Refrigerator door before press button "Refrigerator" to setting.

You can set temperature by normal step (3 steps).

NOTICE

- This function is subjected to change according model type.
- Factory setting, the adjustment temperature by normal step (3 steps).

2 Quick Freezing/Quick Cooling/Energy Saving

Quick Freezing : When you want to freeze food or make ice quickly, use this function

Quick Cooling : When you want to cool food or drinks quickly, use this function

Energy Saving : Recommend to use this function in case of low storage volume, or a long vacation when the doors are not opened for long time.

1

Press button "First time" for Start Quick Freezing operation, lamp light is on.

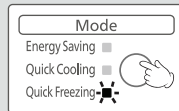

After 2 hours (approx.) Quick freezing operation will be finished, lamp light is off.

2

Press button "Second time" for Start Quick Cooling operation, lamp light is on.

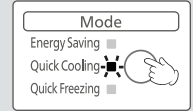

After 90 minutes (approx.) Quick cooling operation will be finished, lamp light is off.

3

Press button "Third time" for start two function operation, lamp both light is on.

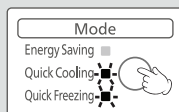

4

Press button "Fourth time" for Start Energy Saving operation, lamp light is on.

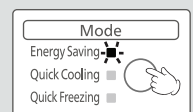

5

Press button "Fifth time" for stop all function operation lamp light is off.

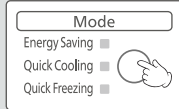

CAUTION

If "Energy Saving" operation is working in high humidity environment, dew may appear on refrigerator surface. Please stop "Energy Saving" operation in this case.

NOTICE

- During "Quick Freezing", priority cooling of the freezer compartment will be done. Thus, try to avoid unnecessary opening and closing the doors not to have a temperature rise of the refrigerator compartment.
- During defrost period, "Quick Freezing" and "Quick cooling" operation will stop even though the lamp is on. After finishing defrost period, the operation will restart automatically.
- Please note "Quick Freezing" and "Quick Cooling" mode will be released after power cut off or unplug.

Freezer Compartment

- The upper part of this compartment has 4 shelves. You can separate food by size and the way in which it is to be used.
- For information on temperature control read.

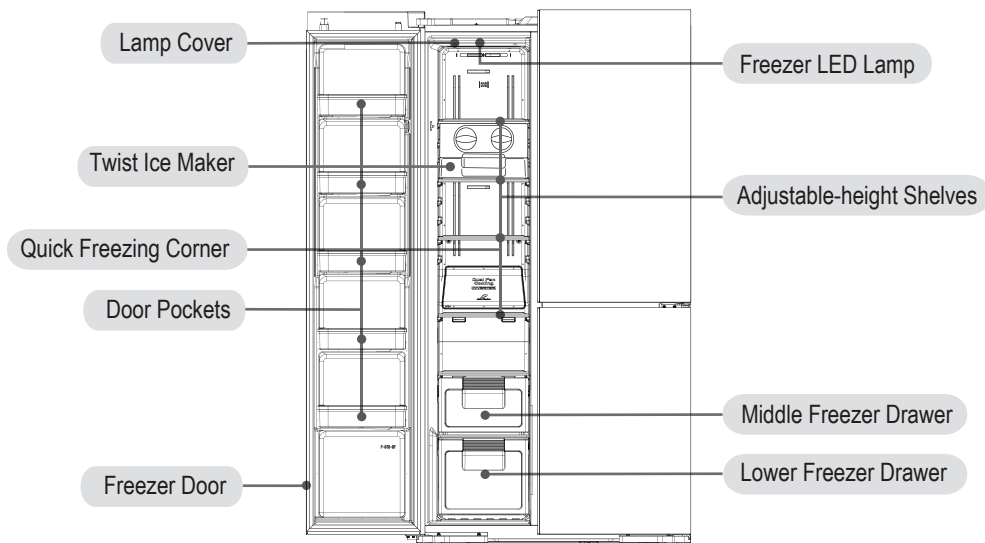

Quick Freezing

- Use this function to freeze your home food or to make ice quickly.
 1. Place food in the "Quick Freezing Corner" on the center shelf.
 2. Touch the "Quick Freezing" button.

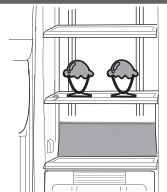

Adjustable-height Shelves

- These shelves can be adjusted to match the height of your frozen food and the way in which they are to be used.
 1. Remove the frozen food stored on the shelf.
 2. Lift the front of the shelf upward slightly, then pull the shelf out towards you.
 3. Adjust the shelf to the desired height, then push the shelf in until it reaches the back of the slot.

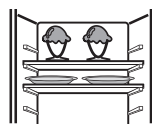
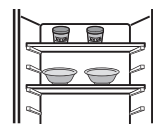
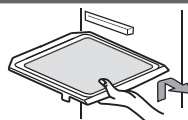

Freezer Drawers

- The freezer drawers can store food separately according to size or way in which they are to be used.
 1. Upper / Middle Freezer Drawer for storing ice cream or freezer bags.
 2. Lower Freezer Drawer for storing large frozen food items.

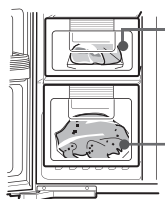

CAUTION

- When closing the freezer door, be sure that each freezer drawer is pushed all the way in. If the freezer door is closed while a drawer is still out, the freezer drawers might be damaged.

CAUTION

- To avoid smell transition of food, always either wrap meat or fish, or store it inside a freezer bag. Also, note that there are cases where fat in meat or fish causes the plastic refrigerator components to split.
- When putting food into the freezer compartment, try not to strike the lamp cover with the food. The lamp cover might break.

Freezer Compartment

■ Twist Ice Maker

■ How to Make Ice

1. Pull out the "Twist Ice Maker", and pour in water up to the full line.

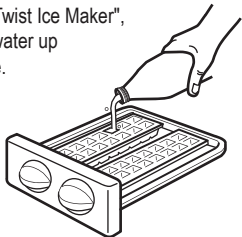

2. After ice is made, turn the lever clockwise firmly and drop the ice into the "Ice Bank".

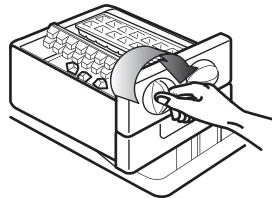

- When you wish to make ice especially quickly, use the "Quick Freezing" operation.

■ Location of the Twist Ice Maker

- The "Twist Ice Maker" can be used in both upper and lower positions.

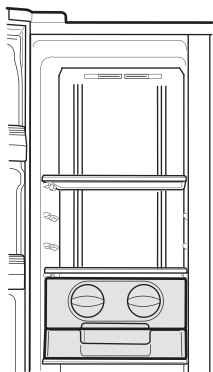

Lower Position

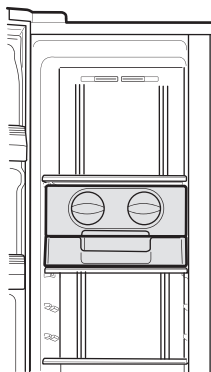

Upper Position

NOTICE

- Always align the "Twist Ice Maker" with the stopper position of the adjustable-height shelf.

CAUTION

- If the "Twist Ice Maker" is used in the absence of the stopper, the "Twist Ice Maker" might fall off of the shelf when the "Twist Ice Maker" or the "Ice Bank" is pulled out.

■ Ice Making Time

Ice Making Time		Ice Storage Capacity
Normal Operation	approx. 170-200 minutes	approx. 112 pieces
Quick Freezing	approx. 140-170 minutes	

- The ice making time is the average value for when the ambient temperature is 32 °C and the door is not opened and closed.

NOTICE

- The ice making time will be longer in the following situations.
 - When using the "Twist Ice Maker" for the first time (There are cases where 24 hours or longer is required.)
 - When the door is frequently opened and closed
 - When a large amount of food is placed inside the refrigerator at the same time
 - When there is a power outage
 - During winter, or when the surrounding temperature is low
 - After the ice tray has been serviced

Refrigerator Compartment

- The upper part of this compartment has 3 shelves, You can separate food by size and the way in which it is to be used.
- For information on temperature control read.

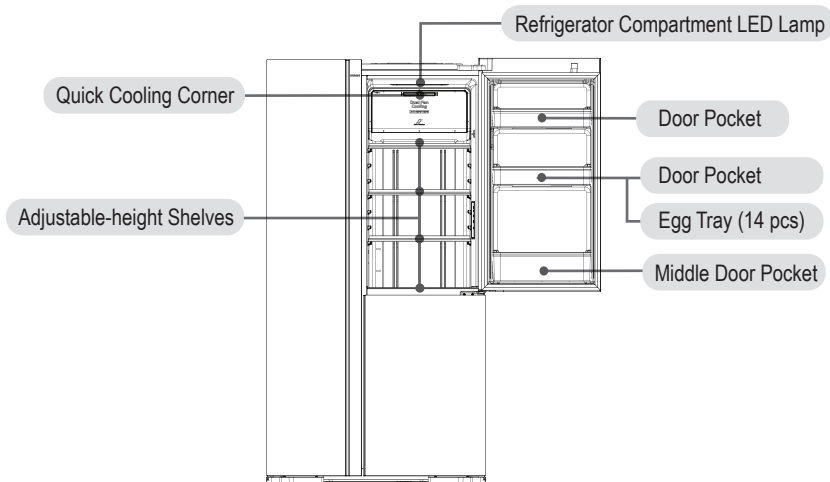

NOTICE

- The specification of your purchased model may be different from one of the above illustration. (Above illustration is based on the 3 door model.)

Quick Cooling

- Use this function to cool the food or drinks stored inside rapidly.
 - 1 Place the food in the "Quick Cooling Corner" on the top.
 - 2 Touch the "Quick Cooling" button.

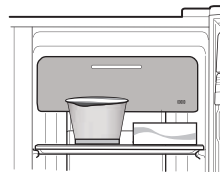

Adjustable-height Shelves

- The height of these shelves can be adjusted to match the height of your food and the way in which they are to be used.
 1. Remove all food stored on the shelf to be.
 2. Lift the front of the shelf upward slightly, then pull the shelf out towards you.
 3. Adjust the shelf to the desired height, then push the shelf in until it reaches the back of the slot.

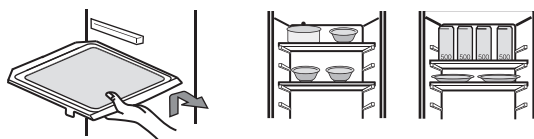

Egg Tray

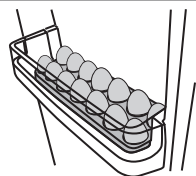

Egge Tray (Placed normally)

- Store eggs in the egg tray. (This tray holds up to 14 eggs.)

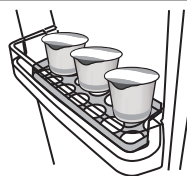

Egge Tray(Placed upside down)

- When turned over, The egg tray can be used as a pocket for small items.

CAUTION

- Do not place moist food in front of the cold air outlet, as this may cause food to freeze. Moist food stored such that it comes into contact with the back left wall of the refrigerator might also freeze. Keep food slightly separated from the left side wall of the refrigerator.
- When putting food into the refrigerator, try not to strike the lamp cover with the food. The lamp cover might break.
- Let hot cooked food cool down before placing it into the refrigerator. The plastic components inside the refrigerator might be deformed.

Vegetable Compartment

- Store vegetables efficiently according to their size and shape.
The lower part has 3 drawers.

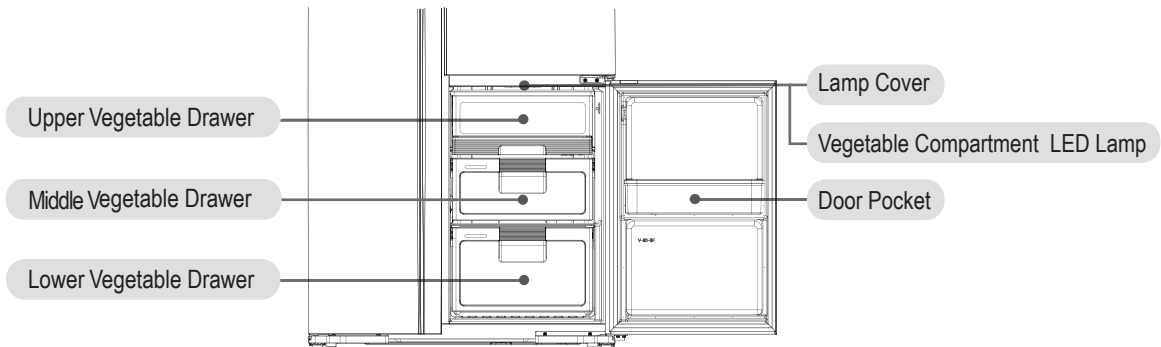

NOTICE

- The specification of your purchased model may be different from one of the above illustrations. (Above illustration is based on the 3 door model.)

Vegetable Drawers

■ Upper Vegetable Drawers

- Store partially used vegetables or small vegetables such as tomatoes or lemons. This drawer has a door, so it can be opened and closed easily.

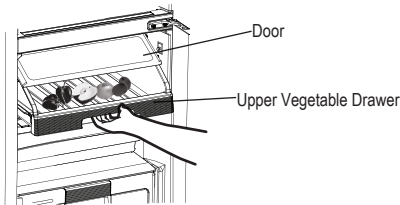

■ Middle and Lower Vegetable Drawers.

- Store medium and large-sized vegetables such as cabbage and lettuce.

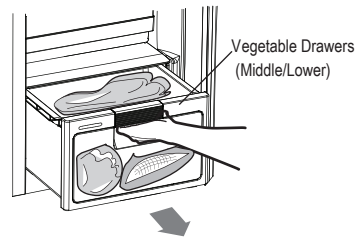

Wrap vegetables in the following situations.

- When storing strong-smelling vegetables or when you are worried that odors might spread to other food
- When storing partially used vegetables or fruits
- When you are concerned about condensation inside the drawer
- When there are few vegetables or many packaged vegetables

NOTICE

- Depending on the amount and type of stored vegetables, condensation might form inside or on the ceiling of the vegetable drawers. Wipe off any condensation with a dry cloth if this becomes a concern.

CAUTION

- When closing the vegetable compartment door, be sure that all vegetable drawers are pushed all the way in. If the vegetable compartment door is closed when a drawer is pulled out, it might be damaged.

Door Pocket

- This pocket is convenient for plastic bottles or temporarily stocking beer.

CAUTION

- Open and close the vegetable compartment door slowly. If you open or close this door with too much force, the plastic bottles or glass bottles in the door pocket might fall out.

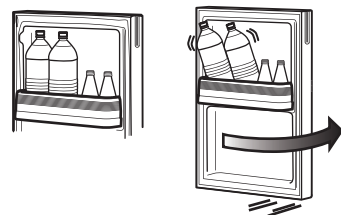

Maintenance (General Matter)

■ How to Maintain Your Refrigerator

1. Unplug the power cord.
2. Remove the food.
3. Wipe the refrigerator clean.

- It is the best if smudges are wiped off immediately. It is also recommended to clean the areas of the refrigerator not clearly in view once a year.
- Use a soft cloth moistened with lukewarm water to wipe off smudges. For difficult to remove smudges, use a diluted, neutral kitchen detergent, and then wipe off the smudges using a cloth moistened with lukewarm water.
 - The following parts can be cleaned with water:

Freezer Compartment	Refrigerator Compartment	Vegetable Compartment
<ul style="list-style-type: none"> ● Adjustable-height Shelves ● Fixed Shelf ● Freezer Drawers ● Door Pockets 	<ul style="list-style-type: none"> ● Adjustable-height Shelves ● Door Pockets ● Egg Tray 	<ul style="list-style-type: none"> ● Vegetable Drawers ● Vegetable Drawer Door ● Vegetable Drawers Cover ● Door Pocket

Door Surface

- To clean the door surface, wipe with a soft cloth wetted with lukewarm water.



Door Gasket

- This area is prone to smudges, so be sure to wipe it thoroughly.

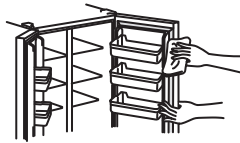

Drip Catcher

- Liquid that has accumulated here should be wiped away.



Back Panel, Floor of Refrigerator

1. Turn the leg adjuster to raise the refrigerator up off the floor.
 - If the adjuster does not turn easily, use a screwdriver to turn it. If it still will not turn, then remove the leg cover and try again.



3. Wipe off the smudges on the back panel, walls, and floor of the refrigerator.
 - Due to the convection of air, this is a place where fine dust is likely to adhere.

2. Pull the refrigerator straight out toward you.
 - For floors that are easily damaged, lay out a protective mat, or other protective material.



4. If any droplets remain on the surface of the parts that have been washed, wipe them.

5. Return all parts to their original locations.

6. Inspect and clean the power plug, cord and outlet.

Inspection

- Are there any cuts in the cord?
- Is the plug damaged or is the outlet loose and heating up excessively?
- When there is a problem with the power cord, plug, or outlet, please consult the retailer or the service center.



Refrigerator Care

- If the power plug is plugged in with dust on the power cord, it can result in fire.
- Remove all dust once a year and wipe with a dry cloth.



Maintenance (General Matter)

■ How to Maintain Your Refrigerator

Plug the power cord into the outlet.

- Insert the power plug into the outlet securely, all the way to the end with the power cord facing downward.

NOTICE

- Even if the power plug is plugged in immediately after being unplugged, the compressor will not run for 5 minutes. However, if the inside is not cold, it will start running in approximately 30 seconds.
- The evaporating tray for defrosting of this refrigerator does not need to be cleaned.

CAUTION

- Do not use the following : An alkaline or weak alkaline kitchen detergent, scouring powder, soap, petroleum, boiling water, scouring pads, acid, benzine, alcohol, or bleach (for details, see the Caution on the detergent package).
- When any cooking oil, citrus fruit juice, or juice from any food pours on this refrigerator, wipe it off.
- When using a chemical rag, be sure to heed the warnings for rag use.
- The doors, painted surfaces, and plastic parts may be scratched, or discolored by the chemical rag.

Parts Removal

■ How to remove parts

Upper Vegetable Drawer Door

- Push the lower right shaft backward, then push the entire right side to the back. Next, pull the left side forward towards yourself.

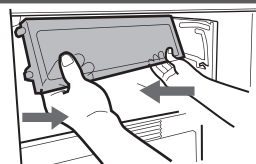
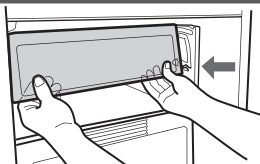

Drawers

- To remove drawers, pull them all the way out, then lift them upward.



Door Pocket

- Gently tap the left and right of the bottom surface while pulling a pocket up to remove it. When installing the pockets, push it all the way down in a smooth, controlled manner.



Adjustable-height Shelves/Fixed Shelf (Freezer)

- To remove a shelf, lift it up slightly, then pull it towards you. To install a shelf, push it in until it comes into contact with the end of the slot.

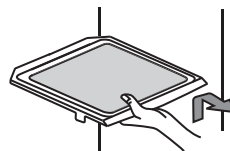

■ Replacing Lamp inside Refrigerator

⚠ WARNING

- Do not remove the cover of interior lamp
 - When the interior lamp is damaged, please contact the Hitachi service center or retailers for replacing the lamp to avoid injury.

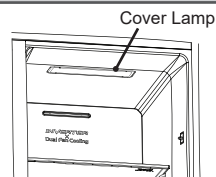

Troubleshooting

■ Check the Following First

- If the refrigerator still does not operate properly, contact the retailer from where it was purchased.

General Problems

Problems	Point to be checked	Detailed Check Points and Countermeasures	Page
Does not cool at all.	<ul style="list-style-type: none"> ● Is the power plug supplied ? 	<ul style="list-style-type: none"> ● Check the power supply at the wall outlet. ● Make sure the power supply cord is plugged firmly. ● Check the fuse box for blown fuse or tripped circuit breaker. 	-
Does not cool properly.	<ul style="list-style-type: none"> ● Was the refrigerator just installed ? 	<ul style="list-style-type: none"> ● Up to approximately 4 hours is required until your refrigerator cools properly. In the summer, up to 24 hours may be required. 	6
	<ul style="list-style-type: none"> ● Confirm that the refrigerator was installed properly. 	<ul style="list-style-type: none"> ● Is your refrigerator in contact with direct sunlight ? ● Is there a heat producing device such as a gas stove nearby ? ● Is there sufficient open space around your refrigerator ? 	5
	<ul style="list-style-type: none"> ● Is the freezer compartment temperature set to level 1 or 2, and is the refrigerator compartment temperature set to level 1 or 2 ? 	<ul style="list-style-type: none"> ● Set the freezer compartment temperature to level 3, and set the refrigerator compartment to level 3. 	8
	<ul style="list-style-type: none"> ● Check the inside of the refrigerator. 	<ul style="list-style-type: none"> ● Is there too much food in the refrigerator ? ● Are there any hot items inside ? ● Is the cold air outlet blocked by any food items ? 	6
	<ul style="list-style-type: none"> ● Is the door being opened frequently ? ● Is the door touching food and not completely closing ? ● Is there anything such as a plastic bag caught between the door gasket and the refrigerator main body, or are there any gaps? 	<ul style="list-style-type: none"> ● We recommend that you open and close the door quickly, and open and close it as little as possible. ● Confirm that there are no gaps when the door is closed. ● When the door is closed, be sure that no food or plastic bags are caught between the door and the refrigerator main body. 	-
	<ul style="list-style-type: none"> ● Is it a hot summer day ? 	<ul style="list-style-type: none"> ● Set the temperature inside the freezer compartment to level 4 or 5 and inside the refrigerator compartment to level 4 or 5. ● On very hot days, the cooling capacity could decrease, ice cream could become soft, and the temperature in the door pockets could increase. 	8
	<ul style="list-style-type: none"> ● Because the freezer compartment has priority to be cooled during "Quick Freezing" operation, the temperature inside the refrigerator compartment could increase. 	<ul style="list-style-type: none"> ● Avoid opening and closing the door as much as possible. 	9
Food in the refrigerator compartment and vegetable compartment freezes.	<ul style="list-style-type: none"> ● Is the temperature for the refrigerator compartment set to level 4 or 5 ? ● Is the ambient temperature 5 °C or less ? 	<ul style="list-style-type: none"> ● Change the temperature setting for the refrigerator compartment to level 3 or 2. When set to level 5, food might freeze. ● If the temperature in the refrigerator compartment is set to level 1, food is less likely to freeze. 	8
	<ul style="list-style-type: none"> ● Has any moist food been placed in front of the cold air outlet or at the back of a refrigerator shelf ? 	<ul style="list-style-type: none"> ● Moist food might freeze, so do not place it in front of the cold air outlet or at the back of a refrigerator compartment shelf. 	-
	<ul style="list-style-type: none"> ● Is any moist food being stored such that it is touching the back left wall of the refrigerator compartment ? 	<ul style="list-style-type: none"> ● Because the food is touching the freezer compartment partition whose temperature is comparatively low, the food might freeze. Either increase the temperature setting or move the food away from the compartment partition a little. 	6
Condensation (or frost) is forming.	<ul style="list-style-type: none"> ● When the humidity is so high, condensation might form on the outside of the unit, on the door gasket, or on the door. Also, after the door is opened and closed, the cold air might make the door surface fog up. This is not unusual. 	<ul style="list-style-type: none"> ● Wipe it off with a dry cloth. ● Condensation is less likely to form if the temperature setting for the freezer compartment is changed to level 3 or 2. 	8
	<ul style="list-style-type: none"> ● Is condensation forming on the vegetable compartment drawer ? 	<ul style="list-style-type: none"> ● This is because high humidity is maintained inside the drawer to prevent vegetables from drying out and to increase their life. Wipe with a dry cloth. 	-
	<ul style="list-style-type: none"> ● Is the door securely closed ? 	<ul style="list-style-type: none"> ● If there are any gaps between the door and the refrigerator main body, not only will the temperature inside increase, but condensation or frost could also form. Please close the door securely. 	-
	<ul style="list-style-type: none"> ● Is the door opened for a long time or opened and closed frequently ? 	<ul style="list-style-type: none"> ● Decrease the number of times the door is opened and closed, and open and close the door quickly. 	-
Water is collecting either inside the refrigerator or on the floor.	<ul style="list-style-type: none"> ● Is the door touching food, etc., and not closing completely ? 	<ul style="list-style-type: none"> ● If the door is not closed completely, condensation drips onto the inside of the refrigerator or on the floor. Please close the door completely. 	-
	<ul style="list-style-type: none"> ● Did any water in a plastic bottle spill ? 	<ul style="list-style-type: none"> ● Store bottled water so it does not spill. 	-

Troubleshooting

■ General Problems

Problem	Point to be checked	Detailed Check Points and Countermeasures	Page
The refrigerator is noisy.	<ul style="list-style-type: none"> Is the floor stable ? 	<ul style="list-style-type: none"> Install the refrigerator on a stable, level floor, or in a place with a stable board under it. 	5
	<ul style="list-style-type: none"> Is there any object between the refrigerator leg and the floor where it is installed ? 		
	<ul style="list-style-type: none"> Is the rear face touching a wall, etc. ? 	<ul style="list-style-type: none"> Install the refrigerator in a location with enough space around it. 	5
	<ul style="list-style-type: none"> Did the leg adjuster cover come off ? 	<ul style="list-style-type: none"> Securely attach the leg adjuster cover. 	5
The refrigerator is noisy. Some kind of sound is being made. (These sounds are not a sign of malfunction.)	<ul style="list-style-type: none"> Sometimes the normal operating sound of the refrigerator gets louder. 	<ul style="list-style-type: none"> After installation, the refrigerator operates at full power to cool its interior, so it will make a louder sound. 	-
	<ul style="list-style-type: none"> A sound like running water is emitted. A knocking sound. A sound like something is boiling (a bubbling sound). A sizzling sound like when meat is being cooked. 	<ul style="list-style-type: none"> This is the sound of the cooling fluid (refrigerant) flowing through the cooling device. This sound might also be heard when the compressor has stopped. 	-
	<ul style="list-style-type: none"> A sound like something stuck in a machine. A whirring sound. 	<ul style="list-style-type: none"> This is the sound of parts, such as the motor, which control the temperature inside the refrigerator running. 	-
	<ul style="list-style-type: none"> A cracking sound. (This is heard inside the refrigerator when the door is opened). 	<ul style="list-style-type: none"> This is the sound of the plastic creaking due to a change in temperature (when the door is opened). 	-
	<ul style="list-style-type: none"> A hissing sound right after the door is closed. 	<ul style="list-style-type: none"> This is the sound of a temporary drop in air pressure when the air that entered into the refrigerator is suddenly cooled. 	-
Unpleasant odor inside the refrigerator.	<ul style="list-style-type: none"> Has strong-smelling food been put inside without being wrapped ? 	<ul style="list-style-type: none"> The deodorizing function will not remove all odor. Either wrap or seal such foods. 	6
	<ul style="list-style-type: none"> Food smells like plastic. 	<ul style="list-style-type: none"> This is because many plastic parts are used inside the refrigerator. As your food cools, the odor will gradually go away. 	-
The front and back of the refrigerator is warm. Warm wind blows out from the bottom.	<ul style="list-style-type: none"> The heat exhaust pipe and fan release the heat inside the refrigerator, so they might become hot. 	<ul style="list-style-type: none"> The temperature in these locations might reach 50 °C to 60 °C immediately after your refrigerator is installed. This is not abnormal. 	-
Very weak electrical shock is felt when touching the main body.	<ul style="list-style-type: none"> The refrigerator occasionally accumulates static electricity, but this is not a safety concern. 	<ul style="list-style-type: none"> If this becomes an annoyance, earthing the refrigerator main body is recommended. 	5
The door feels heavy when trying to open it right after being closed.	<ul style="list-style-type: none"> This is caused by a temporary drop in air pressure due to the suddenly cooling of the air entering inside the refrigerator. 	<ul style="list-style-type: none"> The door might feel heavy for a moment, but it will soon feel normal again. 	-
When one door is closed, the other door opens.	<ul style="list-style-type: none"> The compartments are connected by a cold air pathway, so the air pressure from the closing of one door might cause the other door to open temporarily. 	<ul style="list-style-type: none"> Closing the doors slowly will eliminate this problem. 	-
The panel display keeps changing	-	<ul style="list-style-type: none"> This indicates that the refrigerator is running in store-display mode. The refrigerator will not cool while running in store-display mode. Turn off the store-display mode by: <ol style="list-style-type: none"> Power off and Power on the refrigerator again. After that the refrigerator will return to normal mode. 	-

Troubleshooting

■ Dew or Frost is generated

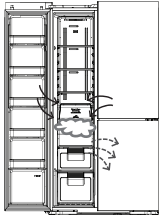
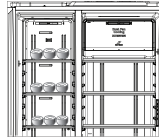
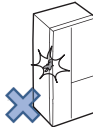
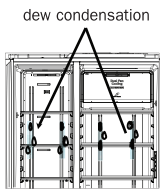
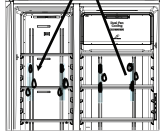
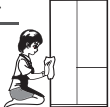
General operation	Please check here	Possible causes and / or Recommended solutions
Frost or ice is generated in the freezer compartment	The door of the freezer compartment was not open temporarily?	Check that the wrapping paper of the food is not getting caught in order not to make gap between door and door gasket when you close the door. 
	The door of the freezer compartment was not opened frequently or longer time than necessary?	When the door is opened frequently or if the door is opened when the humidity around the refrigerator is high, moisture in the air may be turned into some frost or ice on the inner wall or component of the freezer compartment, or around the air channels. This is not a failure. Please try not to open the door too many times or for a long time. Also, please wipe frost or ice generated in the freezer compartment off with use of a dry cloth. 
	Making extra ice by using an additional ice-tray which was not originally installed in the refrigerator?	When the many containers in which water or liquid is stored are put in the same time, water or liquid may be evaporated and turned into frost or ice on the wall or component of the freezer compartment, or around the air channels. You can suppress these frost and ice by putting lid to avoid evaporation. Please wipe frost and ice off with use of a dry cloth. 
Dew is generated in the refrigerator compartment	The door of the refrigerator compartment was not left open temporarily?	Please check not to pinch the food or plastic bag between the door and door frame when you close the door. 
	The door of the refrigerator compartment was not opened frequently or longer time than necessary?	When the door is opened frequently or if the door is opened when the humidity around the refrigerator is high, moisture in the air may be turned into some dew on the inner wall or component of the refrigerator compartment, or around the chilled air blow-off port. This is not failure. Please try not to open the door too many times or for long time. Also, please wipe off the dew in the refrigerator compartment with a dry cloth. 
	Storing many vegetables containing much water?	The humidity of the vegetable compartment is higher than other compartments. Accordingly, depending on the amount or type of the vegetable, dew condensation may be generated on the plastic case of vegetable compartment. However, this is not a failure. When you do not want to have this kind of dew, please wrap your vegetables in a plastic film. Also, when the dew condensation happens many times, water may be accumulated in the vegetable compartment. Please wipe the water off with a dry cloth. 
Dew is generated on outer surface of the refrigerator	The volume of humidity around the refrigerator is not high?	When the humidity rises such as in rainy day, some dew may be generated on the outer surface of the refrigerator. Please wipe the dew off with a dry cloth. 
	The temperature setting is not set as "Coldest"?	When the temperature setting is set as "Coldest", some dew may be generated on the outer surface of the refrigerator. Please set the setting as "Normal". Also, please wipe dew off with use of a dry cloth.

Why Dew and Frost are generated?

When warm and humid air contacts something cold, dew is generated. For example, if you put some ice in the glass in your room, air around the glass will be cold down and some dew may be generated on the outer surface of the glass. 

In the same way, when warm and humid air enters into the refrigerator at the door opening, the warm and humid air contacts cold inner wall and little dew may be generated.

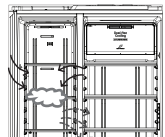
Accordingly, if the door opening is too frequent or too long, dew will be accumulated at every door opening. In some cases, dew may be frozen to generate some frost or ice flakes in the freezer compartment. 

Troubleshooting

■ What to do in these situations

This is not a malfunction of the refrigerator.

The surface of the refrigerator is hot	<ul style="list-style-type: none"> The refrigerator is equipped with the dew prevention and heat radiation tubes. The back and side plates may be heated especially when starting up or if the door is frequently opened and closed.
If a door is shut, other doors may open.	<ul style="list-style-type: none"> The two compartments are connected with an air duct. When closing one of the doors, the door may be opened by the air pressure through the duct. This is a normal phenomenon.
Does the refrigerator make any abnormal noise(sound)?	<ul style="list-style-type: none"> The sound like water flowing and boiling water is the sound of the cooling liquid (refrigerant). A creaking sound comes from the storage compartment. It is the sound caused by friction of the parts due to temperature change
Annoying sound is generated by the refrigerator.	<ul style="list-style-type: none"> You may feel that the operation sound is larger because the compressor operates in high-speed under the following conditions: The refrigerator does not cool fully on the occasion such as using it for the first time, opening/closing the door frequently, the surrounding temperature is high. The sound becomes more quiet after cooling fully. The compressor operates at low speed at night, for long vacations or absences, potentially creating large vibrations.
Operation sound lasts long.	<ul style="list-style-type: none"> It is because the compressor operates in low-speed for conserving energy
Operation sound sometimes becomes louder.	<ul style="list-style-type: none"> It is because the system changes the operating power of the refrigerator according to the temperature change.

Service Center

• Before you request repair, please check the refrigerator well according to page number 16-19. If it is still abnormal, please contact the retailer of purchase or the following service center.

Service Center	TEL No.
<ul style="list-style-type: none"> Arcelik Hitachi Home Appliances Sales Malaysia Sdn.Bhd. Arcelik Hitachi Home Appliances Sales (Singapore) Pte. Ltd 	<ul style="list-style-type: none"> 1-800-88-1122 62787177

• Telephone number is subject to change without notice.

About Non-fluorocarbon refrigerator.

- This refrigerator, including refrigerant and the heat insulator, is using hydrocarbon (non-fluorocarbon). The hydrocarbon is a material that does not rip up the ozone and have very little influence on global warming. It is the global environment concern material).
- R600a refrigerant is flammable. But the refrigerant is sealed up by the refrigerate circuit, and never leaks by usual use. In case of the refrigerant circuit being damaged by any chance, please avoid the use of fire and electric product , open the window and ventilate. Afterwards, please contact Hitachi Service Center.

Severe warning signs for Disposal

Cyclopentane is used as in the insulation. The gases in insulation material require a special disposal procedure. Please contact your local authorities in regard to the environmentally safe disposal of this product.



This symbol mark means that used electrical and electronic products shall not be mixed with general household waste. Do not try to dismantle the system and unit by yourself as this could have harmful effects on your health and the environment. Refrigerators must be treated at a specialized treatment facility for recycling and recovery and shall not be disposed of in the municipal waste stream. Please contact the installer, dealer or local authority for more information.

HITACHI



430-HRPK2549A_INS-B-SBS20-EN-STD (AB)