

Instruction Manual

Refrigerator

No frost

Model

HRSN9552D

HRSN9552DXMY

HRSN9552DDXMY

HRSN9552DDXSG



Thank you very much for purchasing the Hitachi refrigerator.
Before installation and usage, please read the user's guide carefully
for the correct usage.

Maintenance work must only be carried out at works
by well-trained maintenance work.

HITACHI

Content

Warning and Caution for Safety.....	2
Product Features	5
Preparations before Use	6
Functions	7
Instructions for food storage	8
Tips for special needs	9
Maintenance and cleaning	9
Simple fault analysis and elimination (varying with different products)	10
Certifications (to be provided by Certification Engineer)	11
Safe recovery instructions	11
Dew or Frost is generated	12
Service Center	13

For household use only

R600a
Refrigerant

Warning and Caution for Safety

To avoid harm to the user, other persons or damage to property, please read and follow the warnings and cautions below and those given throughout this manual.

The following warnings and cautions are categorized by the level of possible harm or damage that may occur from ignoring directions.

This symbols are shown as below clearly showing the significance of directions.



WARNING

This pictograph indicates "There is a high possibility of serious injury or death, if ignored".



CAUTION

This pictograph indicates "There is a high possibility of injury or damage to property, if ignored".

- This refrigerator use flammable refrigerants. The symbol column below states the precautions on flammable refrigerants.

The symbols below are examples.



This symbols is an alert mark.



This symbols indicates "prohibited".



This symbols indicates "necessary".



This symbol denotes the precautions on flammable refrigerants.



WARNING

When you install ... To avoid fire, electric shock, and injury.

- Do not install the refrigerator in a place where it may come in contact with water.
- Do not install the refrigerator in a place exposed to rain.
 - This may impair electricity insulation and cause electric shock or fire.
- Ground this refrigerator to prevent electric shock and noise interference. Always ground this refrigerator and install earth leakage circuit breaker when using it in place with high humidity or moisture. (Please consult with a retailer or Hitachi Service Center.)

Power Cord and Power Plug ... To avoid fire, electric shock.

- Do not connect the wall outlet whose power capacity is less than the refrigerator's. Also, do not use power sources that are not a rated voltage.
 - If a power source is shared with other appliances using double or multipoint adapters.
 - Do not locate multiple portable socket-outlets or portable power supplies at the rear of the appliance.
- Do not use a damaged or loose power plug or power outlet. This may cause fire or electric shock.
- Do not cut, bend, fold the power cord to avoid fire and electric shock.
 - When positioning the appliance, ensure the supply cord is not trapped or damaged.
- Be sure to unplug the power plug before maintaining the refrigerator.
 - Be sure to hold the power plug to unplug.
- Connect the power plug firmly to a power outlet with the cord running down.
 - Connection of the power plug with the cord running up could apply stress on the cord and cause electrical short or overheat, which could result in electrical shock or fire.
 - Incomplete connection of the power plug could result in electrical shock or fire due to heat.
- If the supply cord is damaged, it must be replaced by the manufacturer, its service agent or similarly qualified persons in order to avoid a hazard.
- Clean the dust on the power plug frequently with dry cloth.
 - Unplug the power plug and wipe it with dry cloth.
 - An insulation failure due to moisture or when dust collects on the power plug may cause fire.
- Do not insert or remove the power plug with wet hands.

During daily use ... To avoid fire, electric shock.

- Do not splash water on or inside the refrigerator.
 - This may impair electricity insulation causing electric shock or fire.
 - This may also cause gas leakage because of pipe rust.
- This appliance is not intended for use by persons (including children) with reduced physical, sensory or mental capabilities, or lack of experience and knowledge, unless they have been given supervision or instruction concerning use of the appliance by a person responsible for their safety.
- Do not hang on the doors or step up on the various compartments.
 - Injury may be caused by the refrigerator tipping over or hands getting caught in door.
- Do not enter in the refrigerator.
- Do not disassemble, repair, or modify the refrigerator by yourself.
 - Please consult with a retailer or Hitachi Service Center if any repair is required.
- Ether, liquid propane gas, solvent, aerosol cans, etc. which is volatile cannot be stored in this refrigerator.
 - Do not store anything that are generate heat or fire spark inside the refrigerator.
- Do not put water containers or foreign articles on the top of the refrigerator.
 - Opening and closing doors etc. may cause the articles on the top of the refrigerator to fall down, resulting in injury.

! WARNING



- Do not damage the refrigerant circuit.
 - If there the damage of refrigerant pipe happened, stay away from the refrigerator and avoid using fire and electrical appliances.
 - And, open windows to ventilate and contact retailers or Hitachi Service Center.

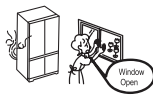

- Medicines, chemicals, research and experimental substances should not be stored in the refrigerator.
 - Substances that require precise conditions for storage cannot be stored in a domestic refrigerator.



- Do not use electrical appliances inside the food storage compartments of the appliance, unless they are of the type recommended by the manufacturer.



- Do not use mechanical devices or other means to accelerate the defrosting process, other than those recommended by the manufacturer.



- In an event of a flammable gas leak, do not touch the refrigerator and open windows for ventilation.
 - Sparks from points of electrical contacts such as door switches may ignite explosions causing fire or a burn.



- Children should be supervised to ensure that they do not play with the appliance.
 - Children getting inside may not be able to get out.
- Cleaning and user maintenance shall not be made by children without supervisor.



- Do not use the refrigerator in the atmosphere of flammable gas.



- Do not make an impact on the glass-made doors or shelves.
 - They are made of tempered glass, however, an excess impact may be result in breakage and is dangerous.



- If you find something wrong with the refrigerator, immediately unplug and consult with the retailers or Hitachi Service Center.



- This appliance can be used by children aged from 8 years and above and persons with reduced physical, sensory or mental capabilities or lack of experience and knowledge if they have been given supervision or instruction concerning use of the appliance in a safe way and understand the hazards involved.
- Children shall not play with the appliance.

- Keep ventilation openings in the appliance enclosure or in the built-in structure clear of obstruction.



When discarding the refrigerator.



- When discarding the refrigerator, remove the door gaskets.
 - To avoid a risk of an infant or child to be entrapped inside.



- Follow the instructions of your region when discarding.
 - This refrigerator uses R-600a for the refrigerant and cyclopentane for the blowing agent of the urethane heat insulation.



! CAUTION

During daily use ...To avoid illness and injury.



- Do not put bottles, etc. forcibly in the door pockets.
 - This may cause bottles to drop down or door pockets to come off.



- Do not store food which smells or food whose color is changed abnormal.
 - Such an action may cause diseases.



- Food and containers inside the freezer compartment should not be touched with wet hands.
 - This may cause frost injury. (Especially in case of metal items.)



- Do not hold the top, bottom and side of the doors when closing them.
 - This may result in your fingers being caught by the door edge.



- If someone else is using the refrigerator, do not open the door.
 - Fingers may get caught in the spaces between the doors and may cause injury.



- Do not have food items protruding over the front edge of each shelf.
 - Doors may not be closed properly or the door pockets may drop down. Injury may be caused from items like bottles getting knocked over your feet.

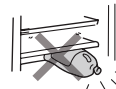

- Do not store glass bottles in the freezer compartment.
 - Bottles may break by the contents freezing and cause injury.



- Do not put your hands into the base surface of the refrigerator cabinet.
 - When cleaning, putting your hands near the base surface of the refrigerator may result in injury by thin metal sheets.



- Be sure to hold the handle firmly to open or close the door.



- Do not have your feet too close when opening the door of the refrigerator.
 - When opening the door, your feet may be hit, resulting in injury.



When moving or carrying ... To avoid damaging, wetting, soiling the floor, or to avoid injury.



- Use the carrying handle when carrying the refrigerator.
 - Hold the carrying handles only. If hold door handles, hands may slip and may cause injury.
 - Carry the refrigerator by at least 4 persons for safety reasons.
 - Carry it with the doors facing upward.

- Before carrying the refrigerator:
 - Take out all food items and ice cubes.
 - Lay a protective sheet or cloth to protect the floor from damage and catch remaining water spilled from the refrigerator.
 - With a large piece of old cloth underneath, tilt the refrigerator backward to drain water.
 - Finally carry the refrigerator with the doors facing upward.
 - Secure the doors well with adhesive tapes so they do not open.
 - If transporting in a vehicle, do not load the refrigerator on its side. This could damage the compressor.



- Do not use door handles when carrying the refrigerator.
 - Never use the carrying handles to hang up with a chain hoist or similar machines.



- On a floor that is easily scratched, do not move the refrigerator with the wheels of refrigerator.
 - The wheels may scratch the floor.
 - For a floor that may be easily scratched, lay a protective mat, etc..



When replacing lamps (LED) is required.



- When lamps (LED) need to be replaced, please contact Hitachi Service Center.

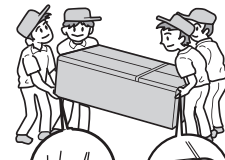
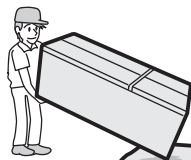

Such as old cloth

⚡ WARNING ⚡

Electrical Connection

The power cord of this appliance is equipped with a plug which mates with the standard wall outlets to minimize the possibility of electrical shock.

Under any circumstances, ensure that the power cord is grounded.

This refrigerator appliance requires a standard 220-240VAC 50/60Hz electrical outlet with grounding.

This refrigerator appliance is not designed to be used with an inverter.

The cord should be secured behind the appliance and not left exposed or dangling to prevent accidental injury.

Never unplug therefrigerator by pulling the power cord. Always grip the plug firmly and pull straight out from the receptacle.

Do not use an extension cord with this appliance. If the power cord is too short, have a qualified electrician or service technician install an outlet near the appliance. Use of an extension cord can negatively affect the performance of the unit.

Improper use of the grounded plug can result in the risk of electrical shock.

If the power cord is damaged, have it replaced by an authorized service center.

Climate Range

The information about the climate range of the appliance is provided on the rated plate.

It indicates at which ambient temperature (that is, the room temperature in which the appliance is working) the operation of the appliance is optimal (proper).

Climate range	Permissible ambient temperature
SN	from +10°C to +32°C
N	from +16°C to +32°C
ST	from +16°C to +38°C
T	from +16°C to +43°C

Note: Given the limit values of the ambient temperature range for the climate classes for which the refrigerating appliance is designed and the fact that the internal temperatures could be affected by such factors as location of the refrigerating appliance, ambient temperature and the frequency of door opening, the setting of any temperature control device might have to be varied to allow for these factors, if appropriate.



Note: When operating in an environment other than the specified climate type (i.e., beyond the rated ambient temperature range), the appliance may not be able to maintain the desirable compartment temperatures.

Locks

If your Refrigerator is fitted with a lock, keep the key out of reach and not in the vicinity of the appliance to prevent children being entrapped. When disposing of an old Refrigerator, break off any old locks or latches as a safeguard.

Freon-free

The freon-free refrigerant (R600a) and the foaming insulation material (cyclopentane) that is environmentally friendly are used for therefrigerator, causing no damage to the ozone layer and having very small impact on the global warming. R600a is flammable, and sealed in a refrigeration system, without leakage during normal use. But, in case of refrigerant leakage due to the refrigerant circuit being damaged, be sure to keep the appliance away from open flames and open the windows for ventilation as quickly as possible.

Product Features

This is a side-by-side inverter fridge-freezer adopting the electronic control mode. Its right part is the fridge compartment for fresh food storage, such as fruits, vegetables, eggs, milk, cooked foods, etc.; and its left part is the freezer compartment where fish, meat, etc. can be frozen for the long-term storage.

★Computer control

Adopting the electronic temperature control, the fridge-freezer is designed with a LED display screen, by which the temperature of each compartment and the working parameters can be managed and set.

★Inverter technology

Integrated with precise frequency conversion, noise reduction, energy saving, precise temperature control and other technologies, the fridge-freezer boasts of superior performances. Furthermore, working efficiency of the inverter compressor can be automatically adjusted according to the ambient temperature and the set temperature, to keep the fridge-freezer operating in its optimal state.

★Green technology

The freon-free refrigerant and foaming insulation material are used for the fridge-freezer, causing no damage to the ozone layer and having a very small impact on the global warming, so it is the environmentally friendly product.

★Stylish appearance

Adopting the optimized man-machine engineering design, the side-by-side refrigerator has an elegant and novel appearance, and is easy to be opened.

★More user-friendly designs

Such functions as wide working voltage range, automatic temperature control, power-off memory, power-on delay, automatic alarm, fast freezing, and fridge power-off, etc. are available.

Explosive views

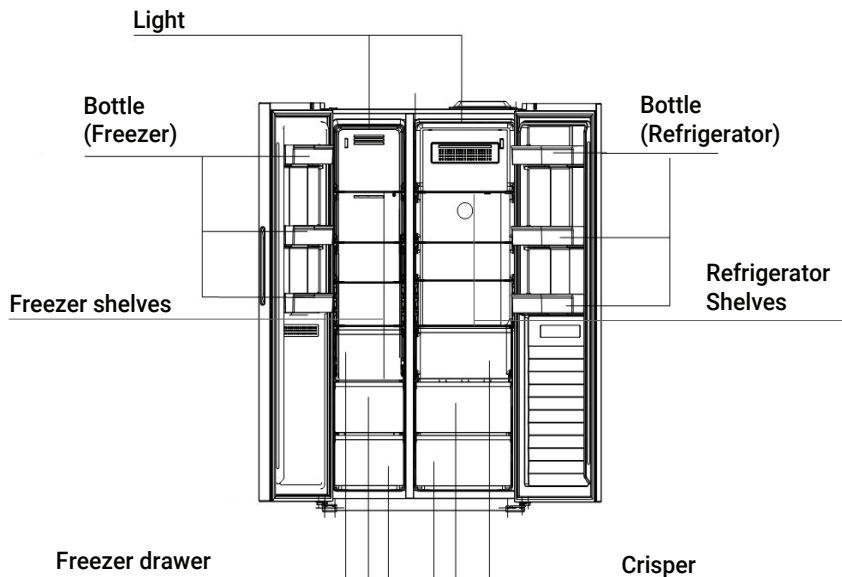

Note: This illustration is only for the interior, the product descriptions in this manual may not be completely consistent with your refrigerator. Details are in accordance with the real product.

Preparations for use

Installation location:

1. Ventilation condition

The position you select for the refrigerator installation should be well-ventilated and has less hot air. Do not locate the refrigerator near a heat source such as cooker, boiler, and avoid it from direct sunlight, thus guaranteeing the refrigeration effect while saving energy consumption. Do not locate the refrigerator in the damp place, so as to prevent the refrigerator from rusting and leaking electricity. The result of the refrigerant charge amount of the refrigerator being divided by the total space of the room in which the refrigerator is installed shall be less than $8\text{g} / \text{m}^3$.

Note: The amount of refrigerant charged for the refrigerator can be found on the nameplate.

2. Heat dissipation space

When working, the refrigerator gives off heat to surroundings. Therefore, at least 30mm of free space should be spared at the top side, more than 100mm on both sides, and above 50mm at the back side of the refrigerator.

Dimensions in mm:

W	D	H	A	B	C (°)	E	F
912	642	1762	1448	1093	120	50	100

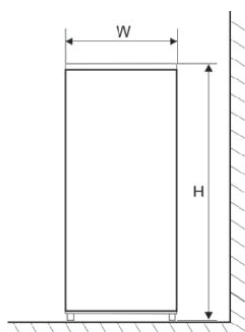

Figure 1

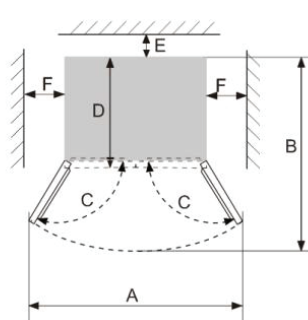

Figure 2

Note: Figure 1, Figure 2 only illustrate the space demand of the product.

3. Level ground

Place the refrigerator on the solid and flat ground (floor) to keep it stable, or else, it will give rise to vibration and noise. When the refrigerator is placed on such flooring materials as carpet, straw mat, polyvinyl chloride, the solid backing plates should be applied underneath the refrigerator, so as to prevent color change due to heat dissipation.



Unobstructed ventilation shall be maintained around the appliance or in an embedded structure.

Preparations for use

1. Standing time

After the refrigerator is properly installed and well cleaned, do not switch it on immediately. Make sure to energize the refrigerator after more than 1 hour of standing, so as to ensure its normal operation.

2. Cleaning

Confirm the accessory parts inside the refrigerator and wipe the inside with a soft cloth.

3. Power-on

Insert the plug into the solid socket to start the compressor. After 1 hour, open the freezer door, if the temperature inside the freezer compartment drops obviously, it indicates the refrigeration system is working normally.

4. Storage of food

After the refrigerator runs for a period of time, the internal temperature of the refrigerator will be automatically controlled according to the user's temperature setting. After the refrigerator is fully cooled, put in foods, which usually need 2~3 hours to be fully cooled. In summer, when the temperature is high, it takes more than 4 hours for the foods to be fully cooled (Try to open the refrigerator door as less as possible before the internal temperature cools down).

If the refrigerator is installed in the moisture place, make sure to check whether the ground wire and leakage circuit breaker are normal. If vibration noises are produced due to the refrigerator contacting the wall or if the wall gets blackened by air convection around the compressor, move the refrigerator away from the wall. Setting up the refrigerator may cause jamming noise or image chaos to the mobile phone, fixed-line telephone, radio receiver, television set surrounding it, so try to keep the refrigerator as far away as possible in such case.

Functions

The display panel is designed on the fridge door, illustrated as the figures below:

Function Setting When the refrigerator system is connected to power supply for the first time, all icons on the display panel gets illuminated for 5s. When all the doors are close, the display gets extinguished automatically if no key operation within 3 minutes. When the display is off, it will light up if any door is opened or any key is pressed. The following key operations are valid only when the keys are unlocked and gets illuminated on the display.

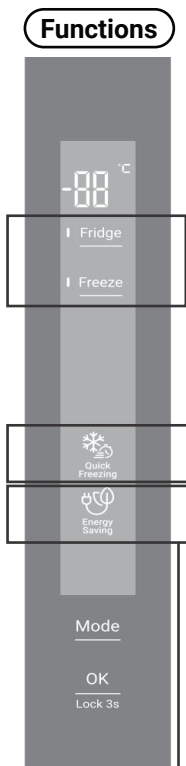

Functions

1.1 Temp. setting

1) Fridge temperature setting

Press the **Fridge** key to adjust the temperature of the fridge compartment to the expected temperature mode, and then press the "OK" key within 5 seconds to validate the setting, with the flickering of the current temperature setting stopped. The fridge temperature setting cycles as following:

5°C → 6°C → 7°C → 8°C → OF → 2°C → 3°C → 4°C → 5°C

'OF' represents the OFF state, and when the OF setting takes effect, the fridge will be shut off, with the icon " °C " extinguished.



Be sure to take out all the foods in the fresh food compartment before setting this function.

2) Freezer temperature setting

Press the **Freeze** key to adjust the temperature of the freezer compartment to the expected temperature mode, and then press the "OK" key within 5 seconds to validate the setting, with the flickering of the current temperature setting stopped. The freezer temperature setting cycles as following:

-18°C → -17°C → -16°C → -24°C → -23°C → -22°C → -21°C → -20°C → -19°C → -18°C

1.2 Quick Freezing

1) When the Quick Freezing function is enabled, the icon of Quick Freezing gets illuminated, with the indicator light of the freezer temperature off and the freezer temperature controlled at -32°C automatically. After 26 hours of running, the Quick Freezing function gets exited. Cooling down the freezer temperature in a rapid manner is beneficial to the prevention of food nutrition against lost and the preservation of freshness.

2) Enabling the Quick Freezing function

◆ Press the Mode key to select Quick Freezing until the corresponding icon gets flickering, and then press the "OK" key within 5 seconds to validate the setting, with the icon of "Quick Freezing" normally On.

3) Exiting the Quick Freezing function

- ◆ After a cumulative running period of 26 hours, the Quick Freezing function will exit automatically. Under the Quick Freezing mode, press the Mode key to select Quick Freezing until the corresponding icon gets flickering, and then press the "OK" key within 5 seconds to validate the setting, with the icon of "Quick Freezing" extinguished and the fast-freezing function disabled.
- ◆ When the freezer temperature is adjusted, the function of Quick Freezing gets exited automatically.
- ◆ When the Energy Saving function is enabled, the Quick Freezing function will be disabled automatically.

1.3 Energy Saving

1) When the energy Saving is enabled, the temperature of the fresh food compartment is controlled at 5°C, and that of the freezer compartment at -18°C, so that foods can be stored in the best condition while the refrigerator is running more efficiently and with better performance.

2) Enabling the Energy Saving function

Press the Mode key to select Energy Saving until the corresponding icon gets flickering, and then press the "OK" key within 5 seconds to validate the setting, with the icon of "Energy Saving" normally On.

3) Exiting the Energy Saving function

- ◆ Under the energy saving mode, press the Mode key to select Energy Saving until the corresponding icon gets flickering, and then press the "OK" key within 5 seconds to validate the setting, with the icon of "Energy Saving" extinguished and the energy saving function disabled.
- ◆ When the Quick Freezing function is enabled, the energy saving function will be disabled automatically.

1.4 Child Lock

When the Child Lock function is enabled, the temperature and function are subjected to no change to prevent maloperation.

1) In case of no key operation within 3 minutes, the Child Lock function will be enabled automatically.

2) Enabling / Exiting the Child Lock function manually

- ◆ Press and hold down the OK key for 3s, then the Child Lock function can be enabled / disabled.

1.5 Door open alarm

If any door is open for more than 3 minutes, buzzer alarms will be continuously issued, which can be stopped when any key is pressed, but will be restored after 3 minutes if the door keeps open. The alarms will not be lifted until the door is closed.

1.6 Power cut memory

In the case of power failure, the refrigerator will maintain the running state that is set before the power outage when the power supply is restored.

1.7 Power-on delay

In order to protect the refrigerator compressor from being damaged in the case of short-time power failure (i.e., less than 5 minutes), the compressor will not be started immediately after it is powered on.

1.8 Fault alarm

In case E0, E1, E2, EH, or EC, etc. is displayed on the operation panel, it indicates fault with the refrigerator. Please contact the aftersales person for visiting service in such case.

Instructions for food storage

Precautions for use

- The appliance might not operate consistently (there is possibility of defrosting or temperature becoming too warm in the frozen food compartment) when sited for an extended period of time below the cold limit of the temperature range for which the refrigerating appliance is designed
- The information of climate type of the appliance is provided on the rating plate.
- The internal temperature could be affected by such factors as the location of refrigerating appliance, ambient temperature, and frequency of door open, etc., and if appropriate, a warning that setting of any temperature control device might have to be varied to allow for these factors should be made.
- Effervescent drinks should not be stored in the freezer compartment or the low-temperature compartment, and some products such as water ices should not be consumed too cold.

Food storage location

Due to the cold air circulation in the refrigerator, the temperature of each area in the refrigerator is different, so different kinds of food should be placed in different areas. The fresh food compartment is suitable for the storage of such foods as need not to be frozen, the cooked food, beer, eggs, some condiments that need cold preservation, milk, fruit juice, etc. The crisper box is suitable for the preservation of vegetables, fruits, etc. The freezer compartment is suitable for the storage of ice cream, frozen food and the foods to be preserved for a long time.

Use of the fresh food compartment

Fridge shelf: When removing the shelf, lift it up first, and then pull it out; and when installing the shelf, place it into position before putting it down. Keep the shelf rear flange upward, to prevent foods from contact the liner wall. When taking out or putting in the shelf, hold it firmly, and handle with care to avoid damage.

Crisper box: Pull out the crisper box for access to food. After using or cleaning the cover plate of the crisper box, be sure to put it back onto the crisper, so that the internal temperature of the crisper box will not be affected.

Use of the crisper humidity regulating rod

The humidity regulating rod of the crisper box is design to maintain the humidity and freshness of the vegetables stored inside. When the humidity regulating rod is slide to the right, with more holes exposed, lower humidity will be kept inside the crisper box. When the humidity regulating rod is slide to the left, with less holes exposed, higher humidity will be kept inside the crisper box.

Cautions for food storage

You'd better clean the foods and wipe them dry before storing them inside the refrigerator. Before foods are put in the refrigerator, it is advisable to seal them up, so as to prevent water evaporation to keep fresh fruits and vegetables on one hand, and prevent taint of odor on the other hand.

Do not put too many or too weight foods inside the refrigerator. Keep enough space between foods; if too close, the cold air flow will be blocked, thus affecting the refrigeration effect. Do not store excessive or overweight foods, to avoid the shelf from being crushed. When storing the foods, keep a distance away from the inner wall; and do not place the water-rich foods too close to the fridge rear wall, lest they get frozen on the inner wall.

Categorized storage of foods: Foods should be stored by category, with the foods you eat every day placed in front of the shelf, so that the door open duration can be shortened and food spoilage due to expiration can be avoided.

Energy-saving tips: Allow the hot food cool down to the room temperature before putting it in the refrigerator. Put the frozen food in the fresh food compartment to thaw, using the low temperature of the frozen food to cool the fresh food, thus saving energy.

Storage of fruits and vegetables

In the case of refrigerating appliances with chill compartment, a statement to the effect that some types of fresh vegetables and fruits are sensitive to cold and therefore are not suitable for storage in this kind of compartment should be made.

Use of the frozen food storage compartment

The freezer temperature is controlled below -18°C , and it is advisable to store the food for long-term preservation in the freezer compartment, but the storage duration indicated on the food packaging should be adhered to.

The freezer drawers are used to store food that needs to be frozen. Fish and meat of large block size should be cut into small pieces and packed into fresh-keeping bags before they are evenly distributed inside the freezer drawers.

Quick Freezing

- (1) Refer to the description about Quick Freezing function in the "Function" section.
- (2) Compared with the normal freezing, Quick Freezing enables food to pass through the maximum ice crystal formation zone at the fastest speed. Quick Freezing can freeze the food water content into fine ice crystals, without damaging the cell membrane, so cell juice will not be lost when thawing, and the original freshness and nutrition of food can be maintained.
- (3) The Quick Freezing function is designed to preserve nutrition of the frozen food, with the food thoroughly frozen in the shortest time. Quick Freezing consumes more energy than the normal freezing does.

★ Allow the hot foods to cool down to the room temperature before putting them in the freezer compartment.

★ Do not put a glass container with liquid or the canned liquid that is sealed in the freezer compartment, so as to avoid burst due to volume expansion after the liquid gets frozen up.

★ Divide the food into appropriately small portions

★ You'd better pack the food up before freezing it, and the packing bag used should be dry, in case the packing bags are frozen together. Foods should be packed or covered by such suitable materials as are firm, tasteless, impervious to air and water, non-toxic and pollution-free, to avoid cross-contamination and transfer of odor.

Tips for special needs

Moving the refrigerator / freezer

● Location

Do not place your refrigerator / freezer near a heat source, e.g. cooker, boiler or radiator. Avoid it from direct sunlight in out-buildings or sun lounges.

● Leveling

Make sure to level your refrigerator / freezer using the front leveling feet. If not level, the refrigerator / freezer door gasket sealing performance will be affected, or even it may lead to the operating failure of your refrigerator / freezer. After locating the refrigerator / freezer in position, wait for 4 hours before using it, so as to allow the refrigerant to settle.

● Installation

Do not cover or block the vents or grilles of your appliance. When you are out for long time

- If the appliance will not be used for several months, turn it off first, and then unplug the plug from the wall outlet.
- Take out all foods.
- Clean and dry the interior thoroughly. To prevent odor and mold growth, leave the door ajar : block it open or have the door removed if necessary.
- Keep the cleaned appliance in a dry, ventilated place and away from the heat source, place the appliance smoothly, and do not place heavy objects on top of it.
- The unit should not be accessible to child's play.

How to use the ice-making box

Place the ice-making box in the upper position of the freezer compartment, so that it ices up as soon as possible.

Maintenance and cleaning

! Before cleaning, unplug the power plug first; Do not plug in or plug out the plug with wet hand, because there is a risk of electric shock and injury. Do not spill water directly on the refrigerator, to avoid rust, electricity leakage and accidents. Do not stretch your hands into the bottom of the refrigerator, since you might be scratched by sharp metal corners.

Internal cleaning and external cleaning

- The food residuals in the refrigerator are liable to produce bad odor, so the refrigerator must be cleaned regularly. The fresh food compartment is usually cleaned once a month.
- Remove all shelves, crisper box, bottle racks, cover board, and drawers etc., and clean them with a soft towel or sponge dipped in warm water or neutral detergent.
- Clear off the dusts accumulated on the rear panel and side plates of the refrigerator often.
- After using detergent, be sure to rinse it with clean water, and then wipe it dry.

! Do not use bristle brush, steel wire brush, detergent, soap powder, alkaline detergent, benzene, gasoline, acid, hot water and other corrosive or soluble items to cleanse the cabinet surface, door gasket, plastic decorative parts, etc., so as to avoid damage.

Carefully wipe dry the door gasket, clean the groove using a wooden chopstick wrapped with cotton string. After the cleaning, fix the four corners of the door gasket first, and then embed it segment by segment into the door groove.

Interruption of power supply or failure of the refrigerating system

- Take care of the frozen foods in the event of an extended non-running of the refrigerating appliance (such as interruption of power supply or failure of the refrigerating system).
- Try to open the refrigerator door as less as possible, in this way can food safely and freshly kept for hours even in hot summer.
- If you get the power outage notice in advance:
 - 1) Adjust the thermostat knob to the high mode an hour in advance, so that foods get fully frozen (Do not store new food during this time!).
Restore the temperature mode to the original setting when power supply becomes normal in a timely manner.
 - 2) You can also make ice with a watertight container, and put it in the upper part of the freezer, so as to extend the time for fresh food to be stored.

! Note: Once the refrigerator is used, you'd better use it continuously; and under normal circumstance, do not stop its use, so as not to affect the service life.

● Defrosting

This appliance is designed with automatic defrosting function, thus no need to defrost it manually.

● Changing the lamp

The LED lamp is used by the refrigerator for lighting, which features low energy consumption and long service life. In case of any abnormality, please contact the after-sales personnel for visiting service. The lamps can only be replaced by the manufacturer.

Lamp type : LED light.

Energy efficiency level : G

● Safety-check after maintenance

Is the power cord broken or damaged ?

Is the power plug firmly inserted into the socket ?

Is the power plug abnormally over heated ?

⚠ Note: Electric shock and fire accident may be caused in case the power cord and plug is damaged or stained by dust. If any abnormality, please unplug the power plug and get in contact with the vendor.

● How to disassemble the parts.



Fridge door bottle rack :

Press both sides of the bottle frame by hand and lift it up.

Simple fault analysis and elimination

Regarding the following small faults, note very failure needs to be fixed by the technical service personnel; you can try to solve the problem.

Case	Inspection	Solutions
• Completely not refrigerating	• Is power plug off ? • Are breakers and fuses broken ?	• Re-plug • Opening the door and checking whether the lamp is lit.
	• No electricity or line trip ?	
• Abnormal noise	• Is refrigerator stable ? • Does refrigerator contact the wall ?	• Adjusting refrigerator's leveling feet. • Off the wall.
• Poor refrigerating efficiency	• Do you put hot food or too much food ? • Do you open the door frequently ? • Do you clip food bag to the door gasket ? • Direct sunlight or near a furnace or stove ? • Is it well-ventilated ? • Temperature setting in too high ?	• Putting food into refrigerator when hot food becomes cool. • Checking and closing the door. • Removing the refrigerator from the heat source. • Emptying the distance to maintain good ventilation. • Setting at the appropriate temperature.
• Peculiar smell in refrigerator	• Any spoiled food ? • Do you need to clean refrigerator ? • Have you packed food of strong flavors ?	• Throwing away spoiled food. • Cleaning refrigerator. • Packing food of strong flavors.
• No key response	• Check whether the Child Lock function is enabled on the display panel.	• Press & hold the "Function/3s to Unlock" key for 3 seconds to unlock the key, and then conduct the key operation. (For details, refer to the Child Lock function.)

⚠ Note: If the above descriptions are inapplicable to troubleshooting, do not disassemble and repair it yourself. Repairs carried out by inexperienced persons may cause injury or serious malfunctioning. Contact the local store where your purchase was made. This product should be serviced by an authorized engineer and only genuine spare parts should be used.

When the appliance is not in use for long periods, disconnect from the electricity supply, empty all foods, and clean the appliance, leaving the door ajar to prevent unpleasant smells.

Certifications

Electrical information

- This electrical appliance must be grounded
- This product is equipped with a plug, which is suitable for all houses equipped with sockets meeting the current specifications.
- If the fitted plug is not suitable for your socket outlets, it should be cut off and carefully disposed of. To avoid a possible shock hazard, do not insert the discarded plug into a socket.

Safe recovery instructions

Disposal

- Old appliances still have some surplus value. An environmentally friendly approach will ensure that valuable raw materials are recycled.
- The refrigerants used in your equipment and insulation materials require special handling procedures. Make sure there is no pipe damage on the back of the equipment before handling.
- Up-to-date information on the options for disposing of old equipment and packaging from old equipment can be obtained from the local municipal office.

Correct disposal of the product







This marking indicates that this product should not be disposed with other house hold wastes throughout the EU. To prevent possible harm to the environment or human health from uncontrolled waste disposal, recycle it responsibly to promote the sustainable reuse of material resources. To return your used device, please use the return and collection systems or contact the retailer where the product was purchased. They can take this product for environmentally safe recycling.

Warnings for disposal

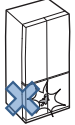
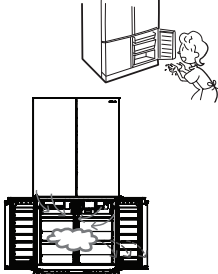
- ※ Refrigerant and cyclopentane foaming material used for the refrigerator are flammable. Therefore, when the refrigerator is scrapped, it shall be kept away from any fire source and be recovered by a special recovering company with corresponding qualification other than be disposed by combustion, so as to prevent damage to the environment or any other harm.
- ※ When the refrigerator is scrapped, disassemble the doors, and remove gasket of door and shelves; put the doors and shelves in a proper place, so as to prevent trapping of any child.

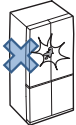
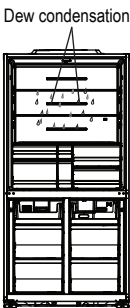
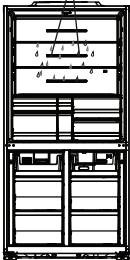
Dew or Frost is generated

General operation	Please check here	Possible causes and / or Recommended solutions
Frost or ice is generated in the freezer compartment	The door of the freezer compartment was not left open temporarily?	Check that the wrapping paper of the food is not getting caught in order not to make gap between door and door gasket when you close the door. 
	The door of the freezer compartment was not opened frequently or longer time than necessary?	When the door is opened frequently or if the door is opened when the humidity around the refrigerator is high, moisture in the air may be turned into some frost or ice on the inner wall or component of the freezer compartment, or around the air channels. This is not a failure. Please try not to open the door too many times or for a long time. Also, please wipe frost or ice generated in the freezer compartment off with use of a dry cloth. 
	Making extra ice by using an additional ice-tray which was not originally installed in the refrigerator?	When the many containers in which water or liquid is stored are put in the same time, water or liquid may be evaporated and turned into frost or ice on the wall or component of the freezer compartment, or around the air channels. You can suppress these frost and ice by putting lid to avoid evaporation. Please wipe frost and ice off with use of a dry cloth. 
Dew is generated in the refrigerator compartment	The door of the refrigerator compartment was not left open temporarily?	Please check not to pinch the food or plastic bag between the door and door frame when you close the door. 
	The door of the refrigerator compartment was not opened frequently or longer time than necessary?	When the door is opened frequently or if the door is opened when the humidity around the refrigerator is high, moisture in the air may be turned into some dew on the inner wall or component of the refrigerator compartment, or around the chilled air blow-off port. This is not failure. Please try not to open the door too many times or for long time. Also, please wipe off the dew in the refrigerator compartment with adry cloth. 
	Storing many vegetables containing much water?	The humidity of the vegetable compartment is higher than other compartments. Accordingly, depending on the amount or type of the vegetable, dew condensation may be generated on the plastic case of vegetable compartment. However, this is not a failure. When you do not want to have this kind of dew, please warp your vegetables in a plastic film. Also, when the dew condensation happens many times, water may be accumulated in the vegetable compartment. Please wipe the water off with a dry cloth. 
Dew is generated on outer surface of the refrigerator	The volume of humidity around the refrigerator is not high?	When the humidity rises such as in rainy day, some dew many be generated on the outer surface of the refrigerator. Please wipe the dew off with a dry cloth. 
	The temperature setting is not set as "Coldest"?	When the temperature setting is set as "Coldest", some dew may be generated on the outer surface of the refrigerator. Please set the setting as "Normal". Also, please wipe dew off with use of a dry cloth. 

Why frost and dew are generated?

When warm and humid air contacts something cold, dew is generated. For example, if you put some ice in the glass in your room, air around the glass will be cold down and some dew may be generated on the outer surface of the glass.

In the same way, when warm and humid air enters into the refrigerator at the door opening, the warm and humid air contacts cold inner wall and little dew may be generated.

Accordingly, if the door opening is too frequent or too long, dew will be accumulated at every door opening. In some cases, dew may be frozen to generate some frost or ice flakes in the freezer compartment.

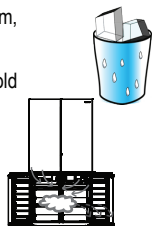

Service Center

- Before you request repair, please check the refrigerator well according to page number 10. If it is still abnormal, please contact the retailer of purchase or the following service center.

Service Center	TEL No.
<ul style="list-style-type: none">• Arcelik Hitachi Home Appliances Sales Malaysia Sdn.Bhd.• Arcelik Hitachi Home Appliances Sales (Singapore) Pte. Ltd	<ul style="list-style-type: none">• 1-800-88-1122• 62787177

About Non-fluorocarbon refrigerator

- This refrigerator, including refrigerant and the heat insulator, is using hydrocarbon (non-fluorocarbon). The hydrocarbon is a material that does not rip up the ozone and have very little influence on global warming. It is the global environment concern material).
- R600a refrigerant is flammable. But the refrigerant is sealed up by the refrigerant circuit, and never leaks by usual use. In case of the refrigerant circuit being damaged by any chance, please avoid using fire or electric product, open the window and ventilate. Afterwards, please contact Hitachi Service Center.

Sever warning signs for Disposal

Cyclopentane is used as in the insulation. The gases in insulation material require a special disposal procedure. Please contact your local authorities in regard to the environmentally safe disposal of this product.



This symbol mark means that used electrical and electronic products shall not be mixed with general household waste. Do not try to dismantle the system and unit by yourself as this could have harmful effects on your health and the environment. Refrigerators must be treated at a specialized treatment facility for recycling and recovery and shall not be disposed of in the municipal waste stream. Please contact the installer, dealer or local authority for more information.